

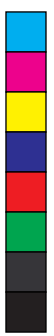

User Manual

AT-628





# Hello.

Congratulations on purchasing your new Relax Massage-chairs.

At Alpha Techno we understand that every body is different and have carefully designed your massage chair with that in mind. But enough about us, this is about you. Learning how to use your new chair is simple (we designed it that way).

So let's get started.

# TABLE OF CONTENTS

Alpha INTRO	Dimensions .....	3
	Contents .....	4
CHAIR	Move & Clearance .....	5
	Components .....	6
	Massage Points .....	7
	Specification .....	8
MASSAGE	Interface .....	9-12
	Pre-Programed Massage .....	13-18
	Demo .....	19-20
	Custom Massage .....	21-25
	Spot Massage .....	26-28
	Settings .....	29-34
	Safety .....	35-36
CARE	Grounding Instruction .....	37
	Troubleshooting .....	37
	Care and Storage .....	38
	Warranty .....	38-39

# DIMENSIONS

First, let's get your chair inside.

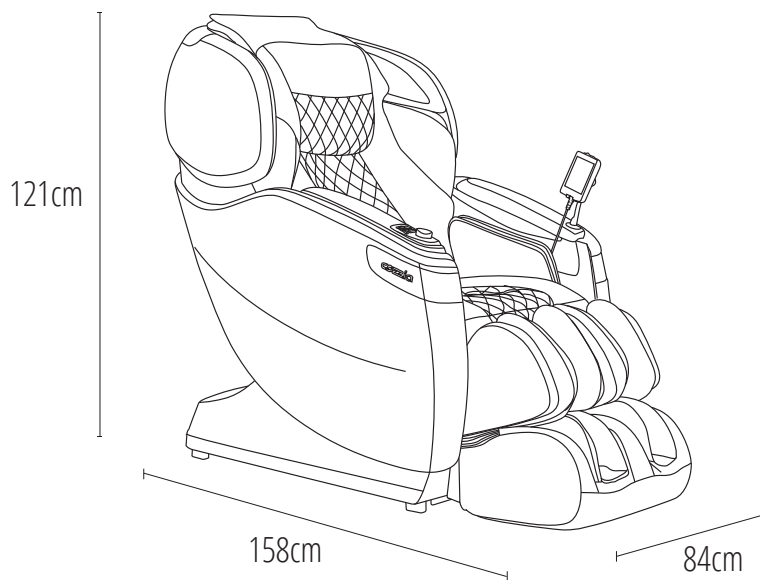

Box 1

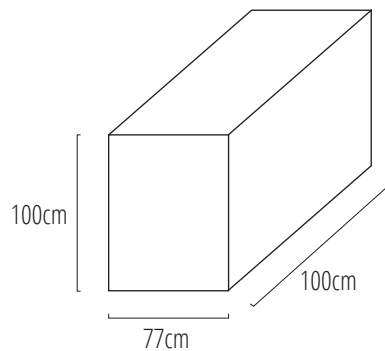

Base & Backrest

Box 2

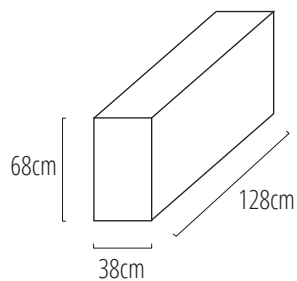

Side Panels

Box 3

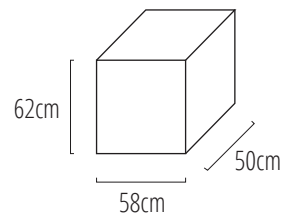

Footrest

# CONTENTS

Everything you need for a relaxing experience.



User Manua

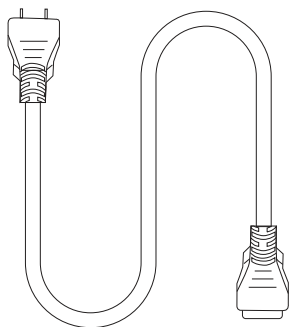

Power Cord

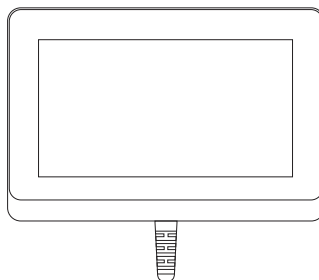

Wired Touch-Pad

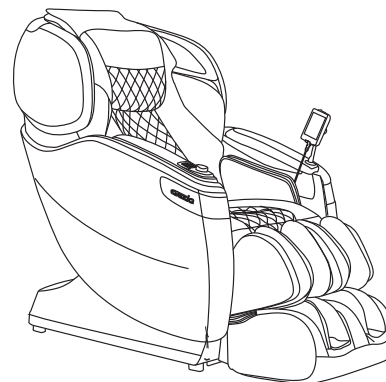

AT-628 Massage-chair

# Move & Clearance

A few simple steps to find the best place for your new chair.

## HOW TO MOVE

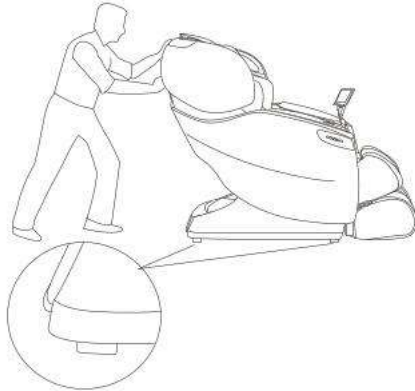

Move with a slight pull or push  
Caution: If you roll the chair on wood floor, marks may be left

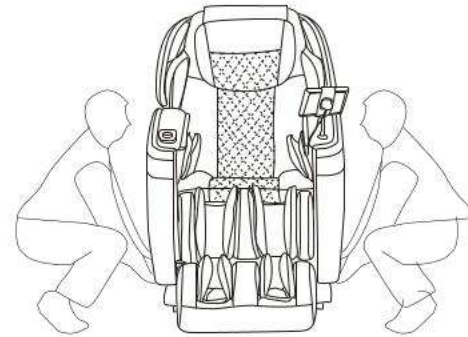

Two people are needed to lift the chair

## CLEARANCE

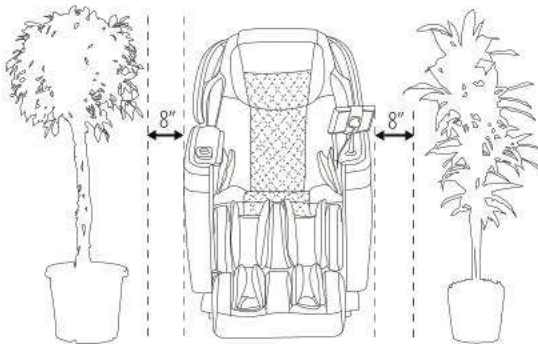

Reserve space on left and right

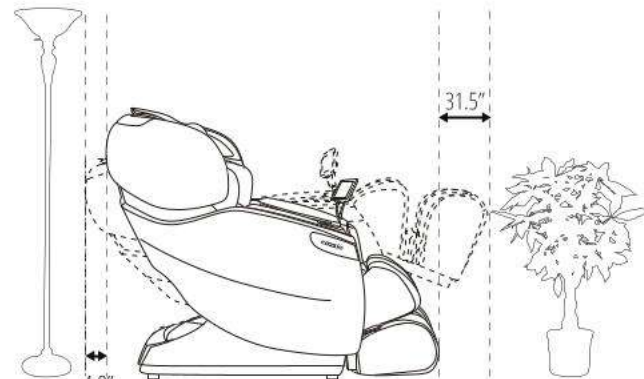

Reserve space on the front and back

# CHAIR COMPONENTS

Some of your chair's most important features.

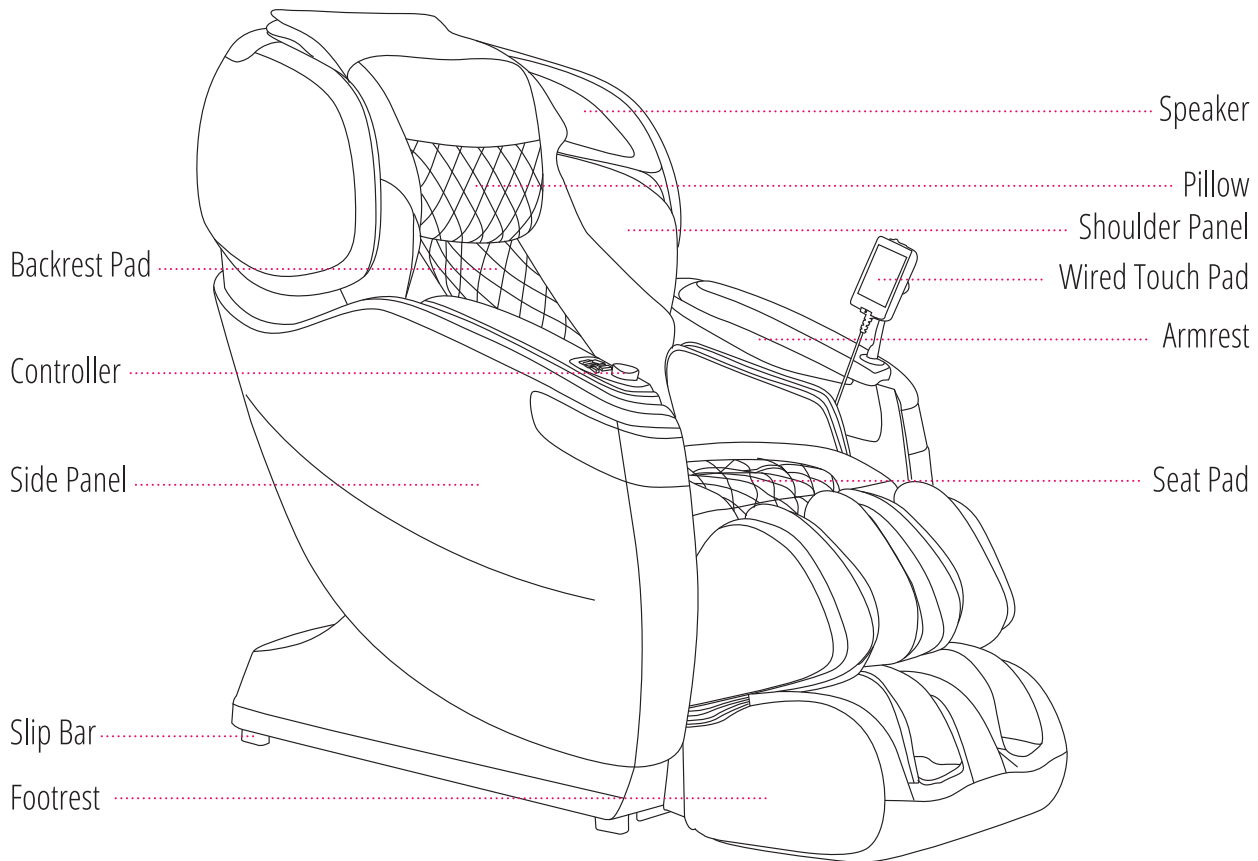

Note: The speaker will only operate when the massage chair is in operation

 To play music using your massage chair's speakers please connect your smartphone, tablet, or other electronic device to your chair using bluetooth.

# MASSAGE POINTS

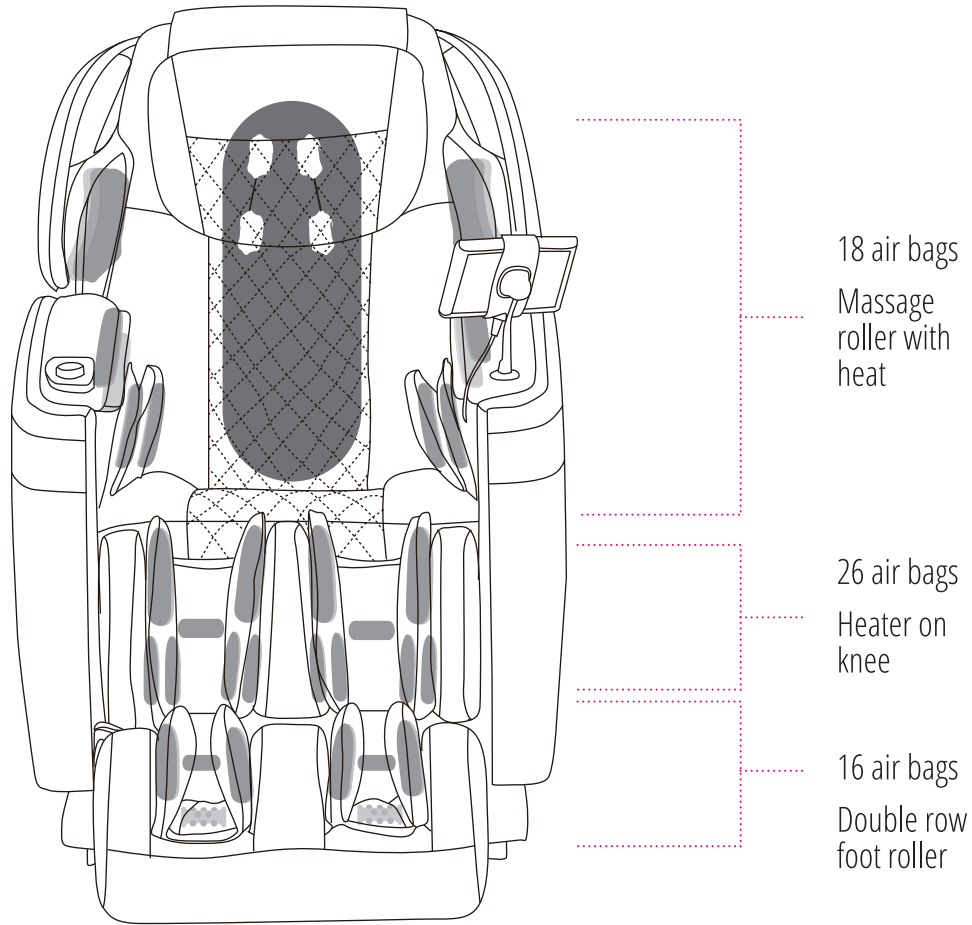

● Back Massage Mode    ● Air Bag    🌀 Roller

# CHAIR SPECIFICATIONS

A few important facts about your massage chair.



## Model No.

AT-628



## Max Massage Time

30 minutes

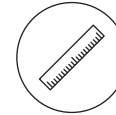

## Dimensions (L x W x H)

Chair Dimension: 158 x 84 x 121cm  
Reclined Dimension: 196 x 84 x 105cm



## Shipping Weight

Gross weight: 146kg  
Net Weight: 122kg

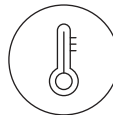

## Usage Condition

Environment temperature: 10°C-40°C  
Contrasting humidity: 30-85RH

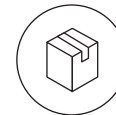

## Storage Condition

Storage temperature: -20°C-60°C  
Storage humidity level: 30-85RH



## Power Consumption

200W



## Rated Voltage

220V



## Rated Frequency

60Hz



## Power of Speakers

14W (2 sides)



## Length of Wiring

Controller wiring 70cm  
Power supply wiring 1.8m



## Safety Feature

Equipped with overheating and power surge detectors safety feature

# WIRED TOUCH-PAD INTERFACE

We have designed your massage chair's tablet controller with a user-friendly interface to make using your chair even easier.

## Home Screen

Setting

Demo

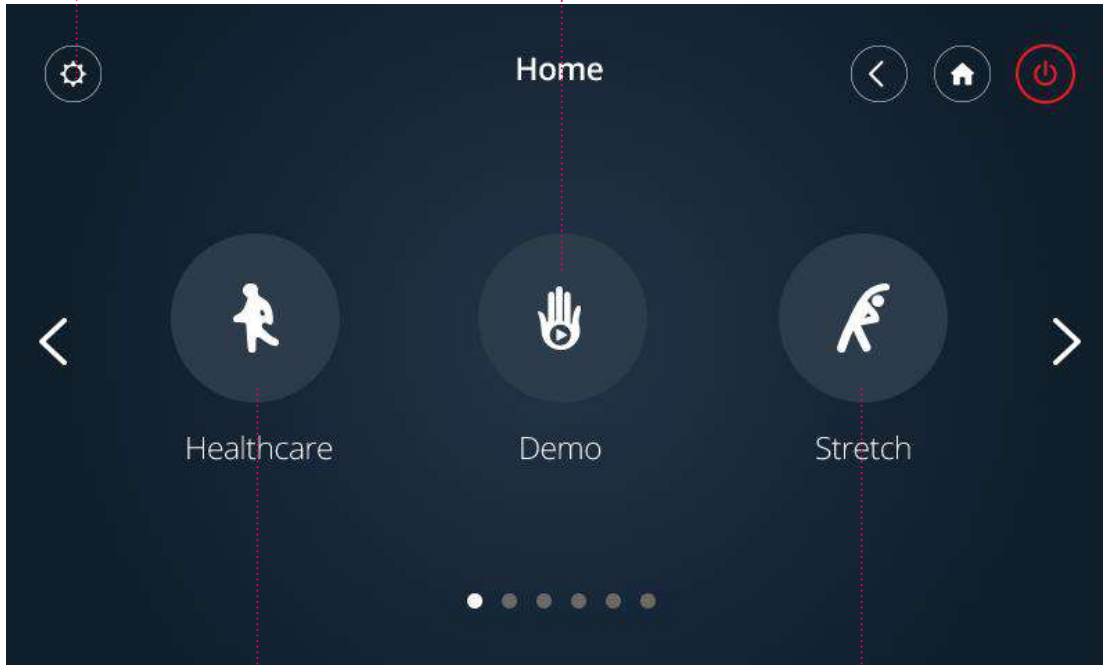

Pre-Programed Massage

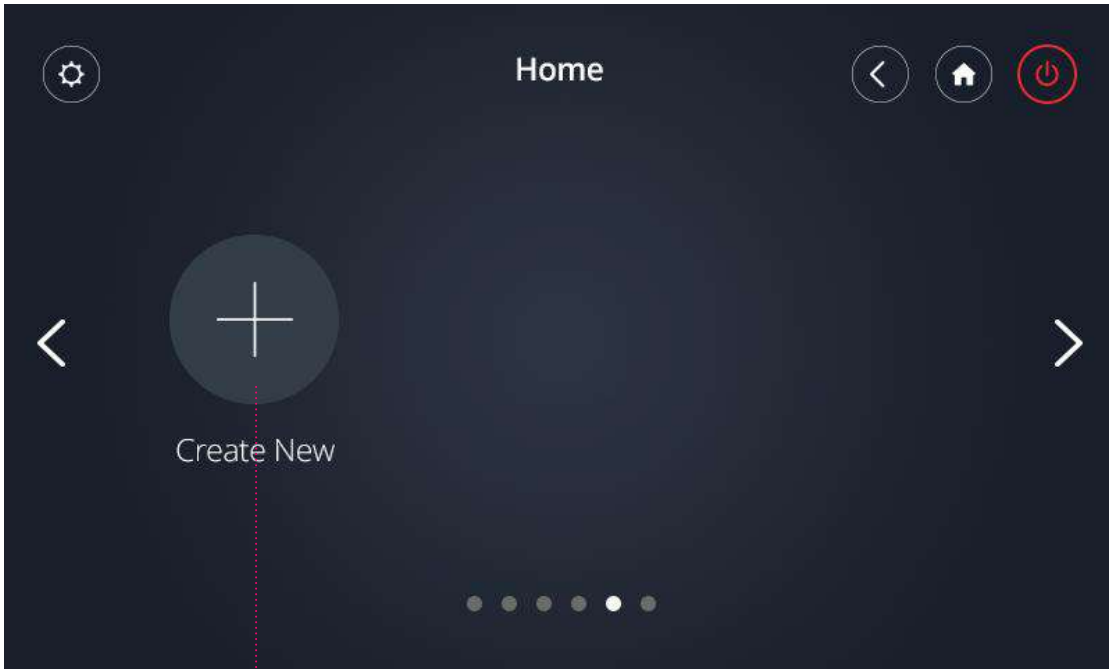

Create New Program

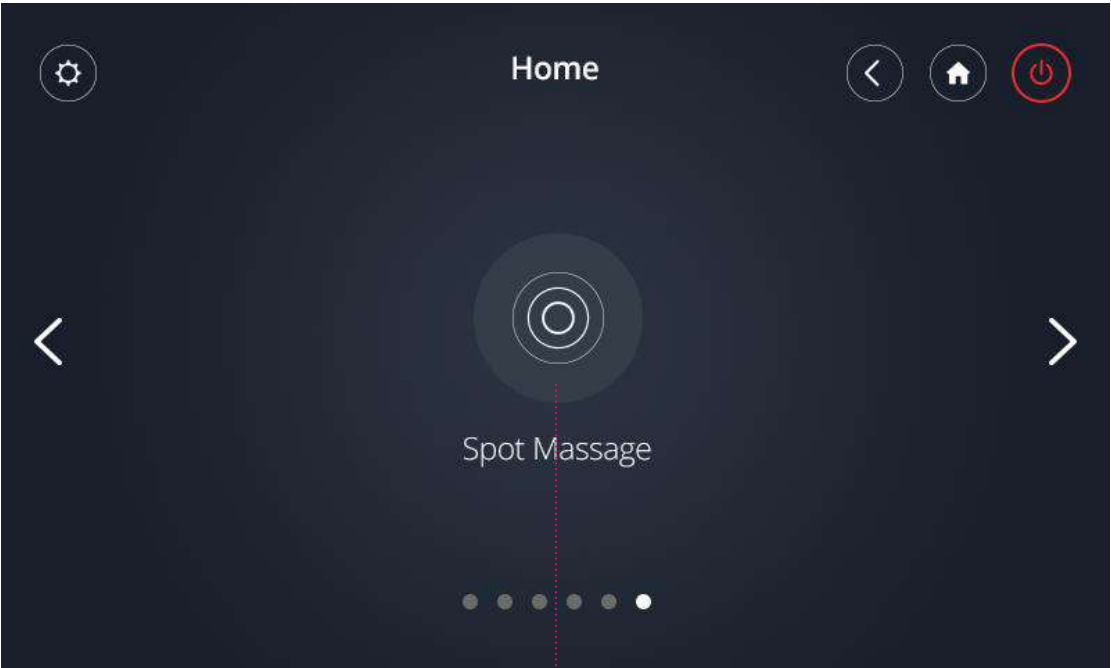

Spot Message

## Massage Controls

Adjust Strength

Name of Program

Time left

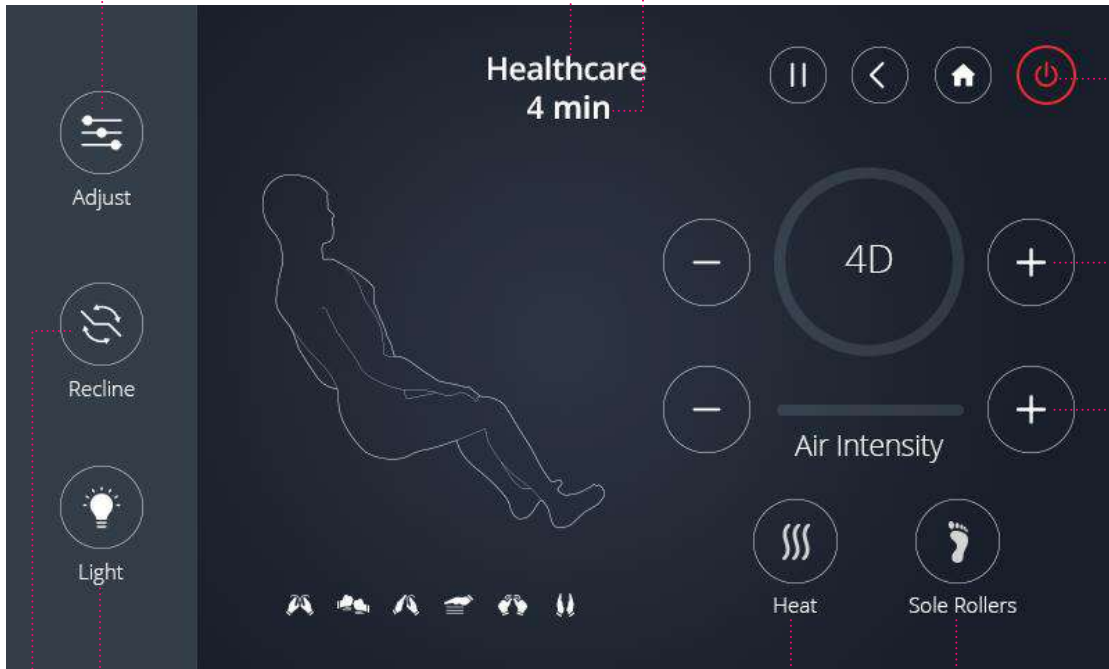

Power

Adjust

Recline

Light

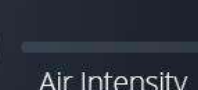

Heat

Sole Rollers

Light Color Variation

Adjust Chair Angle

4D

Air Intensity

Foot Roller

Body Heat/  
Back Heat/  
Leg Heat



# PRE-PROGRAMMED MESSAGE

We have designed your chair with multiple massage options for your changing needs. Follow these simple instructions to begin a new pre-programmed massage.

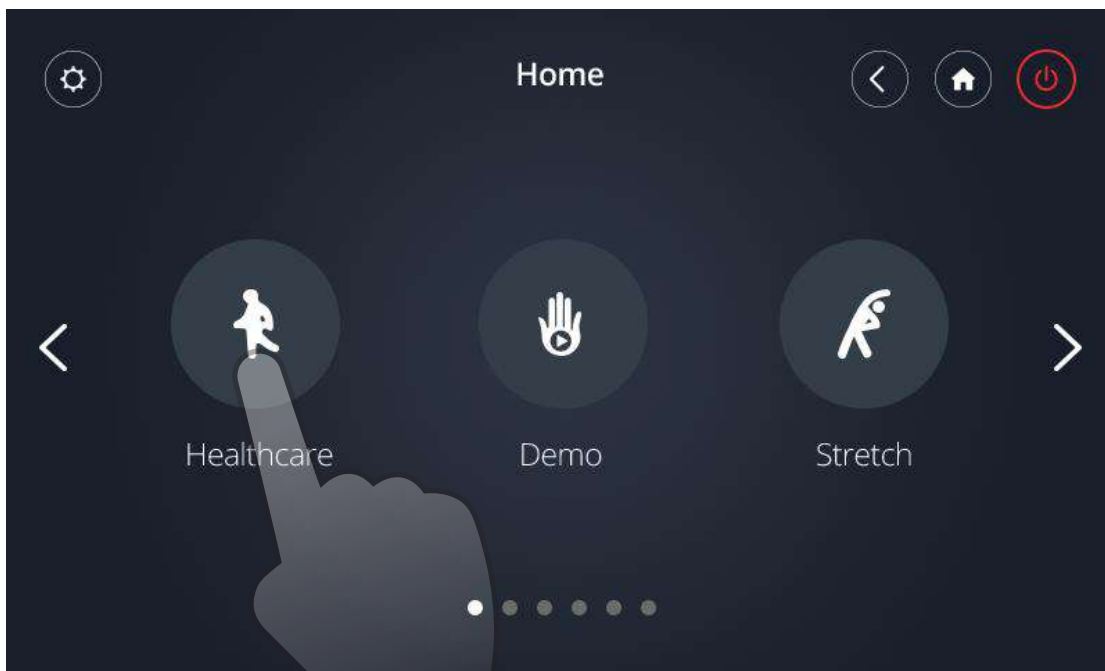

Choose 1 of our 11 pre-programmed massages  
(Gentle, Stretch, Joint Care, Spine Care, Relax, Vigourous, Swedish, Thai, Japanese, Chinese, Balinese)

## Pre-Programmed Massage Interface



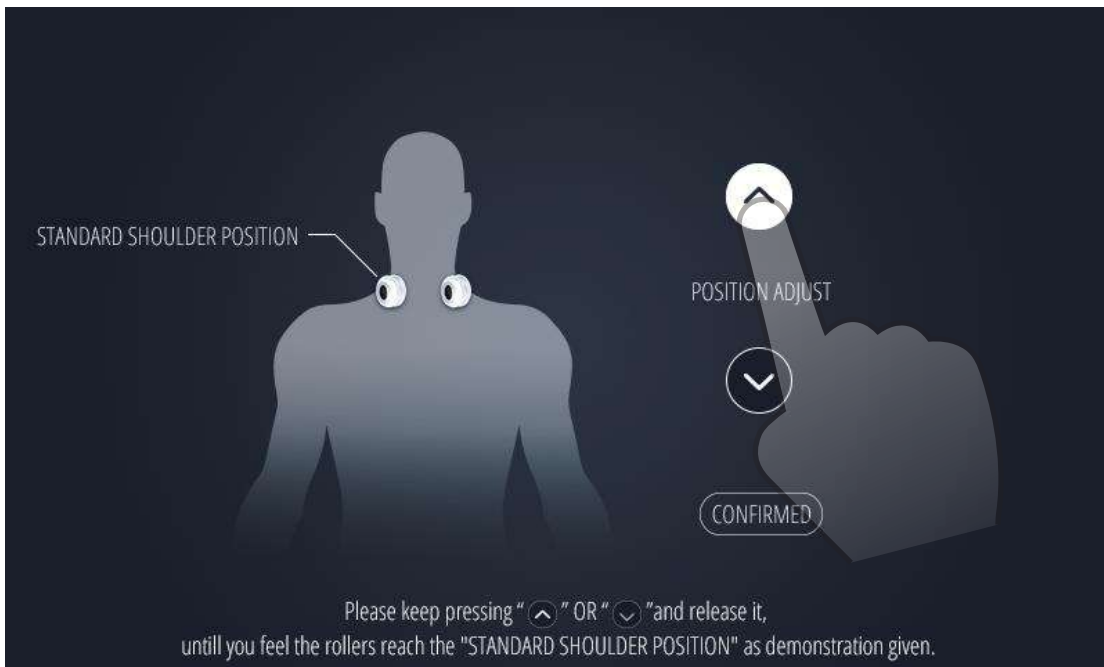

Using the arrows, you can adjust the standard shoulder position

## Adjust Massage Strength Interface

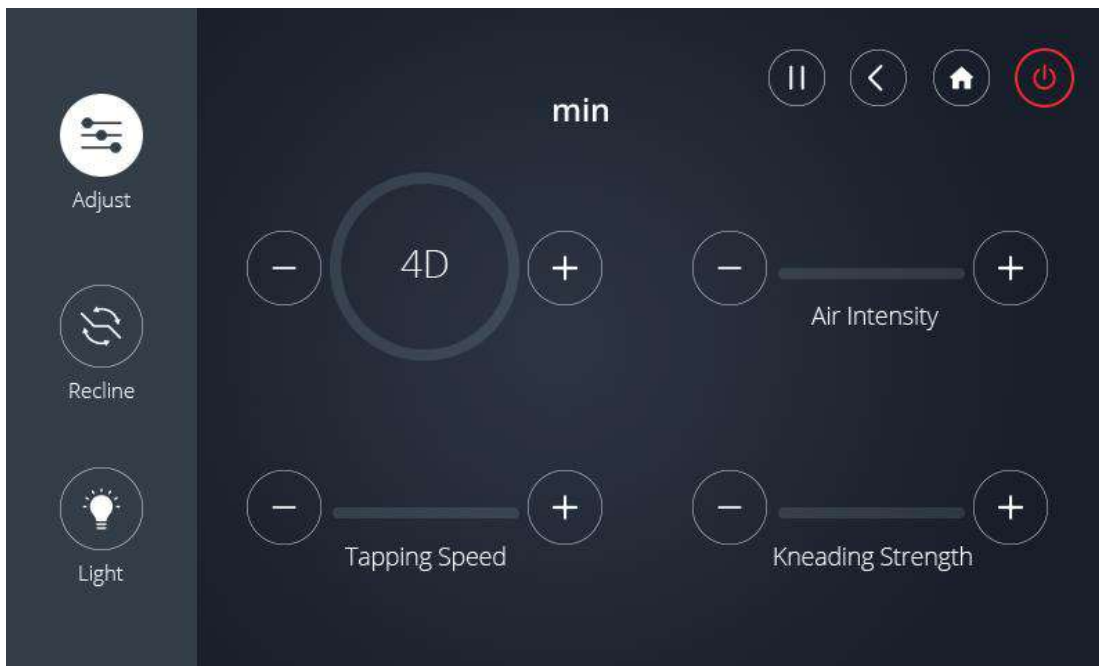

In this interface, you can adjust massage 4D strength, tapping speed, kneading strength and air intensity

## Adjust Chair Angle Interface



Adjust your chair quickly by choosing one of the three preset seating positions. You can also press and hold the arrows to adjust parts of the chair independently

## Change the Light Interface

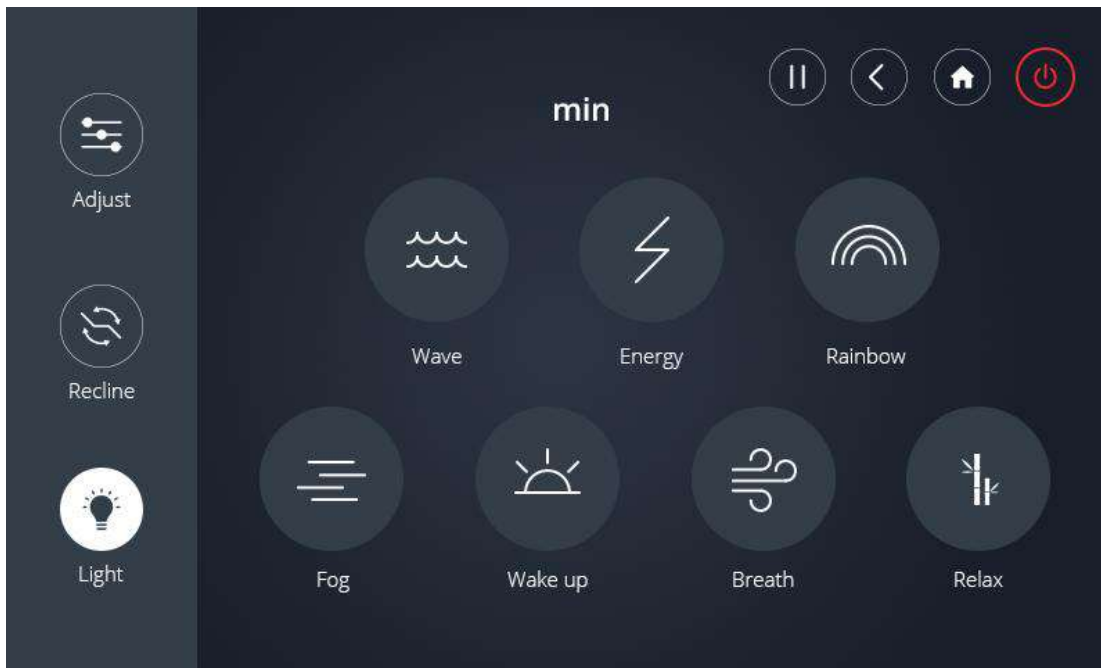

Choose 1 of the 7 types of LED light patterns



# DEMO

In order to allow you to quickly understand the way of massage chair, we created a demo module for you..

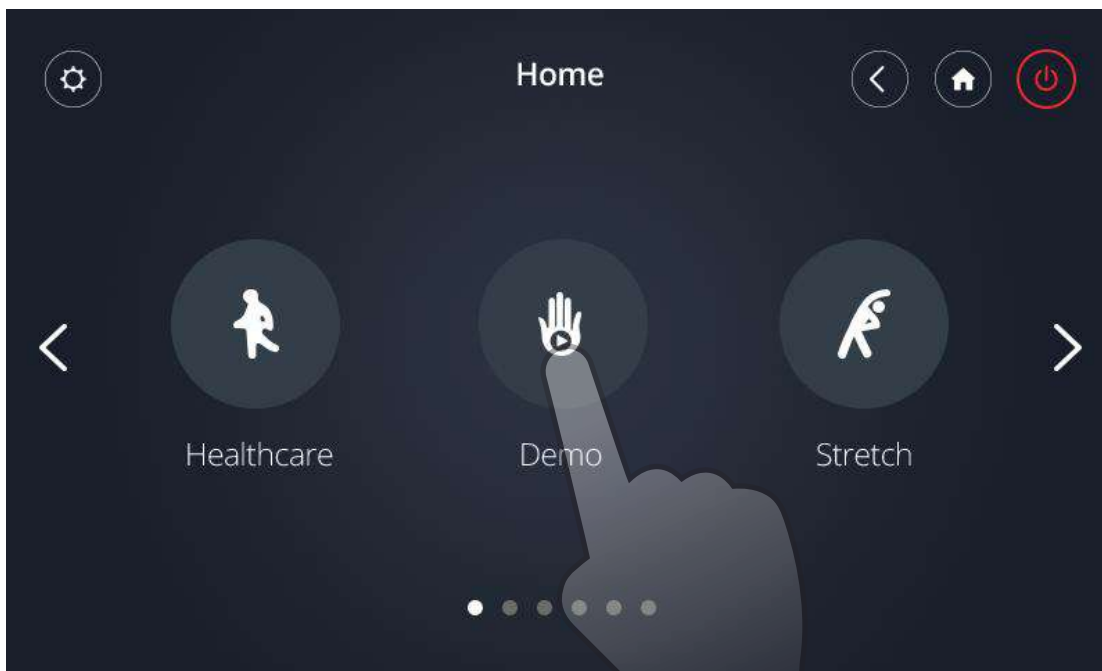

Choose the "Demo" icon to begin demo program

# Demo Interface



# CUSTOM MESSAGE

Every body is different. That's why we've given you the option to customize your message to meet your specific needs. Follow these simple instructions to create a new custom message. You can create up to 3 custom programs. To delete a custom message program, press and hold that icon and choose the "x".

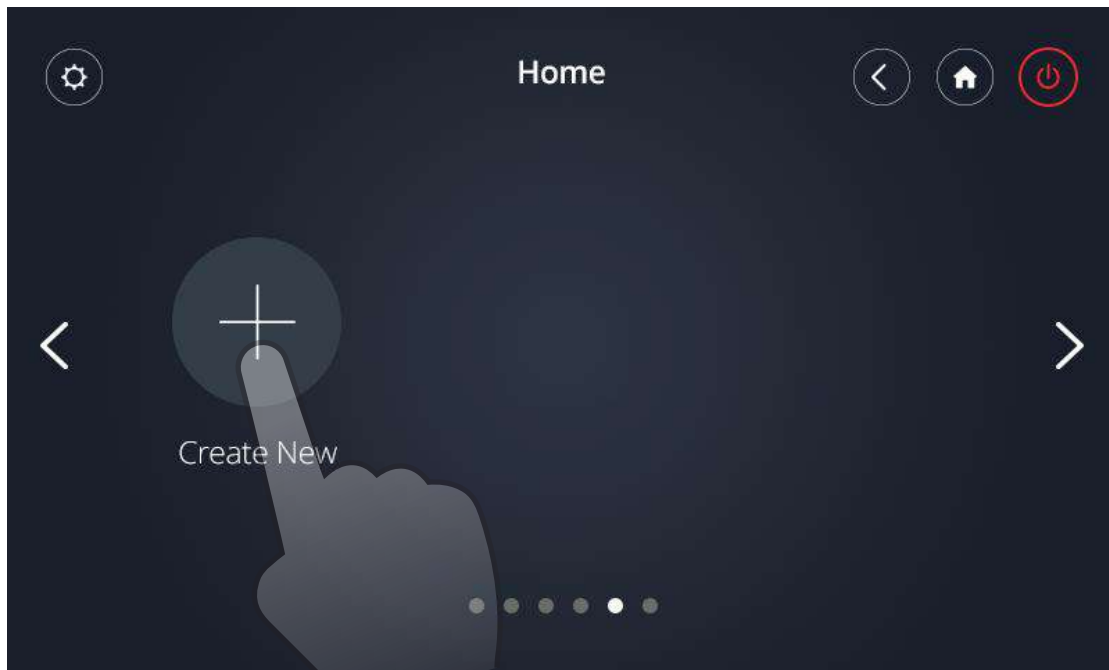

Choose the "Create New" icon to begin creating your message program

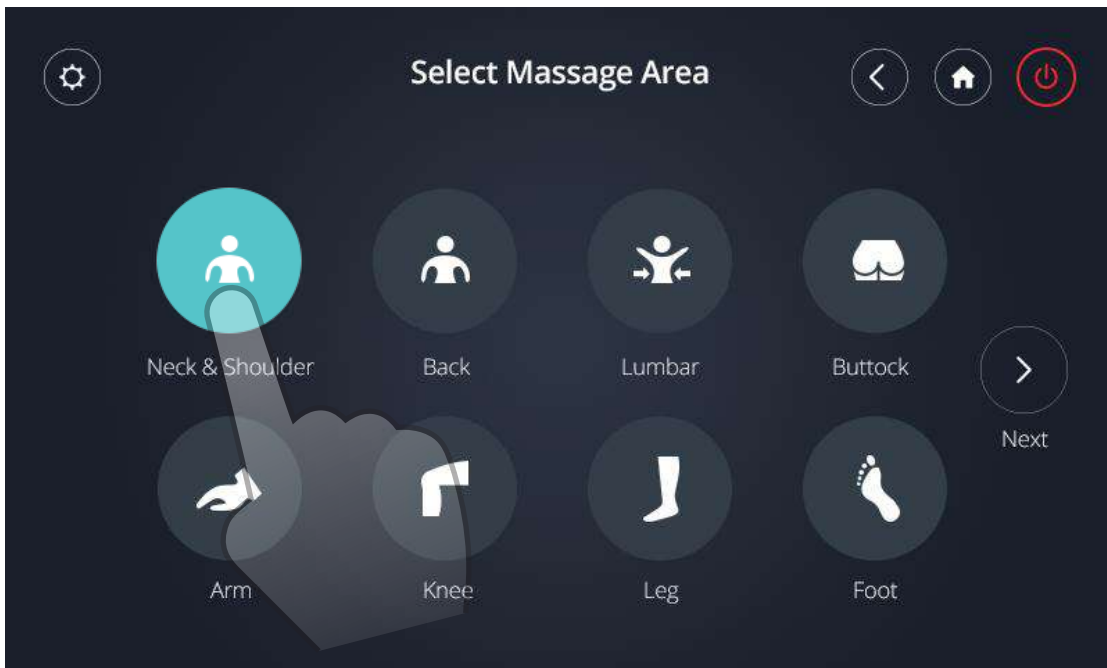

Select your need massage area



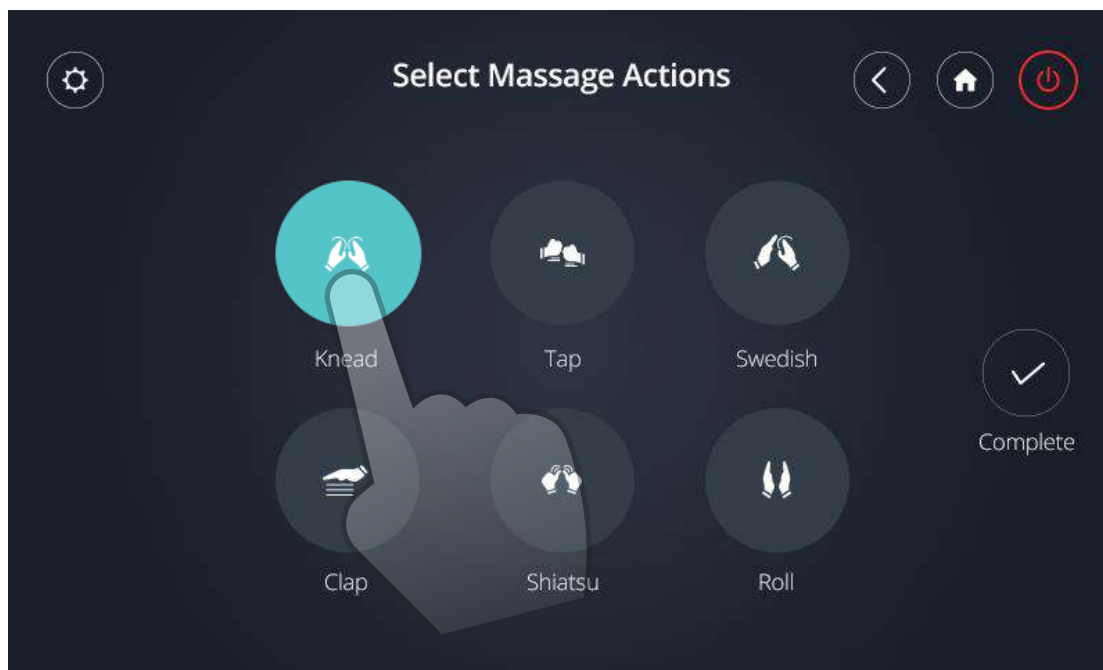

Select your favorite massage actions. The knead, tap, clap, and shiatsu massages can be combined with swedish or roll

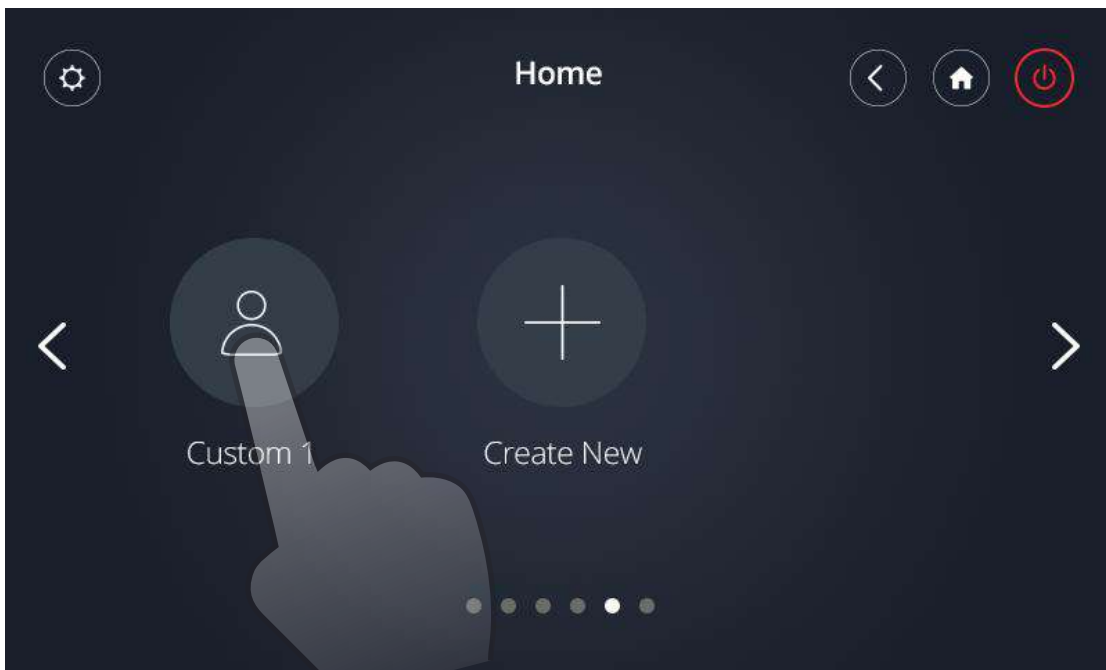

Choose the "Custom 1" icon to start your program

# Custom Interface



# SPOT MESSAGE

This is a fixed message area and actions program

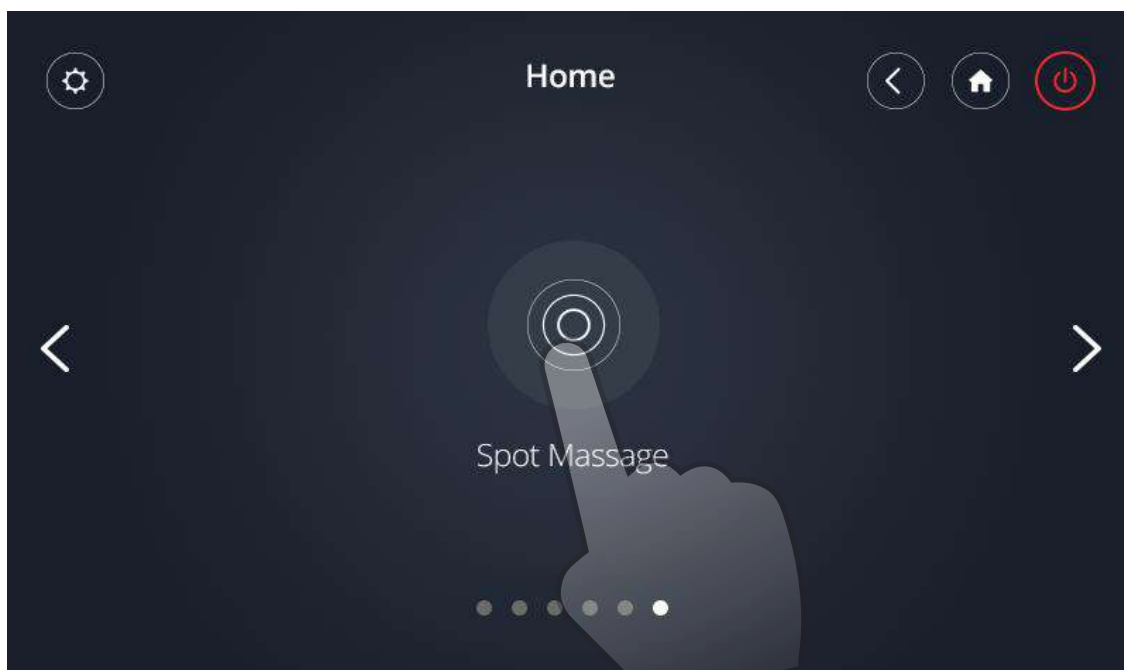

Choose the "Spot Message" button to take you to the Spot Message page

# Spot Massage Interface 1

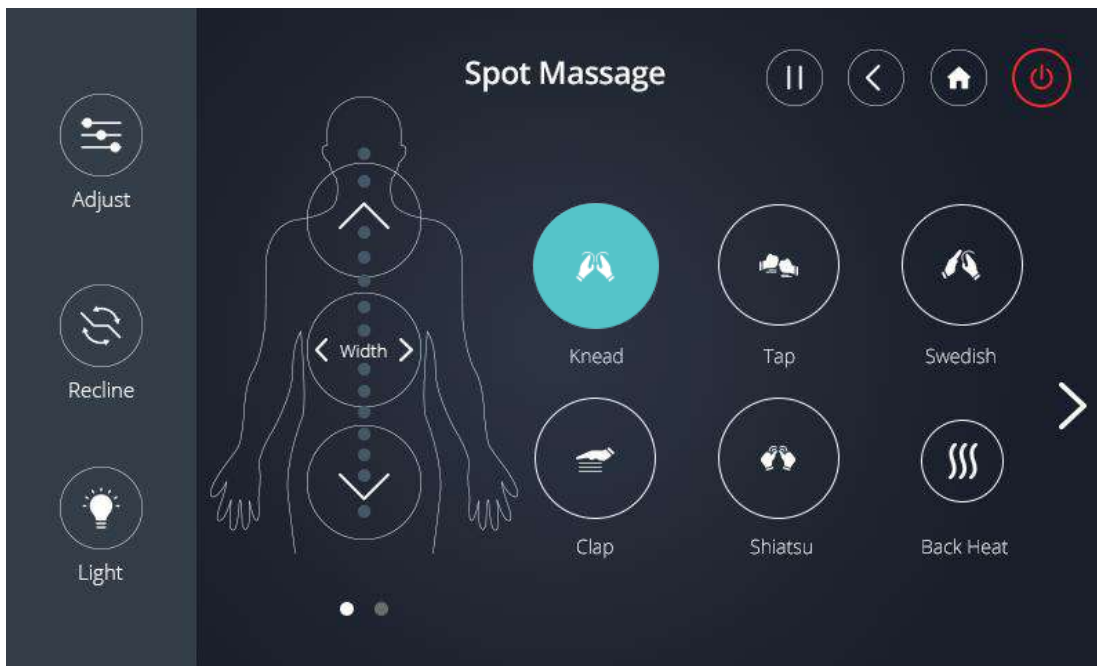

## Spot Massage Interface 2

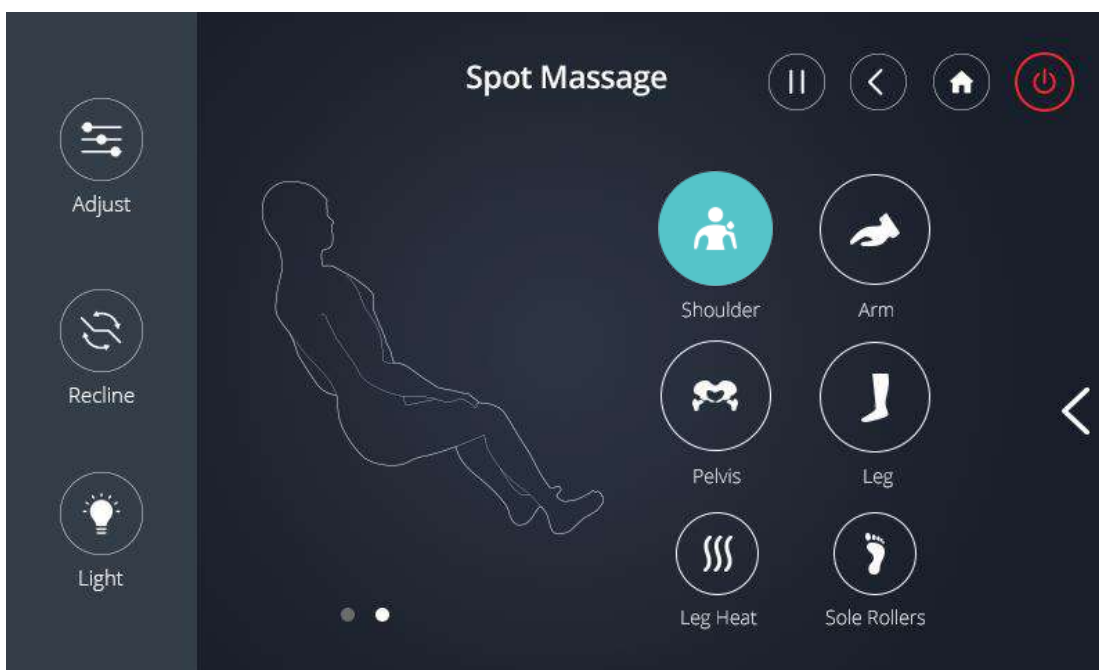

# SETTINGS

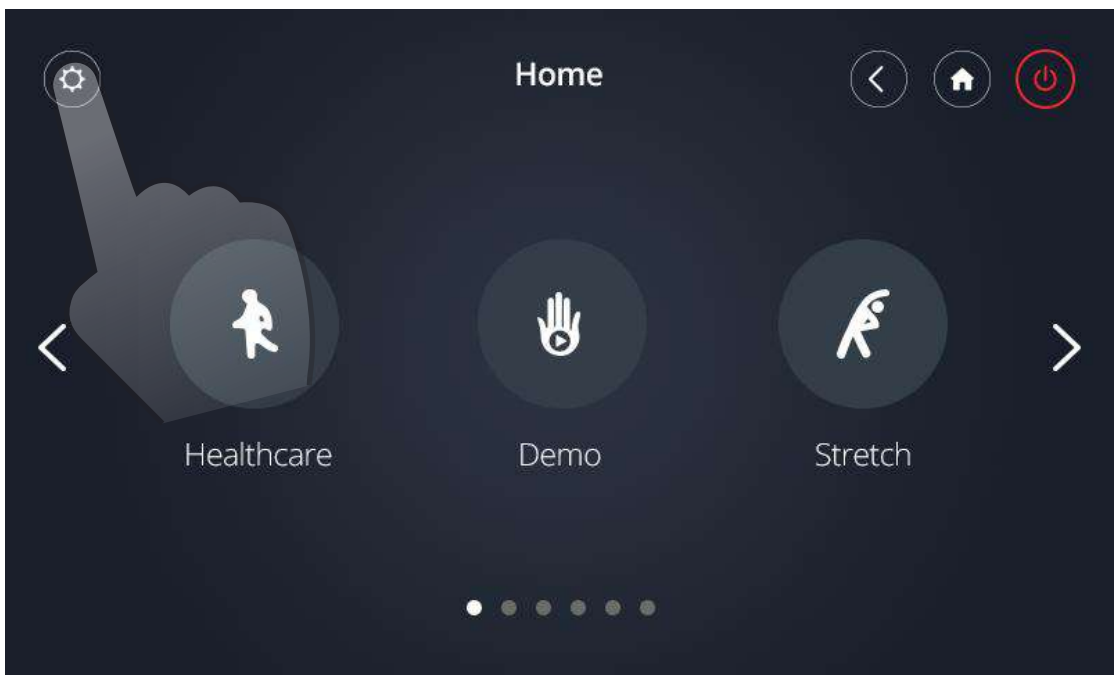

Choose the "Settings" button to take you to the settings page

# Settings Interface

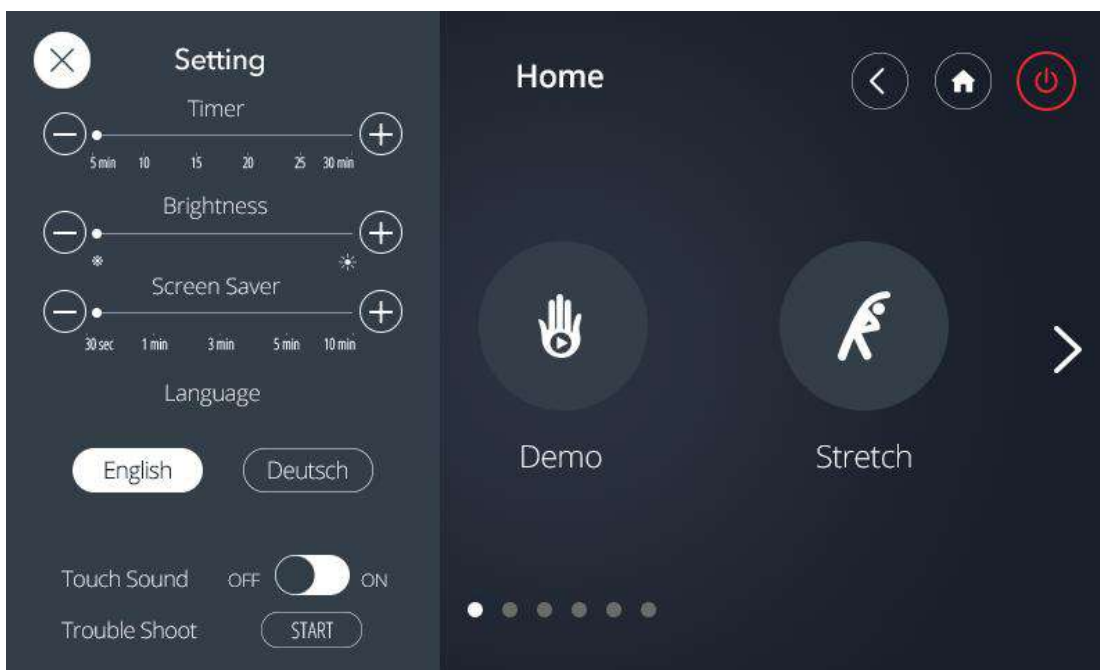

## Trouble Shooting

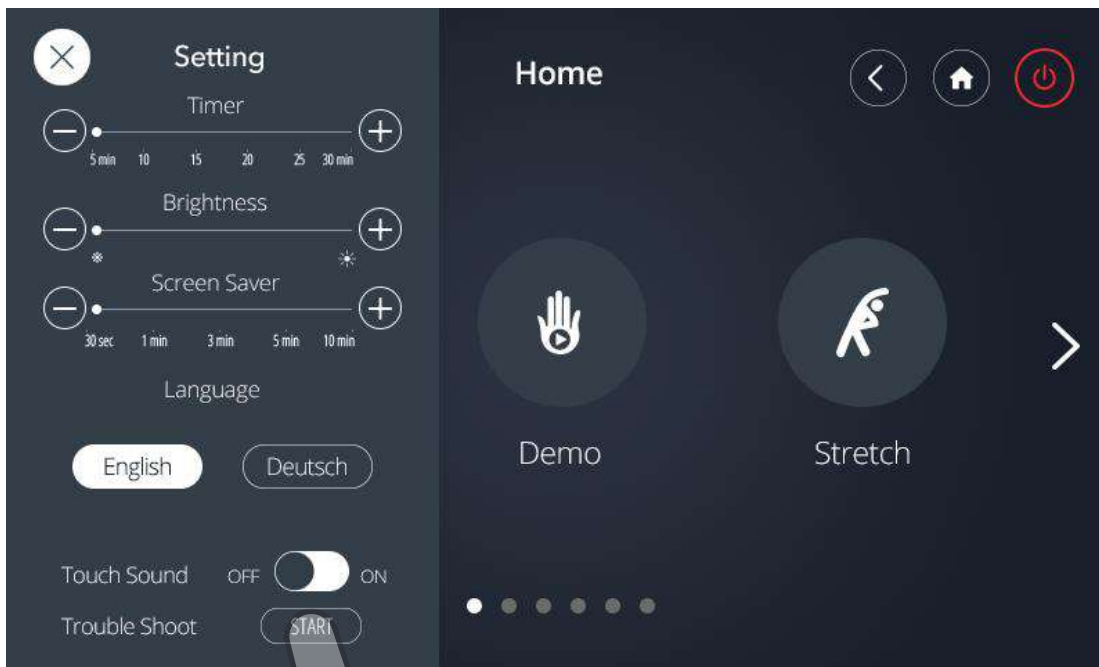

If your chair has any trouble, press the Trouble Shoot "Start" button for the chair to automatically detect problem areas and contact our customer service team

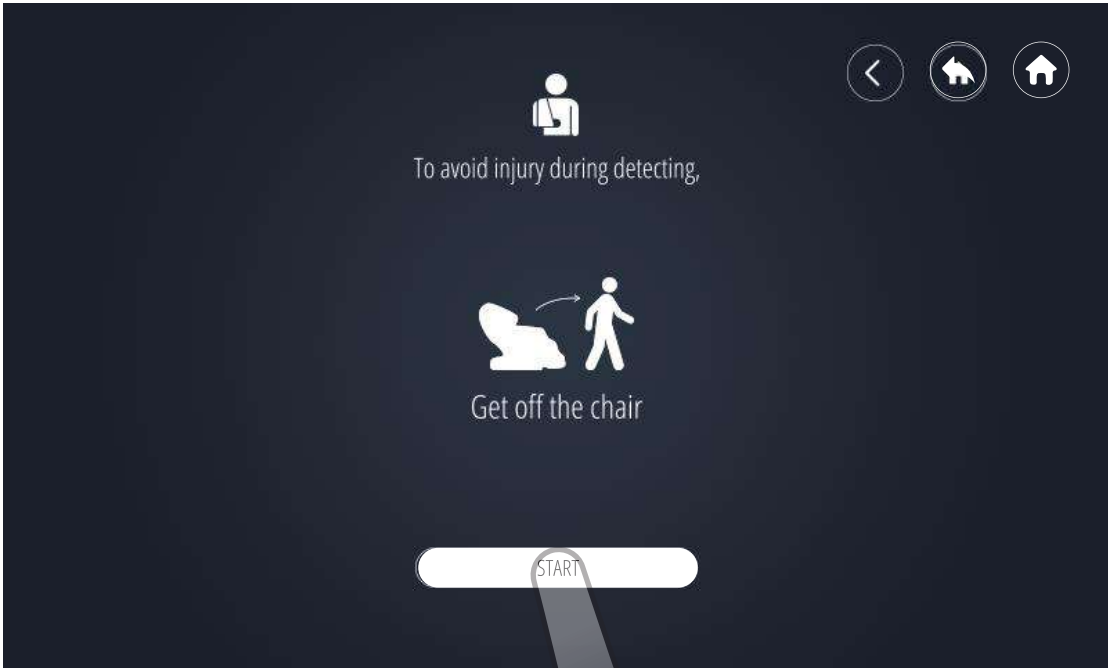

Choose "Start" button and make sure the chair is not occupied during chair detection

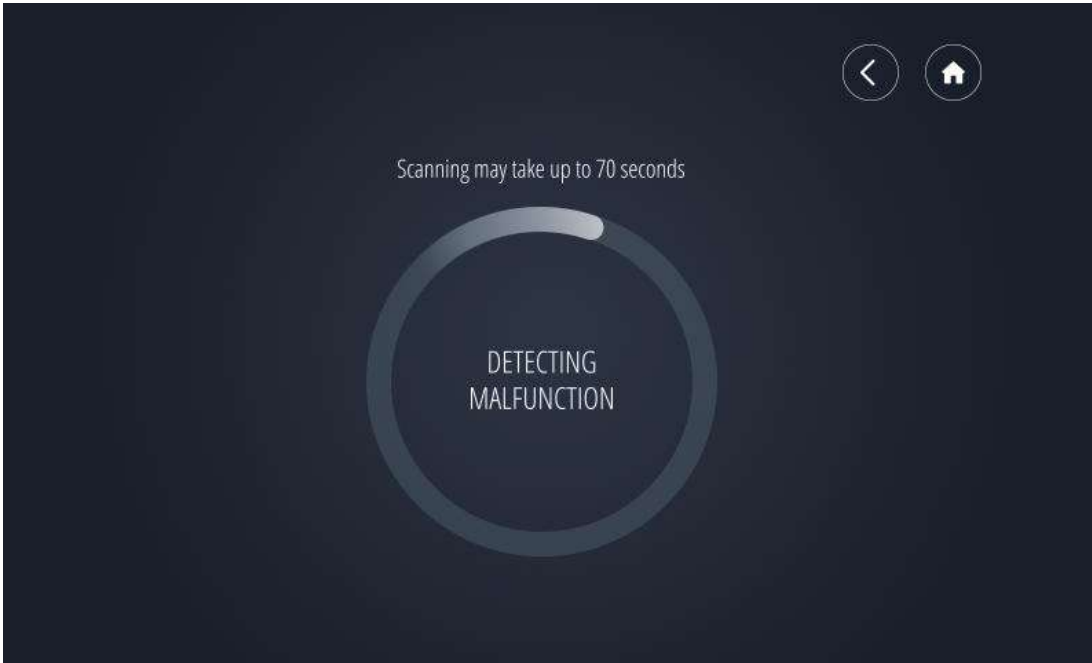

Your chair is detecting possible malfunctions, please wait for the detection result



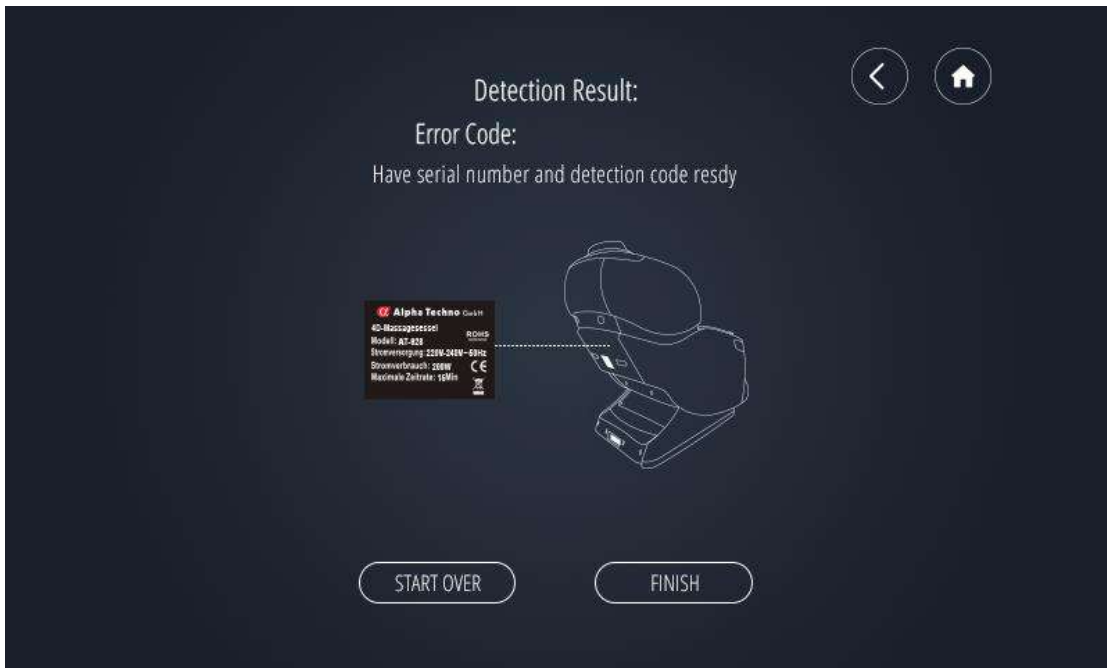

You can use your detection code when contacting the Alpha Techno customer team about your chair's problems

# SAFETY PRECAUTIONS

We're looking out for you.

## IMPORTANT SAFETY INSTRUCTIONS

When using the massage chair, basic precautions should always be followed, including the following:  
Read all instructions before using this massage chair.

**DANGER**--To reduce the risk of electric shock:

- Always unplug this massage chair from the electrical outlet immediately after using and before cleaning.
- Never use pins or other metallic fasteners with this appliance.
- Carefully examine the covering before each use. Call for service if the covering shows any sign of deterioration, such as blistering, peeling or cracking.
- Keep dry--Do not operate in a wet or moist condition.

**WARNING**--To reduce the risks of burns, fire, electric shock or injury to persons:

- Read all instructions before using.
- A massage chair should never be left unattended when plugged in. Unplug from the outlet when it is not in use and before putting on or taking off parts.
- Close supervision is necessary when this massage chair is used by or near children or disabled persons. Keep children away from reclining backrest and extended leg rest.
- Use this massage chair only for its intent use as described in this manual.
- Never operate this massage chair if it has a damaged cord or plug, if is not working properly, if it has been dropped or damaged, or dropped into water. Contact Customer Service Department.
- Keep the cord away from heated surfaces.
- Never operate the massage chair with the air openings blocked. Keep the air openings free of lint, hair and the like.
- Never drop or insert any object into any opening.
- Do not use outdoor.
- Do not operate where aerosol (spray) products are being used or where oxygen is being administered.
- To disconnect, turn all controls to the off position, then remove the plug from the outlet.
- Do not stand on or in the massage chair. Use only while seated.
- The product is not intended for use by children or persons with reduced physical, sensory or mental capabilities, or lack of experience and knowledge, unless they have been given supervision or instruction concerning use of the product by a person responsible for their safety.
- Children should be supervised to ensure that they do not play with the product.
- Temperatures sufficiently high to cause burns may occur regardless of the control setting. Do not use on an infant or invalid or on a sleeping or unconscious person. Check the skin in contact with the heated area of the appliance frequently to reduce the risk of blistering.
- Burns may result from improper use.
- Do not crush in order to avoid sharp folds.
- Keep children away from extended foot support (or other similar parts).
- DO NOT WET.
- DO NOT USE PINS.
- NEVER REMOVE COVER.
- Connect this appliance to a properly grounded outlet only. See Grounding Instructions.

## SAVE THESE INSTRUCTIONS

This massage chair is intended for household use only.

### 1. Usage Environment

- Do not use the massage chair in an excessively humid or dusty environment as this may result in malfunction or electric shock.
- Do not use the massage chair in a room with a temperature of 104°F or higher.
- Do not expose the massage chair to heaters, stoves or direct sunlight.
- Place and use the massage chair on an even, non-slip floor.
- The massage chair is designed for home use and not for commercial purposes.



#### Caution

- This massage chair is to be used indoors only.
- If you use the massage chair in a cold room, do not increase the room temperature abruptly. It is recommended that you increase the temperature gradually to a normal level.
- If the massage chair is stored in a cold place and is being brought into a warm environment, it is advisable to wait for one hour before use. This is because its performance may not be at optimum level, as there may be water droplets on the mechanical parts due to condensation. Using the massage chair under such conditions may result in malfunction.

### 2. Safety Precautions

- To ensure safe and correct use of the massage chair, do not operate it without reading this operation manual carefully.
- Do not use the massage chair when the upholstery or seat is removed. This may cause injury or malfunction.
- Do not use the massage chair in combination with other therapeutic equipment or electric blanket etc., as this may result in ineffectiveness or injury.
- Do not use the massage chair an hour before or after eating as this may have adverse effects on the user.
- Do not allow children or pets to play around the massage chair, e.g. behind the backrest, under the seat base or legrest of the massage chair. This may result in injury.
- Do not use the massage chair when your body is wet.
- Do not operate the massage chair with wet hands.
- It is not recommended to use the massage chair for more than 30 minutes.
- Do not perform continuous massage on the same spot of your body for more than 5 minutes at a time as this may result in excessive stimulation and may have adverse effects.
- Do not insert your hand or foot along the paths of the massage rollers during use as this may cause injury.
- Stop operation immediately if you feel any discomfort.
- This product is not intended for self-treatment of conditions that should be managed by a qualified health care provider.
- People on medication or with medical conditions, please consult your doctor before use. Please do not use the product if you are not feeling well.

### 3. People with Medical Conditions

Consult your doctor before use if you:

- are under medical rest as ordered by a doctor.
- have spinal disorders, an abnormal spinal condition or have suffered a spinal injury.
- have back problems.
- have diabetes, osteoporosis or sensory impairment.
- have joint dysfunction such as rheumatism, hammertoe or gout.
- have a pacemaker or other electronic medical devices.
- may be pregnant.
- have phlebitis or thrombosis.
- have an increased risk for blood clots.
- had recent surgery.
- Have surgical pins, screws, or anything mechanical in the legs, ankles or feet.



Caution

- This massage chair is not intended for use by children or persons with reduced physical, sensory or mental capabilities, or lack of experience and knowledge, unless they have been given supervision or instruction or instruction concerning use of the massage chair by a person responsible for their safety.
- Children should be supervised to ensure that they do not play with the massage chair.
- Avoid using the massage chair under the influence of alcohol.
- Do not apply massage rollers directly on the head, elbow or knee joints, torso or abdomen.
- If your legs or feet slip off the leg rest during massage, do not force them back in as this may result in injury.
- Remove the power plug from the electrical outlet immediately should liquid be accidentally spilled onto the massage chair. Do not use wet hands to connect or disconnect the power plug from the electrical outlet.
- Do not tamper with the power cord or use the massage with a damaged cord as this may result in malfunction and electric shock.

#### 4. Instances When the Massage Chair Should Not Be Used

In the following events, please switch off the main power switch immediately and disconnect the power cord from the electrical outlet:

- if liquid is accidentally spilled onto the massage chair. This may result in electric shock or malfunction.
- If the fabric of the backrest is torn and the internal components are exposed.
- If pain or discomfort is felt during massage, stop operation immediately and consult your doctor.
- If you detect any malfunction or any other abnormal condition during operation.
- If there is power failure. Injury may occur when power is restored unexpectedly.
- If there is lightning.

#### 5. Assembly and Repair of the Massage Chair

- Do not disassemble the backrest cover of the massage chair. Touching the internal components may result in malfunction or electrical shock.
- This massage chair must only be professionally serviced or repaired. Do not attempt to disassemble or repair the massage chair by yourself.

#### 6. Things to Be Noted About the Power Plug and Cord

- Check that the Alternating Current (AC) voltage corresponds with the specifications indicated for the massage chair.
- Do not connect or disconnect the power plug from the electrical outlet with wet hands. This may result in malfunction or electric shock.
- When disconnecting the power plug, pull it by holding the plug, not the cord.
- Although operation will be stopped automatically by the Auto-Timer function, always remember to switch off the main power after use.
- Do not place the power cord under the massage chair or any other heavy objects.
- Do not wind the power cord around the massage chair as this may damage the cord and result in a fire or electric shock.
- Do not operate the massage with a damaged cord or extension cord.
- Do not use the massage if the electrical outlet is loose.
- If the power cord is damaged, it should be replaced by a qualified technician.

# GROUNDING INSTRUCTIONS

This product must be grounded. If it should malfunction or break down, grounding provides a path of least resistance for the electric current to reduce the risk of electric shock. This product is equipped with a cord with an equipment-grounding conductor and a grounding plug. The plug must be plugged into an appropriate outlet that is properly installed and grounded in accordance with all local codes and ordinances.

**Danger-**Improper connection of the equipment-grounding conductor can result in a risk of electric shock. Check with a qualified electrician or service technician if you provided with the product-if it will not fit the outlet, have a proper outlet installed by a qualified electrician.

This product is for use on a nominal 120V circuit and has grounding plug that looks like that plug illustrated below. Make sure that the product is connected to an outlet having the same configuration as the plug. No adapter should be used with this product.

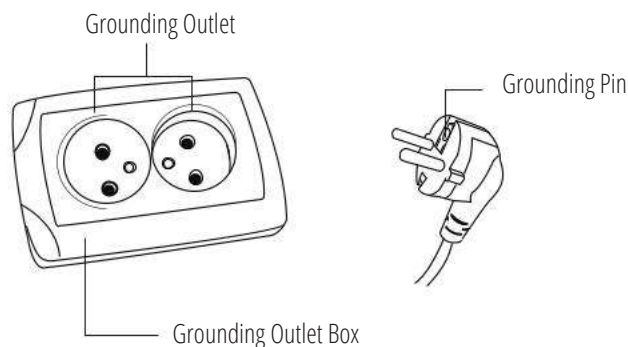

# TROUBLESHOOTING

This massage chair is controlled by a microcomputer and is thus susceptible to power surges of +10 to-15%. The following situations may arise in the event of a power surge:

Situation	Solution
The massage chair is connected to the power supply but is not functioning.	<ol style="list-style-type: none"><li>1. Check to see that the plug is properly connected and working</li><li>2. Ensure the massage chair switch is in the 'I' position</li></ol>
The remote control works but the massage chair is not functioning.	Possible overheating due to prolonged use. Turn off the power for at least 30 to 50 minutes.
Both the remote control and the massage chair are not functioning.	<ol style="list-style-type: none"><li>1. Ensure the chair is plugged into a working outlet</li><li>2. Turn the power OFF and ON again</li></ol>

If you continue to have problems, please read the warranty card and contact the Alpha service department.

# PRODUCT CARE AND STORAGE

## 1. Storing the Massage Chair

- Wipe off dust and dirt from the massage chair with a dry, soft, clean cloth after use.
- Keep the massage chair clean and away from places of high humidity.
- If the massage is not to be used for a long period of time, cover the massage chair with a dust cover and unplug its power plug from the electrical outlet.

### Caution

- Do not store the massage chair in direct sunlight or in places of high temperature. This may cause the color of the upholstery to fade.
- Do not allow the massage chair to remain in contact with vinyl or wallpaper for extended periods of time as this could lead to discoloration.

## 2. Cleaning the Massage Chair

- Before cleaning, ensure that the main power switch is off and the power plug is disconnected from the electrical outlet.
- Wipe off dust and dirt from the massage with a dry, soft, clean cloth after each use.
- This product can be cleaned thoroughly with a slightly damp cloth.
- Do not iron the upholstery.
- Do not wash the upholstery using a home washing machine as this may result in deterioration of the upholstery's quality.

### Caution

- Do not use abrasive cleaning agents like benzene or thinner to clean the massage chair. This may cause the upholstery to fade.

## 3. Cleaning the Controller

- Use only a clean, dry cloth to clean the controller.

### Caution

- Do not use a wet cloth to clean the controller. This may result in malfunction.

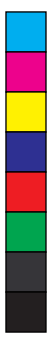

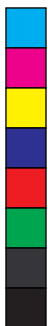



**Enjoy your new massage chair**



**Alpha Techno GmbH**  
Ernst-Bauer-Str.1  
97941 Tauberbischofsheim  
Tel.: 09341 / 9285-0  
Fax: 09341 / 9285-28  
Email: [Info@Alpha-Techno.com](mailto:Info@Alpha-Techno.com)  
Germany

