



User Manual | AT-6602

Page 1:

Hello.

Congratulations on purchasing your new Relax Massage- chairs.

At Alpha Techno we understand that every body is different and have carefully designed your massage chair with that in mind. But enough about us, this is about you. Learning how to use your new chair is simple(we designed it that way).

So let's get started.

Page 2

-Thank for your purchase of this product. Before using, please read this USER MANUAL carefully, and pay special attention to the safety precaution to ensure proper operation and use.

-Please keep this USER MANUAL properly for further reference.

Safety Precautions	01
Product Structure.....	02
Shortcut Buttons Description.....	03
LCD Screen Operation Guide.....	04
Play Music.....	05
Installation.....	
How to place the chair.....	
Steps for Usage.....	
Maintenance.....	
Specification and Dimension.....	
Troubleshooting.....	
Contact Us.....	

Safety Precautions

- The plug of the massage chair must be fully inserted into an appropriate outlet. Improper connection of the equipment-grounding conductor can result in the risk of electric shock.
- Check with a qualified electrician and service personnel if you are in doubt as to whether the product is properly grounded. Please do not modify the product's accompanying plug. If the outlet is not suitable, be sure to have a proper outlet installed by a qualified electrician.
- When using the massage chair, basic precautions should always be followed to reduce the risk of electric shock, burns, fire, or injury.

Read the following details before use:

- ① Be sure to insert the massage chair plug into the proper electrical outlet.
- ② Make sure that the power plug is securely inserted into the proper electrical outlet to reduce the risk of short-circuiting and fire.
- ③ Always unplug the massage chair from the electrical outlet immediately after use and before cleaning.
- ④ Please do not use the massage chair in places where the humidity is high.
- ⑤ Please do not use the massage chair outdoors and avoid places with direct sunlight.

⑥ If the power goes off during use, be sure to turn the power switch to the "O" position and pull the power plug out from the socket to prevent any damage at the time when the power comes back.

⑦ Never operate the massage chair if the power cord is wet or damaged.

⑧ Never plug/unplug the power cord from the socket with wet hands.

⑨ Close and continuous supervision is necessary when this appliance is used by or near children, invalids or disabled persons.

⑩ Use this appliance only as described in this user manual.

11 Please do not use any attachments other than those recommended by our company.

12 Please do not stand, sit or jump in the footrest when the massage chair is in use. This may result in an accident or injury.

13 Please do not attempt to stand on the backrest and armrest . This may result in an accident or injury.

14 Be careful not to fall asleep during the massage.

15 Always keep the massage chair clean and never insert any object into the gaps on and around the massage chair.

16 Please do not remove the massage chair by pulling out the power supply cord.

17 Be sure to check that there is no one (children in particular),

pets or obstacles under the massage chair prior to lowering the footrest /backrest.

18 Always check whether the surface of the massage chair is torn or ripped before use. If you find any unfamiliar tears in any area of the cloth in the backrest, please do not use the massage chair. Kindly contact the agency immediately for repairs.

19 This appliance is designed for household use only.

20 For people suffering from illnesses, please consult your doctor on whether you can use the massage chair if in doubt.

21 The following persons are requested to consult a doctor prior to use to reduce the risk of feeling sick or suffering from an injury:

- People who have a malignant tumor;
- People who suffer from heart disease;
- People who are experiencing pregnancy, menstruation and puerperal;
- People who require complete rest;
- People who are under medical treatment;
- People who suffer from back problems or whose backbone is abnormal or bent.

22 If you experience pain during use, stop the massage chair immediately. If any injuries happen, consult a doctor immediately.

23 Never massage swollen or inflamed parts of the body.

24 The product is a non-professional appliance designed to provide a comfortable massage. Please do not use this product as a substitute for medical treatment.

25 Do not use this massage chair for more than 30 minutes at one time and kindly limit the massage to a concentrated area for not more than 15 minutes. Over-massaging can result in overheating, and thus reducing the product's lifespan.

26 Please do not operate where aerosol (spray) products are used or where oxygen is being administered.

27 The massage chair is not suitable for children aged 12 years old and below.

28 If the supply is damaged , it must be replaced by a special cord or assembly available from the manufacturer or its service agent.

29 This appliance is not intended for use by persons (including children) with reduced physical, sensory or mental capabilities, or lack of experience and knowledge, unless they have been given supervision or instruction concerning the use of the appliance by a person responsible for their safety.

30 As a safety precaution , the Motor will stop working automatically (for protection) if apply too strong external force during use. Once appear above, switch OFF power , and switch ON again after 10 seconds . Please pay attention to this, especially for people whose

weight is over 100KG.

Product Structure

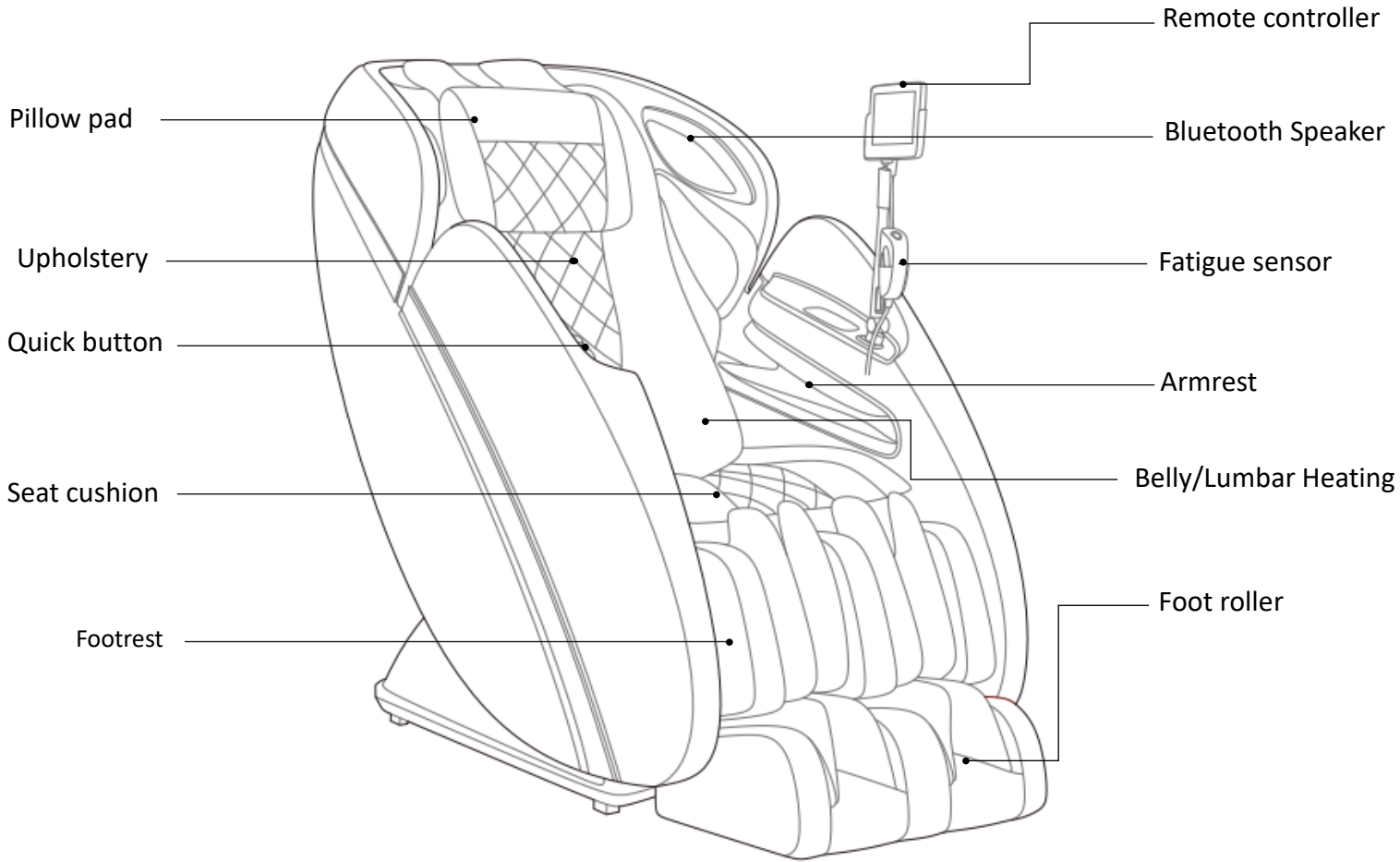

Quick button description

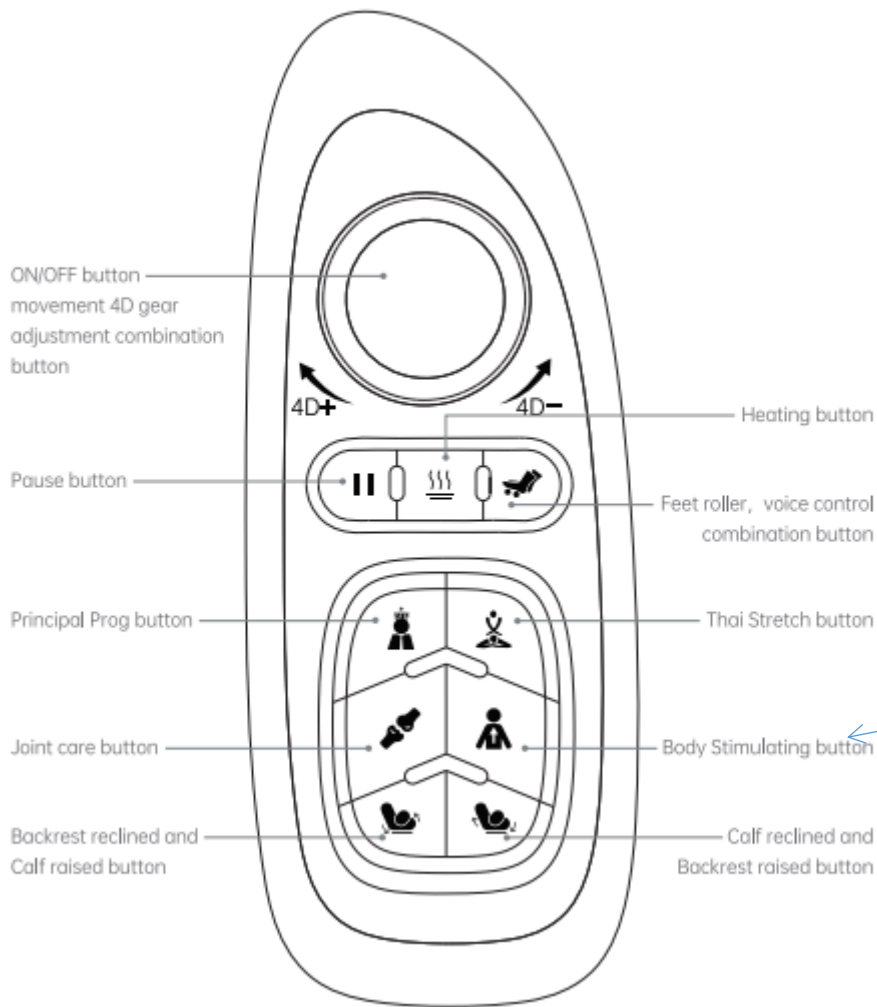

文字内容改成
Elixir of youth



ON/OFF, movement 4D gear adjustment combination Button

- ON/OFF function: In the off state, long press this button to turn on the massage chair;press this button again to turn off the massage chair and return to its original position
- Movement 4D gear adjustment: Clockwise rotation increases robots hands rollers' massage intensity; counterclockwise rotation decreases its intensity



Pause Button

Press this button to stop the massage chair function; press this button again to release the pause.



Heating Function Button

Press this button to turn on the lumbar and belly heating function, and press again to turn on knee heating function, and press the 3rd time to turn off heating function. This function could offer you a comprehensive warm experience.



Feet Roller, Voice Control Combination Button

- Foot roller function: Short press this button to turn on the foot roller function; short press again to turn off it.
- Voice control function: Turn on the power, long press this button for 5 seconds to turn on the voice control function, then you can control the massage chair by voice command.
- Long press this button for 5 seconds again to turn off the voice control the function.



Principal Prog Button

Press this button once, the chair will start “Principal Prog” function. This program mainly aims at the whole body massage.



Thai Stretch Function Button

Press this button once, the chair will start "Thai Stretch" massage. This massage mode is inspired by the Thai massage method, which aims at strong kneading and stretching for leg and lumbar, etc.



Joint Care Function Button

Press this button once, the chair will start the "Joint Care" function. This program mainly aims at the old and the athletes. And this program combines with airbag massage, providing smooth massage to the legs, feet, arms, and shoulders.



Body Stimulating Function Button

Press this button once, the chair will start “Body Stimulating” function. This massage is mainly at kneading the whole body, helping you to relax your muscles and enhance the body flexibility.



Backrest reclined and Calf raised Button

Short press this button to recline the backrest and raise the calf. Press it again to stop the action and confirm the selected position. Long press this button to raise the calf independently, and release this button when it is adjusted to a suitable position to stay.



Calf reclined and Backrest raised Button

Short press this button to raise the backrest and recline the calf. Press it again to stop the action and confirm the selected position. Long press this button to recline the calf independently, and release this button when it is adjusted to a suitable position to stay.

LCD Screen Operation Guide

ON/OFF

Connect to the power supply, and turn the switch to the "I" position, the chair is now in idle mode. Press the ON/OFF button at the top edge of the controller for 3 seconds, then you will see the boot interface.

Note: If you press the ON /OFF button again for 3 seconds while the massage chair is operating, all massage functions will stop and the massage chair will return to its original position.

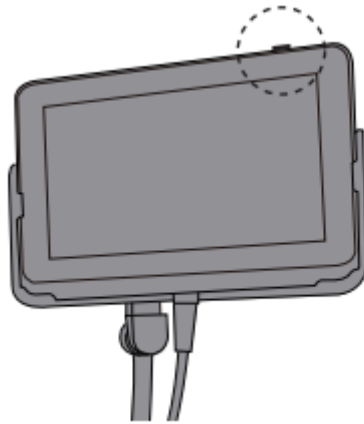

HOME PAGE

You can find path to any function on this page.



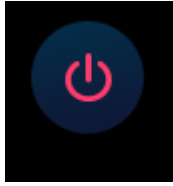

OFF button

Press this button to turn off the massage chair.

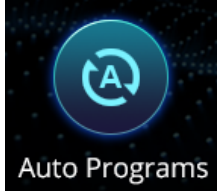

Auto message program function

After choosing one of twenty-seven auto massage programs, the massage chair will auto check the height of the shoulders and the body curve to achieve a more effective massage. You can also manually adjust the massage height in the test finished confirmation interface according to need. There are 5 big auto programs which are Exclusive, Theme, Act, My day, Origin. During all the auto massage programs, you can start or close heating or feet rollers as you want. And also you can start or close the Bluetooth, LED light, which will not influence your massage enjoyment.

- "Exclusive" auto program includes 4 specific auto programs: Principal Prog., Stretching, Joint care, Cervical. Touch any button to enjoy "Exclusive" massage.

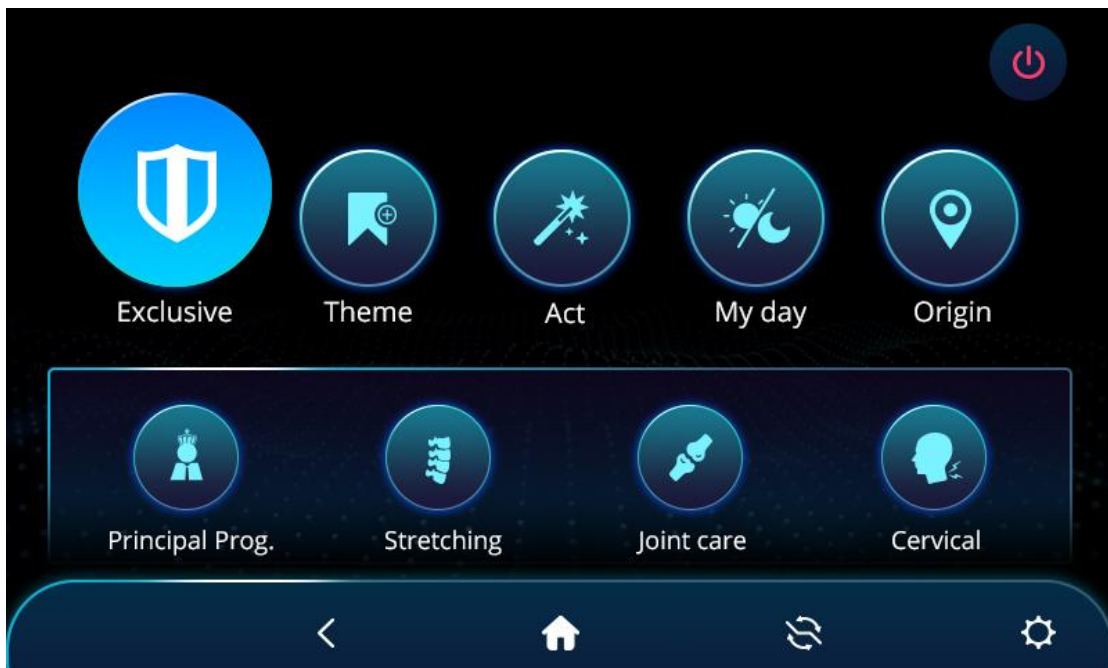

- "Theme" auto program consists of 6 auto modes: After Work, Elixir of youth, Meditation, Athlete, Relaxation, Freshness. You can touch any one of 6 auto mode buttons to start the "Theme" massage.

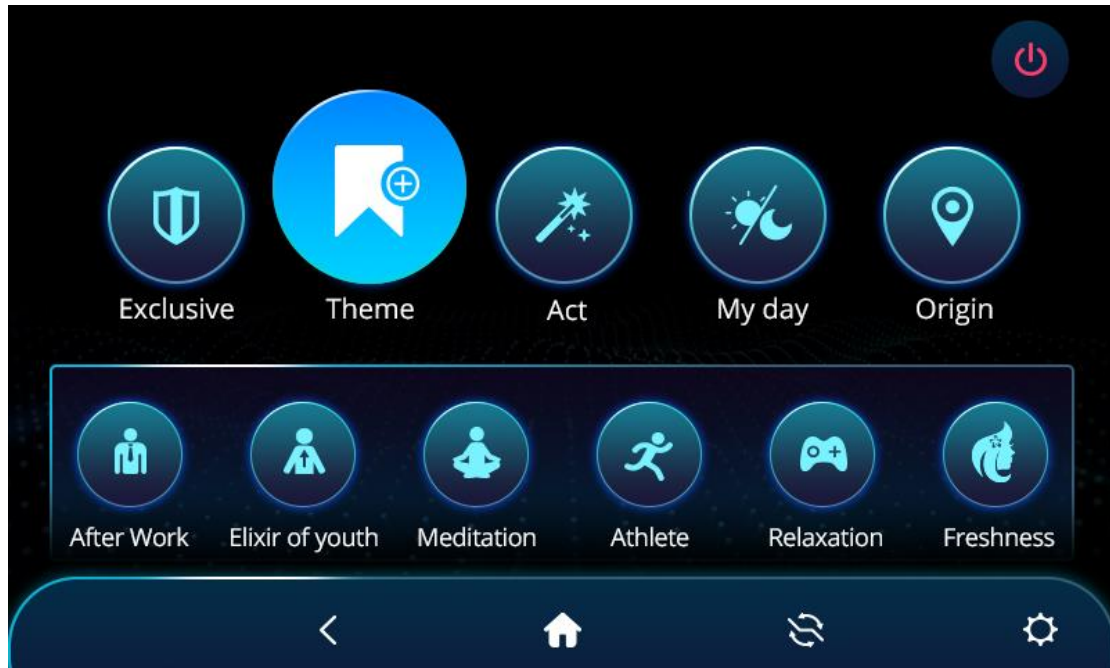

- "Act" auto program includes 6 auto programs which are Reflex zone, Recovery, Buttock, Spirit, Muscular, Digestion, Touch any one of 6 buttons to start the massage.

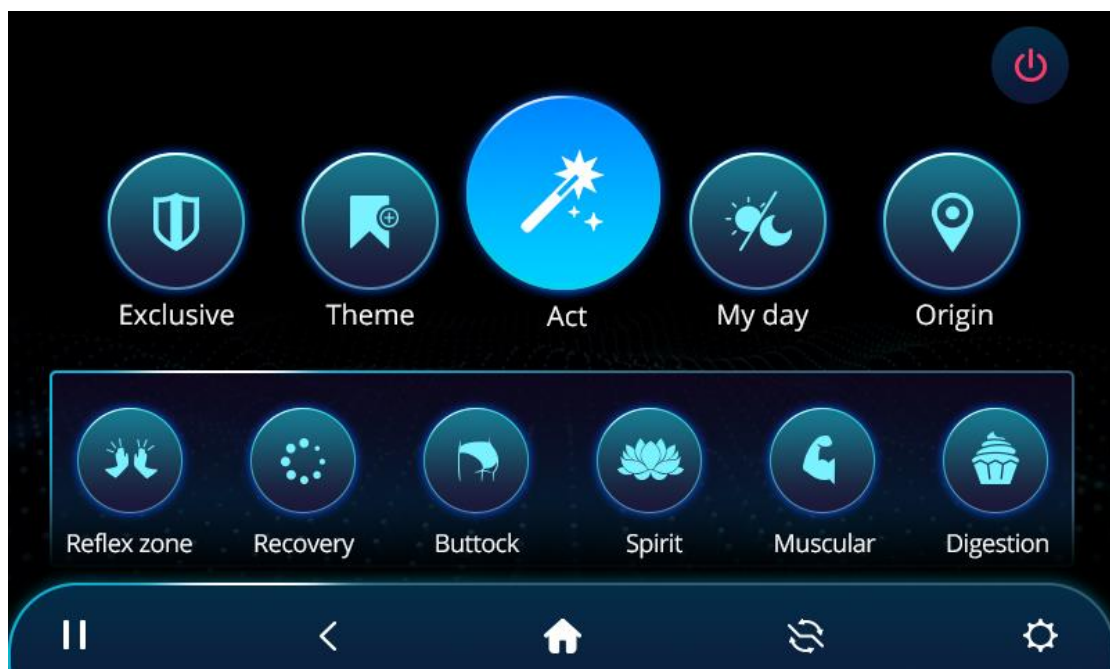

- "My day" auto program consists of 3 auto programs, they are Wake up, Magical day, Sweet night, Touch anyone of 3 buttons to start the massage.

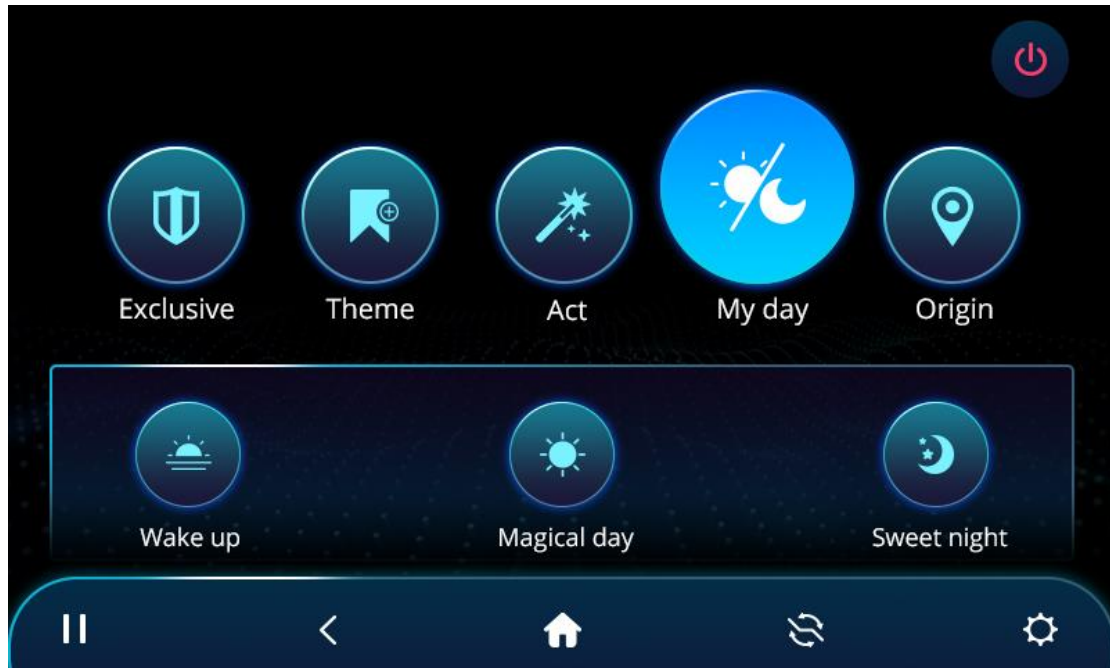

- "Origin" auto program includes 3 specific auto modes, which are Balinese, Chinese, Thai. Touch anyone of 3 buttons to start the massage.

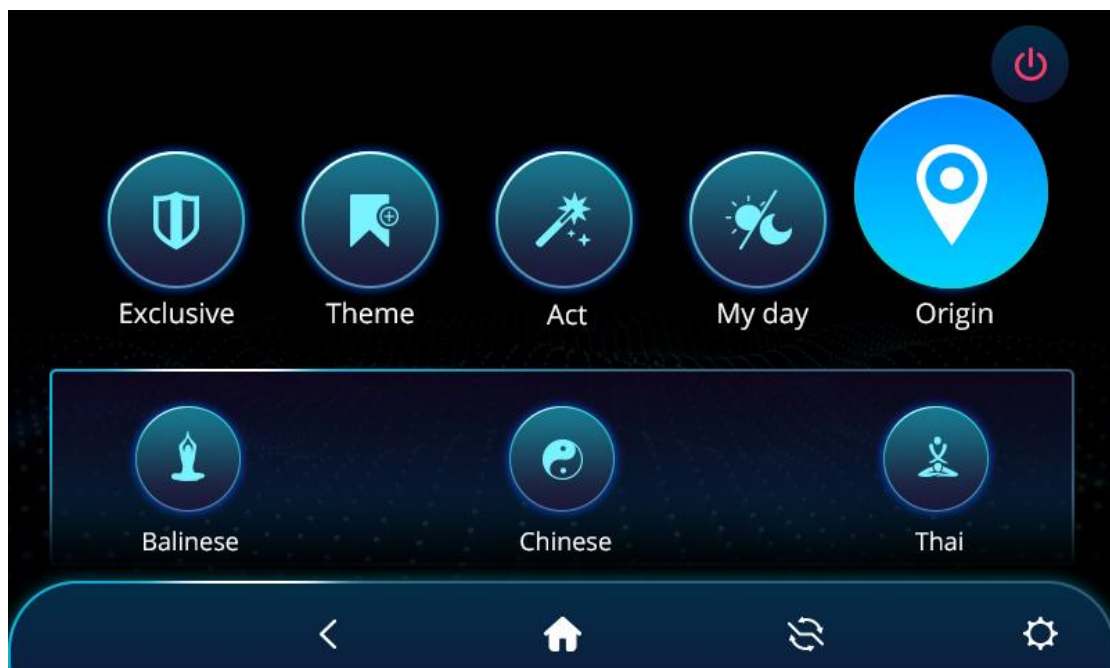

SHOULDER DETECTION

"▲ button" Adjust the position up manually

"▼ button" Adjust the position down manually.



After the adjustment meet the your need, press this button () to complete.



A.I Care

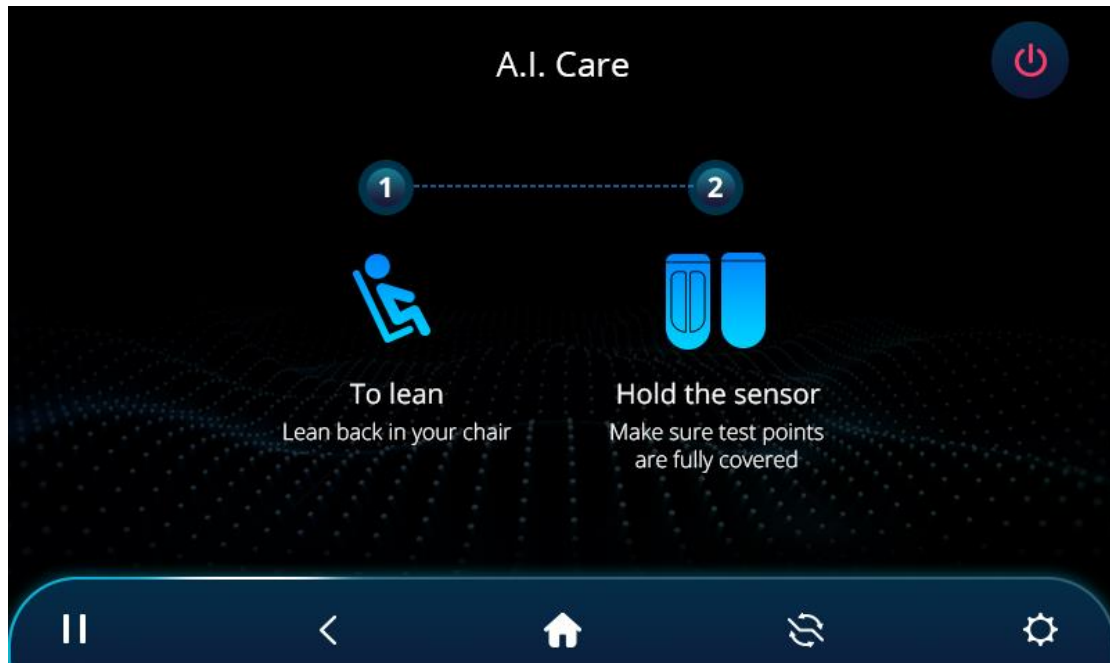

Keep the palm of your hand on the sensor until the detection is completed, the body chart will display your pain points. Then the system will recommend special massage programs accordingly.

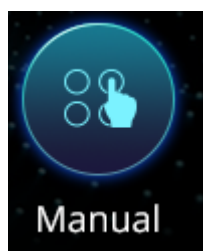
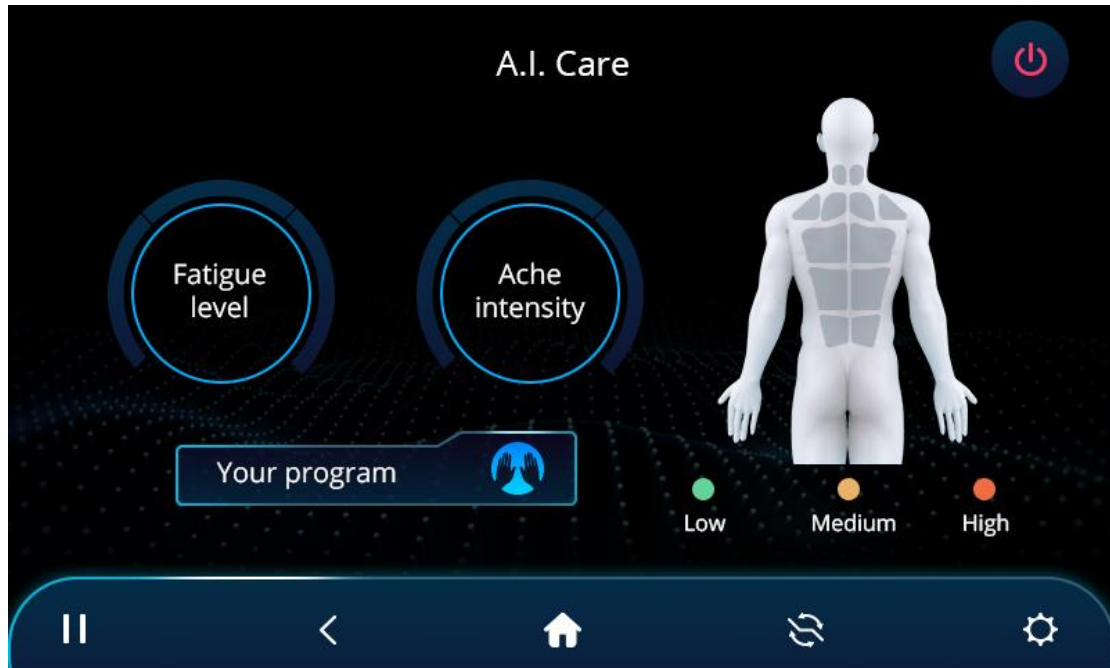



Manual

Manual program

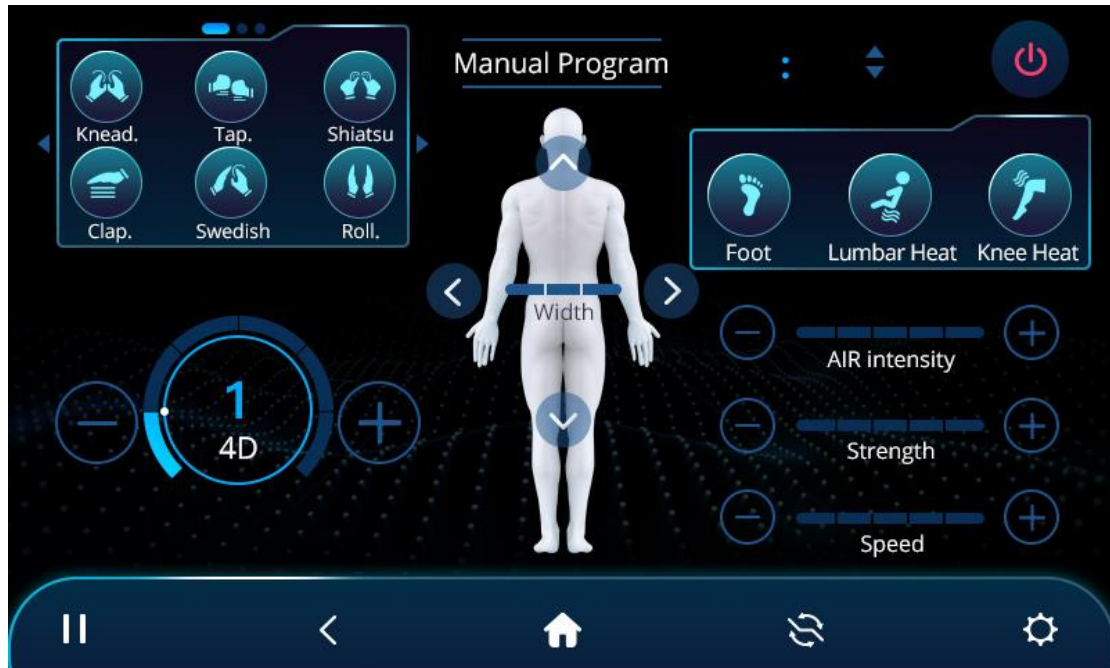

- On this page, there are 13 manual massage techniques which are Kneading 1, Kneading2, Tapping1, Tapping2, Shiatsu1, Shiatsu2, Clapping1, Clapping2, Swedish1, Swedish2, Rolling, muscle relaxing1, muscle relaxing2.
- Touch each button once to select mode 1, and again to select mode 2, except the Rolling function. Rolling function only has 1 mode.
- Adjust the 4D level by pressing the "-" and "+" at 4D part, and adjust the strength and speed of the massage robot by pressing the "and"" at Strength and Speed part.
- Adjust the width of the massage robot hand rollers by pressing  and . (Please note: Width cannot be adjusted when it is in Kneading and Swedish massage method.)

The massage time can be changed by touching button  you can change the time from the 15min->20min->25min-> 30min ->5min->10min and then 15min in sequence.

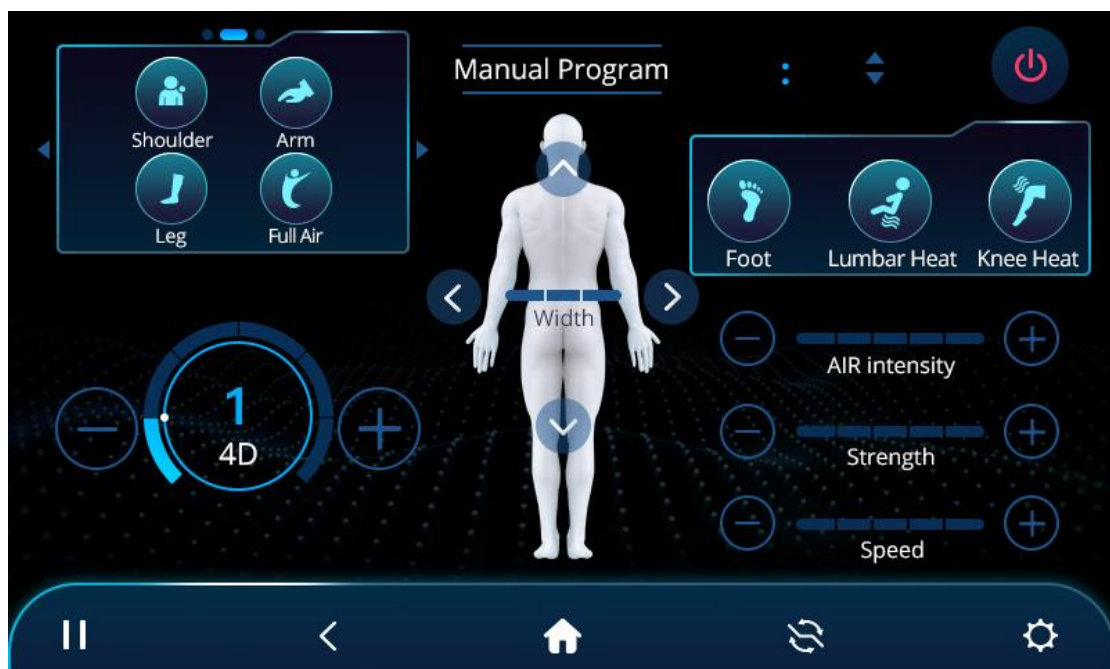

- Swipe the above page to the left, there are "Shoulder", "Arm", "Leg" and "Full Air" buttons. Touch each button to start the specific airbag massage. The airbag massage intensity can be adjusted by pressing the "-" and "+" at air intensity part, 5 levels of adjustable intensity can be chosen.



- Swipe the above page to the left, there are "Spot", "Partia", "Foot", and "Heat" buttons. In manual mode, press the Spot button to activate a fixed point massage as required position. And then long press the up  button and down  to change the point you need. Pressing the partial button to activate partial massage at a distance of approximately 8cm.

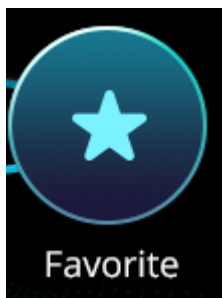
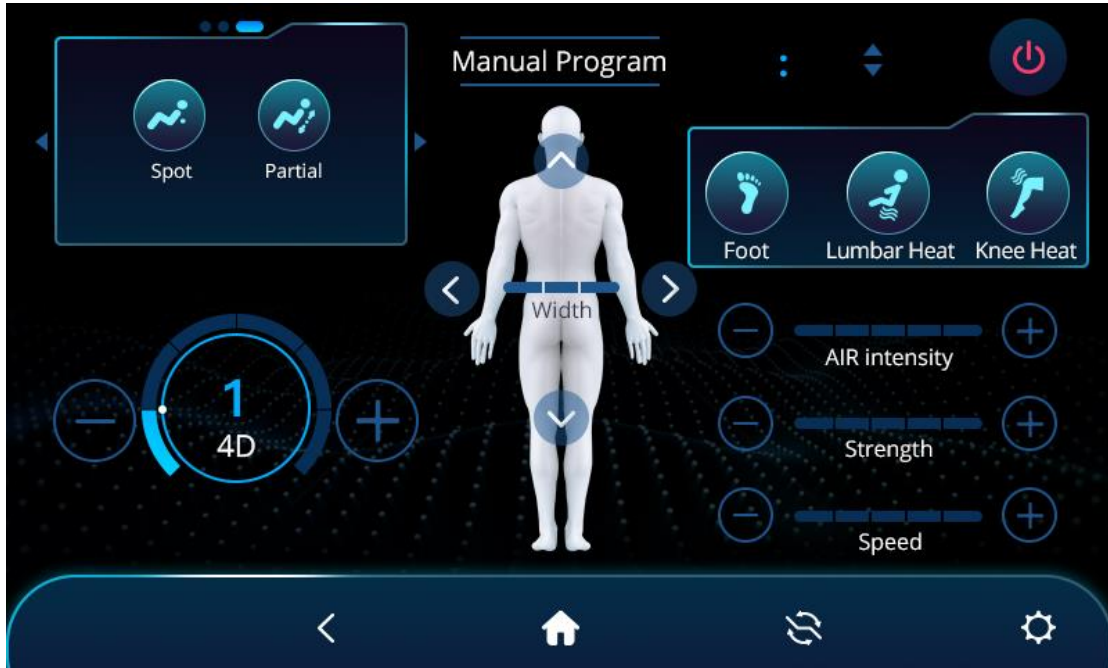

Favorite

Press this button on the HOME page. Then you can step into the following page. You can select



your favorite automatic program and press button (Favorite) on the top of every auto program page to save it. Then you can find all your favorite auto programs on the following page. If you don't like some selected programs, long press the icon until having a "x" on its right top, and then press the "x" to delete the selected program.

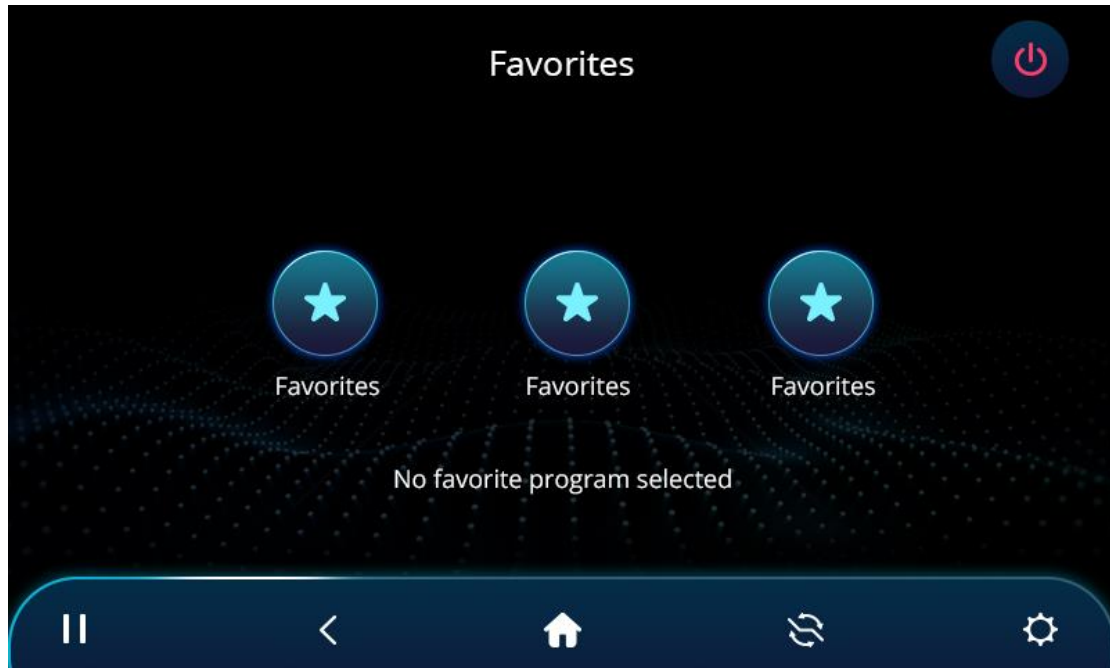

Mental Relax

Press this button on the HOME page to step into the following page. There are 5 big mental relax music situation which are Weather, Outdoors ,Combined Tone, Animal ,Metropolis. When any one of the 25 white noises is selected, the music stored in the massage chair will be played.

On this page, weather mental relax includes 5 mental relax which are Downpour, Eaves Rain, Thunder Rain, Fluffy snow, Howling Wind.

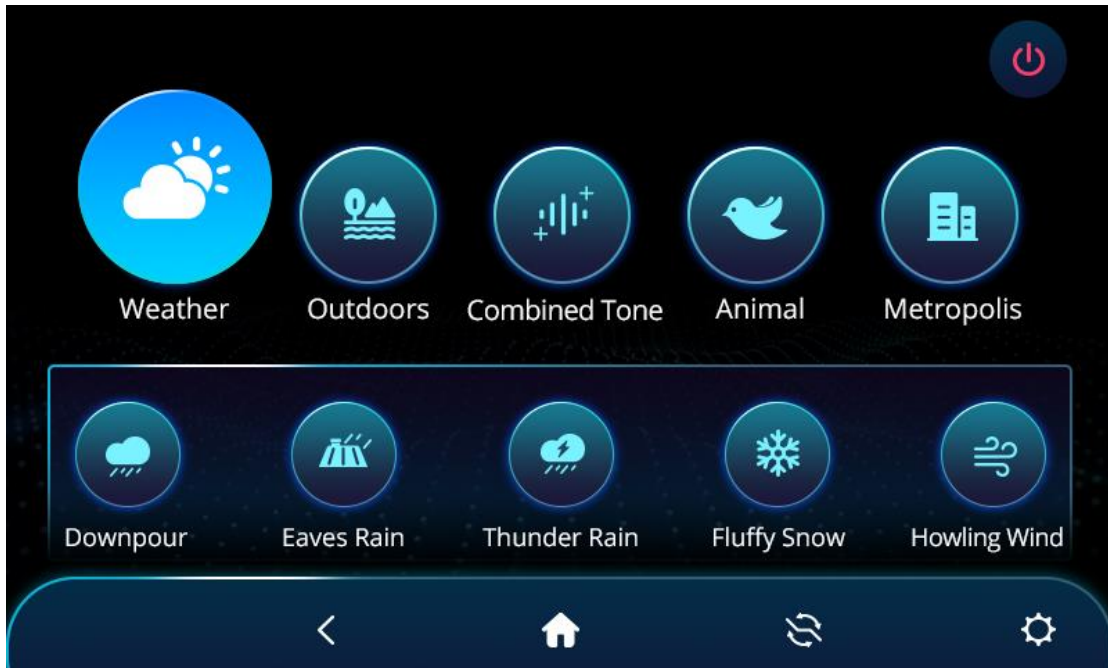

On this page, Outdoors mental relax includes 5 mental relax which are Leaves Twirled, tidal Waves, Flowing spring, Flaming bonfire, Magpies song.

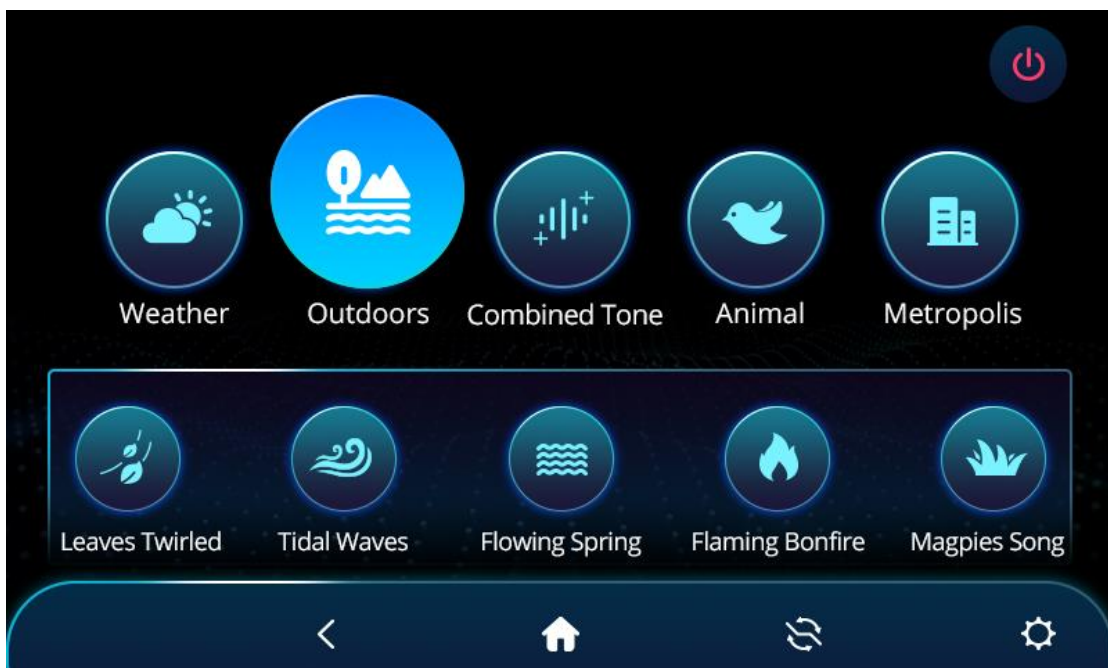

On this page, Combined Tone mental relax includes 5 mental relax which are Refresh, Wind Chime, Typewriter, Rain Ticktock, Chalk Writing.

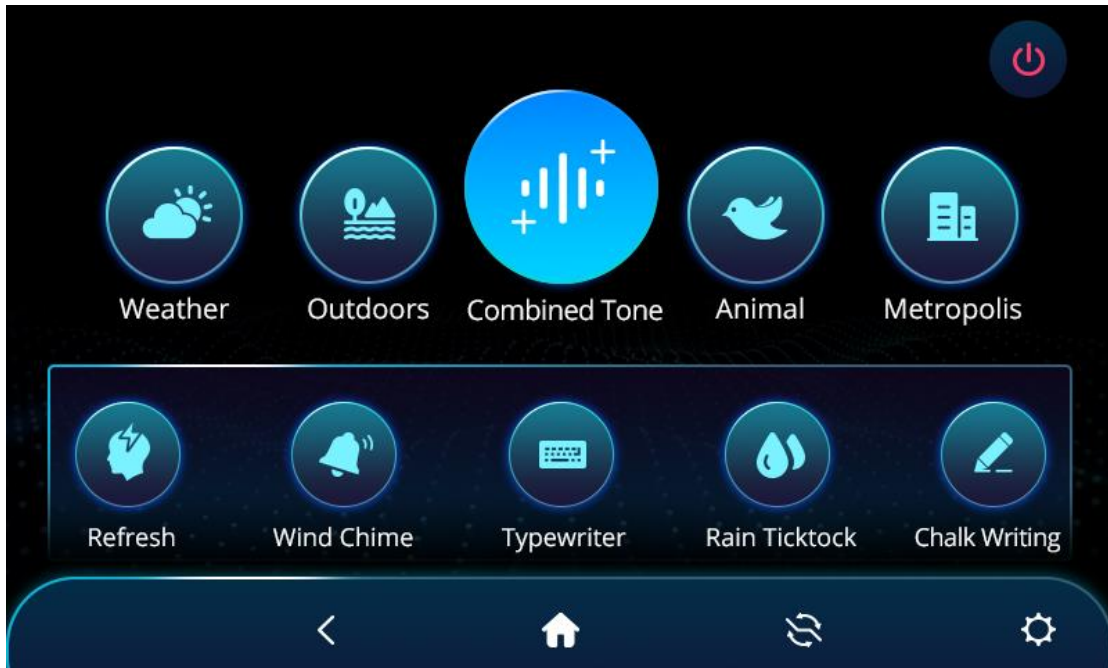

On this page, Animal mental relax includes 5 mental relax which are Tweetie lark, Woodpecker, Cheerful seabirds, spring Breeze, Baby Giggle.

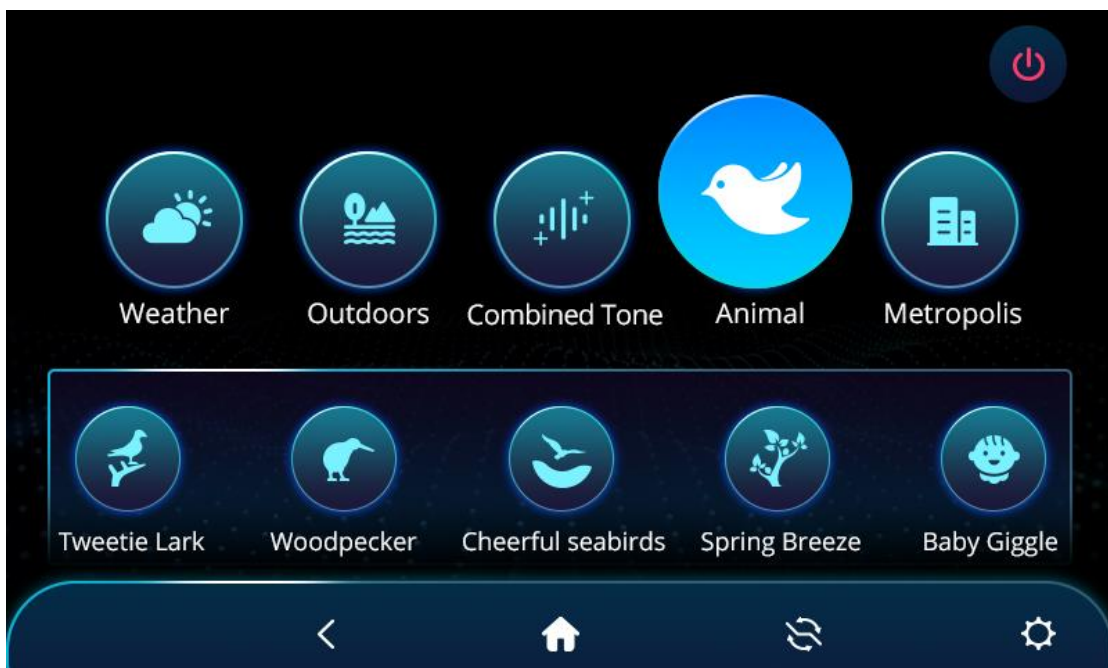

On this page, Metropolis mental relax includes 5 mental relax which are Space Travel, Chopping , Bowling, Urban Freestyle, Metro Platform.

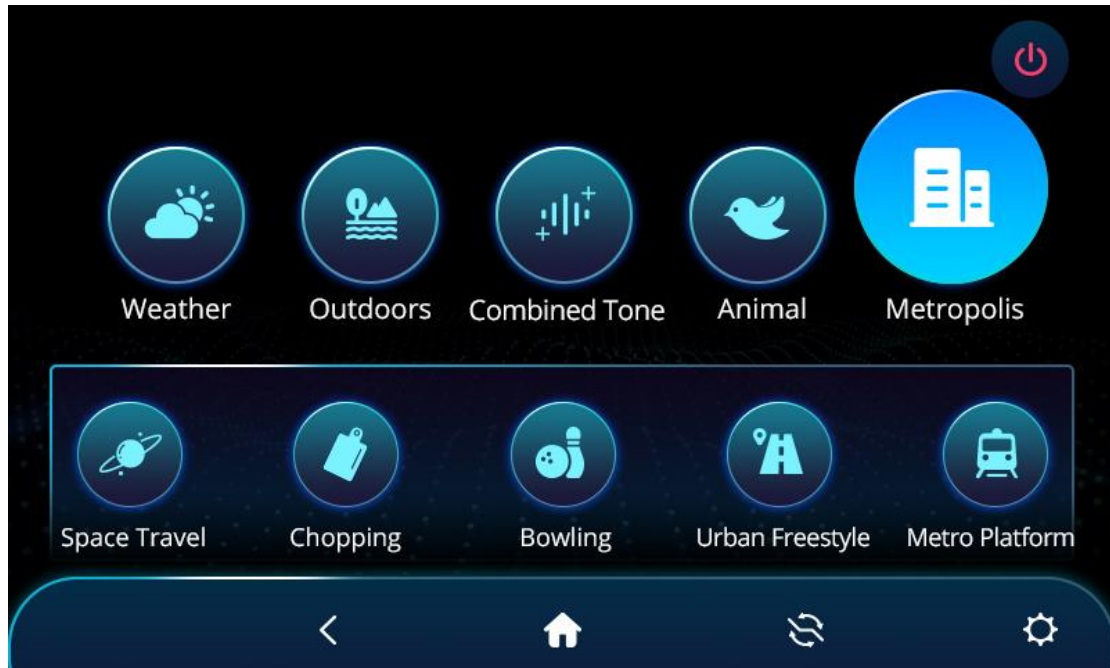

Position adjustment

By pressing the arrow label on the massage chair , the angle adjustment of the backrest and footrest can be realized.



Zero Gravity

Zero Gravity

Press this button to activate the Zero-G1 function, press the button again to activate Zero-G2 function, press again to return to close Zero-G function.

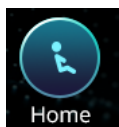

Home

Home

Touch this button to return the chair to its original position.

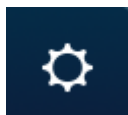
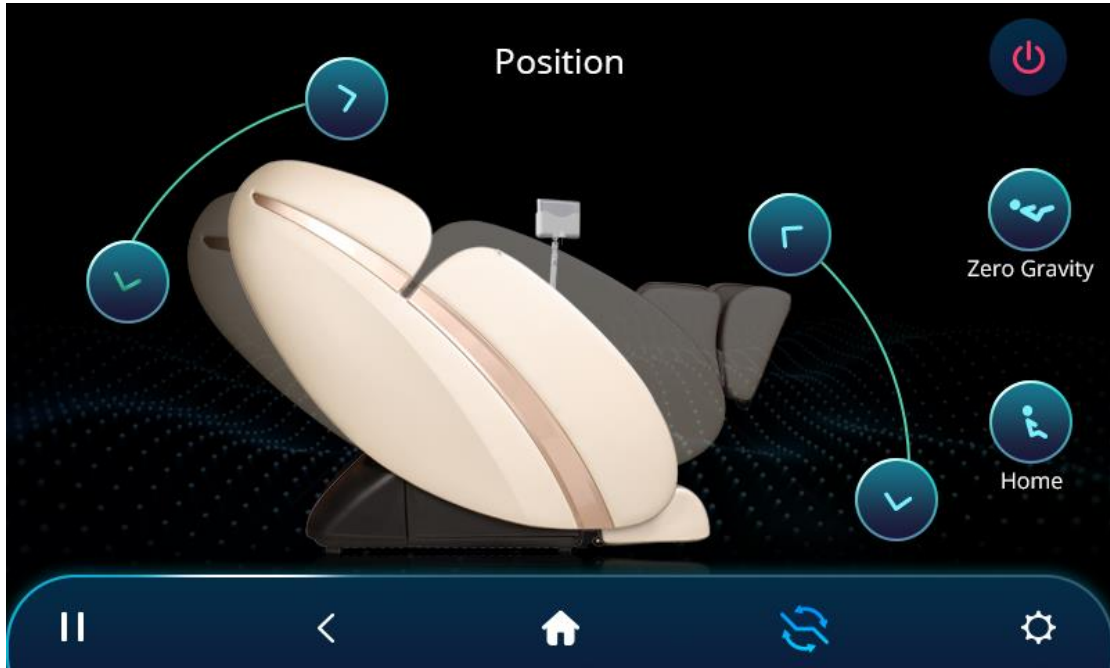

Settings

This page includes Language, Touch volume, stress-relief music, Screen sleep, Screen brightness and service center. You can change the touch volume, the volume of mental relax music, how long the screen sleep and the brightness of the screen on this page.

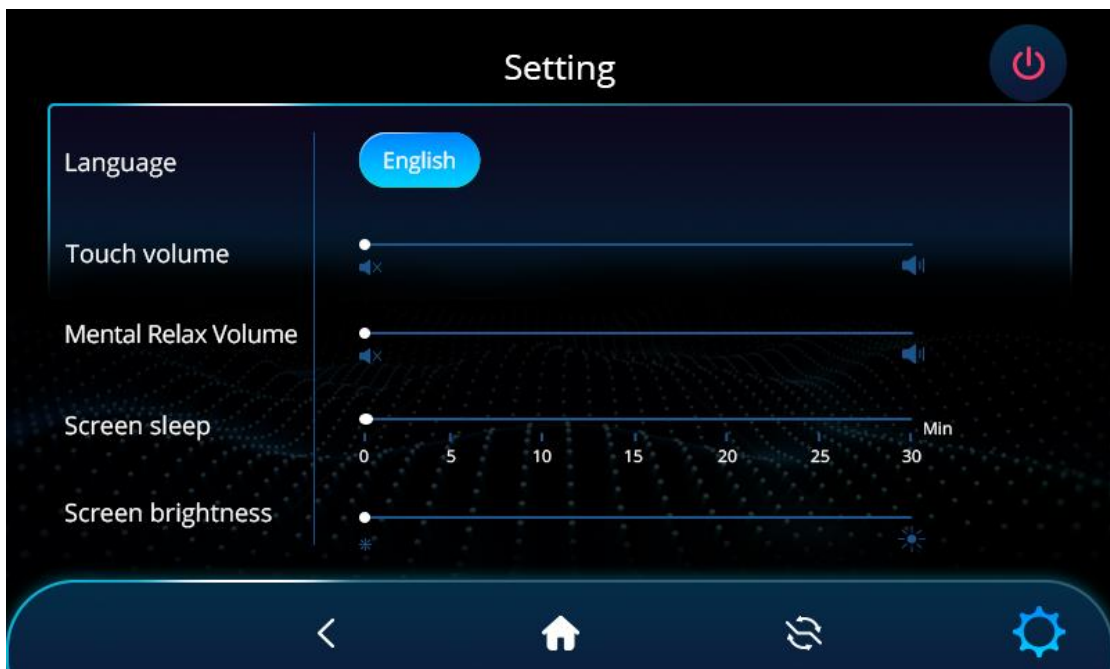

Installation

Install the footrest

1. Connect the calf tracheal joint K1 to the main body tracheal joint K2 (as shown in picture2).
2. Connect the electrical connectors (L1、 L2, M1、 M2), please pay attention to distinguish the number of needles and arrows (as shown in picture 3).
3. Put the calf ear seat N1 into the corresponding pin N2 on the main body (as shown in picture4please pay attention to the longer pin end first).
4. Insert the DK blocking card (two in total) into the pin shaft slot corresponding to the pin shaft(as shown in picture 5)

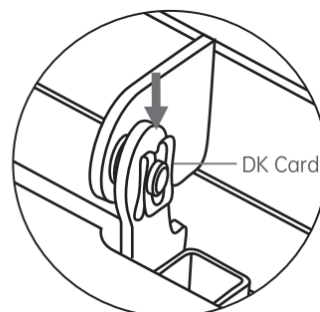
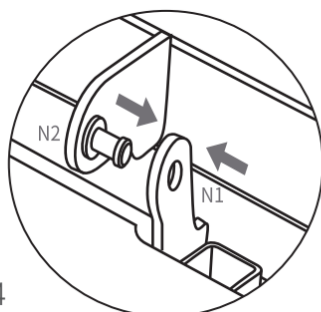
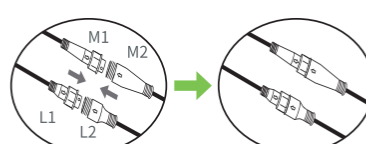
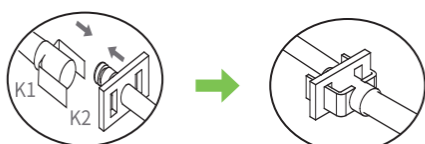
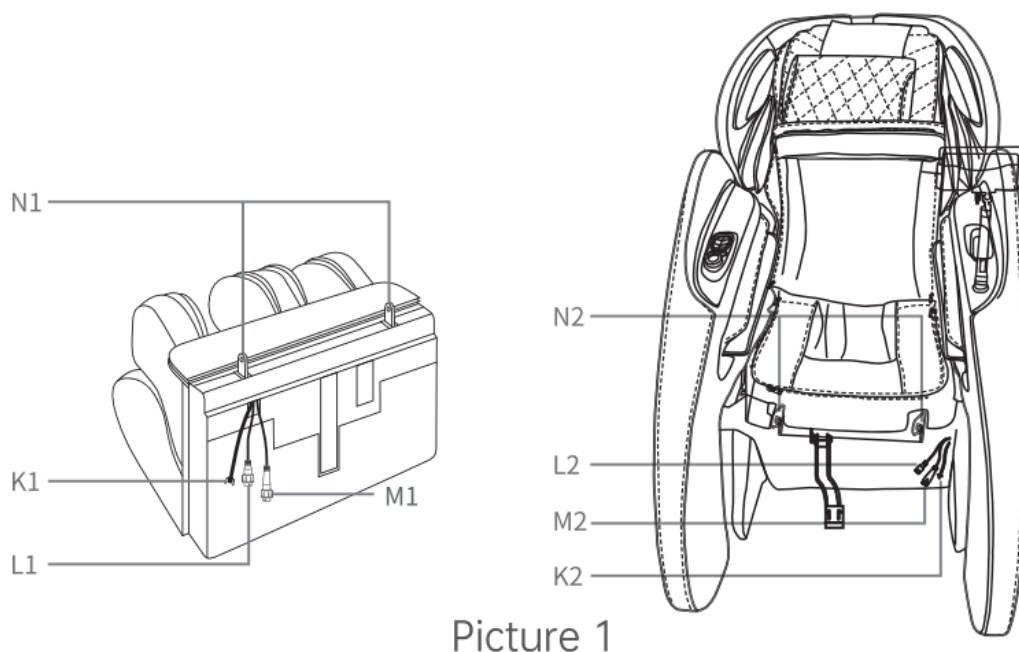

Operation Guide (Picture 3)

Please confirm the color of the terminal before installation, make

sure the color is consistent and adjust the direction of the terminal before connection.

1. Confirm the color of the terminal: red to red, black to black;
2. Adjust the direction of the terminal (white dot to white dot), and then plug it in firmly (see gray arrow guide);
3. Finally screw it in.



Smooth the backrest pad

Connect the 4 zippers of the backrest pad to the seat and footrest respectively to complete the installation.

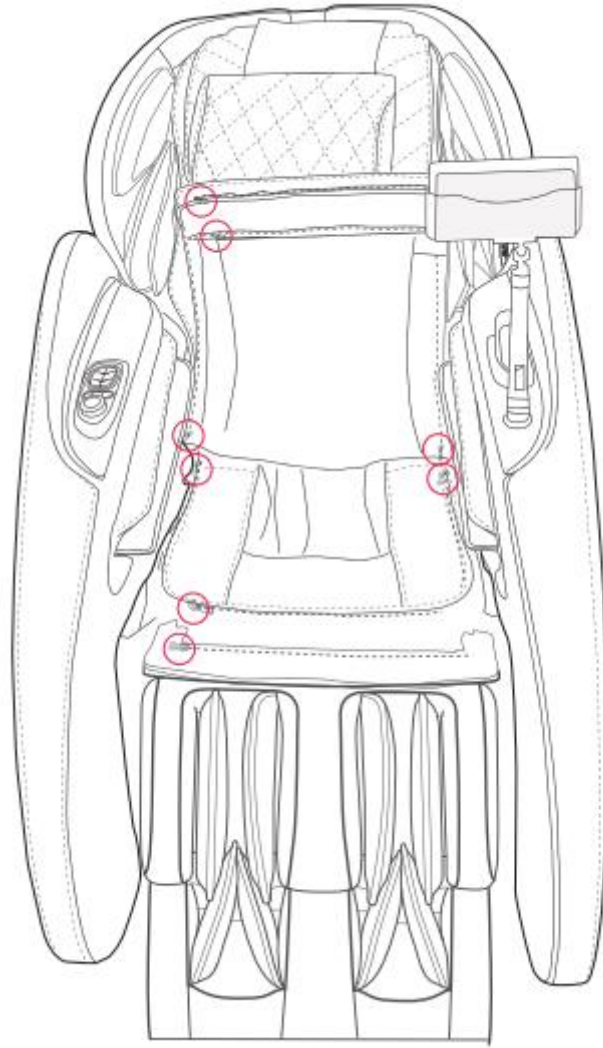

How to place the chair

Installation position

- Ensure there's enough space to recline.

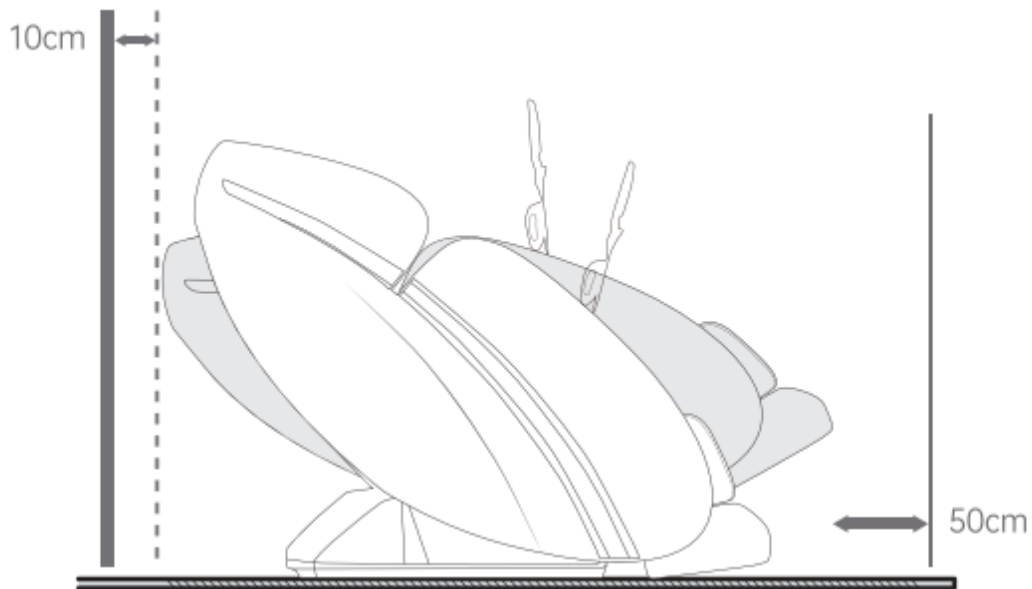

- Safe distance around massage chair. Please place the product in a place with sufficient space. The installation location must be at least 10 cm away from the back to the wall. When the product is placed, the distance between the power socket and the power switch should not be more than 1.5 meters.
- Please do not expose the massage chair directly to sunlight or high temperatures, such as in front of heating sources, because this can cause discoloration or hardening of the synthetic leather.
- Place a mat under the massage chair before moving to protect the floor from scratches.

Moving the chair

- A. Lift up the footrest.
- B. Recline the chair to approximately 45 degrees.

Caution:

Before moving the chair, adjust the footrest back to its original position.

Please do not move the massage chair when there is someone seated on it

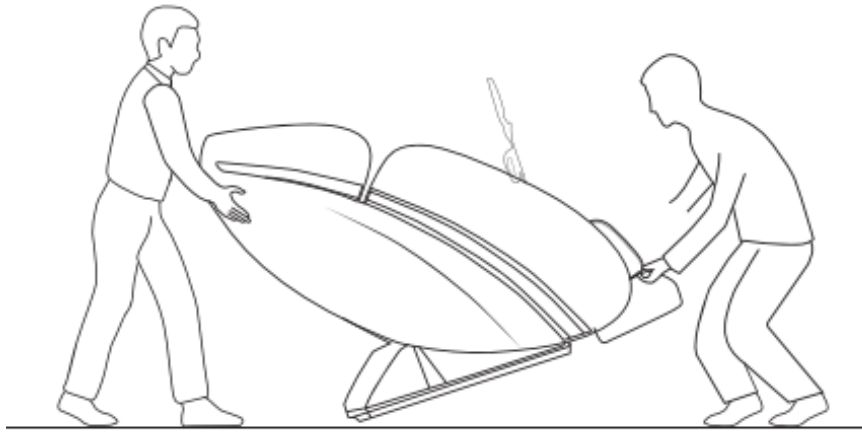

Steps for usage

1. Check with your surrounding to make sure there are no people, pets, or other objects around the chair.
2. To have a better back scanning, please remove the pillow on back before scanning.

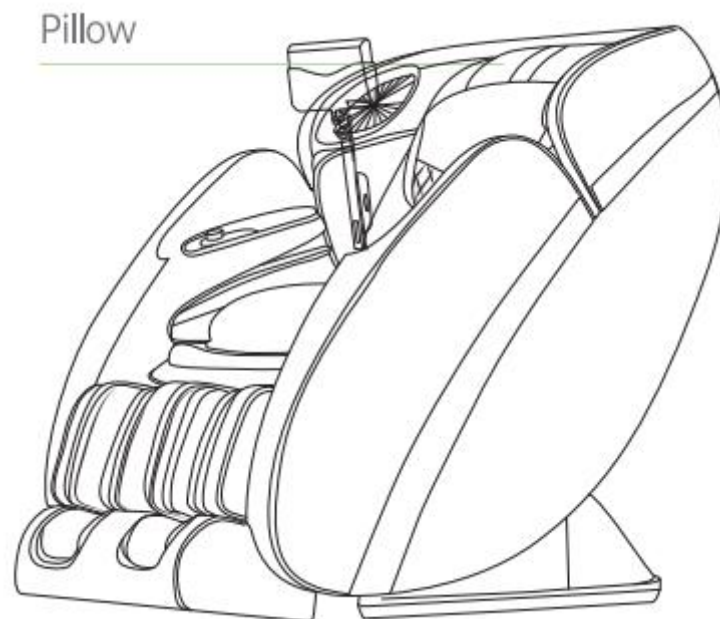

WARNING

- Make sure there is no foreign matter in the seams of the product.
 - Before sitting on the product, make sure there is no foreign matter between any two parts of it.
 - Do not put hands, arms or head between the backrest and the back cover.
 - Do not put pets on the product (such as its back cover, backrest and armrests).
3. Turn on the power
- Push the power connector into the appliance inlet till the end

- Insert the power plug into the power outlet till the end.
- Turn the switch to "I" position.

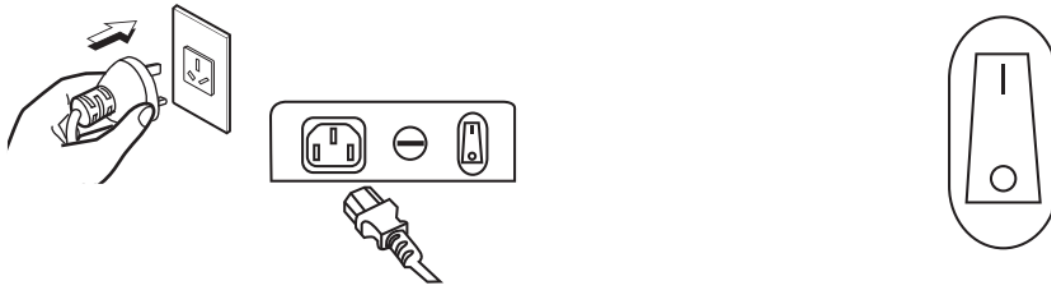

After use instruction

Please press "ON/OFF" button after using. Massage rollers will restore to its original position. Then switch the power supply button under the chair to "O" and unplug the machine from the wire socket.

Specification and Dimension

Model NO.	AT-6602
Power supply	220-240/50~60Hz
Rated Power	105W
Rated time	15 minutes
Dimension (L*W*H)	Upright: 157*78*124CM
	Recline: 188*78*99 CM
	Packing: 148.5*81*127.5CM
Weight	N.W.: 93Kgs
	G.W.: 111Kgs

Troubleshooting

This page summarizes the most common problems you could encounter with the product. if you are unable to solve the problem with the information below, please contact the service center immediately.

if the problem encountered is not listed, please try the following suggestions:

1. Turn off the product and unplug it.

2. Wait for 60 minutes.
3. Plug the product back to the mains and restart.
4. If the problem persists, contact the authorized service center.

Problem	Possible cause	Suggestion
The product does not work	The product is not plugged in properly.	Ensure the voltage on the product corresponds to the local mains voltage and then plug in again.
	The product has just finished its auto timer session and has automatically switched to standby mode.	If you want another session,press the Power button again.
	You may have used the product continuously for 45 minutes where the overheat protection has been activated.	Unplug the product and let it cool down for 60 minutes before you use it again.
	An excessive load has been applied to the product.	Reduce the excessive load and start again.
The product is abnormally warm	The product is likely to be overused.	Unplug the product and let it cool down before using it again.
Noise can be heard from the product.	Noise is made by the mechanical parts of the product.	Unplug the product and let it cool down before using it again.

Contact us

For any inquiries or quality-related issues concerning our products, Please send email to info@alpha-techno.com or call 09341/9285-0

We will respond to you as soon as possible and give you an appropriately solution.

Alpha Techno GmbH

Ernst-Bauer-Str.1

97941 Tauberbischofsheim

Tel.: 09341/9285-0

Fax.: 09341/9285-28

Email: info@alpha-techno.com

Germany