

MULTIMEDIA

CARBEST 

Smart TV of the new generation

- All-round multimedia experience
- WiFi, DVB-S2 (SAT), DVB-C (Cable), DVB-T2 w/ HD (Terrestrial)
- Wide viewing angle
- Narrow housing
- Can also be operated via smartphone app
- With time shift function



12-24 VOLT	100~240 VOLT	DVB-T2 DVB-S2 DVB-C	HDMI	USB 2.0
CI+ SLOT	MPEG4	2.4 GHZ WLAN	VIDEO TEXT	

19" HD READY	49867**	326,-
22" FULL HD	49868**	337,-
24" HD READY	49869**	359,-

Further information can be found on page 429

** Available from Q2/2024

SRM
MECATRONIC
The outdoors in comfort.

ASR 900 Bluetooth series

Powerful, extremely flat antenna series with a parabolic diameter of 90 cm. Best TV entertainment also in peripheral regions such as Spain or Portugal. Available as a single or twin LNB version, each with skew function. Dimensions retracted: LxWxH 1050x850x190 mm, weight: 15.5 kg.

ASR 900 Flat Skew (Single)	49145	2371,-
ASR 900 Flat Skew DF (Twin)	49146	2502,-

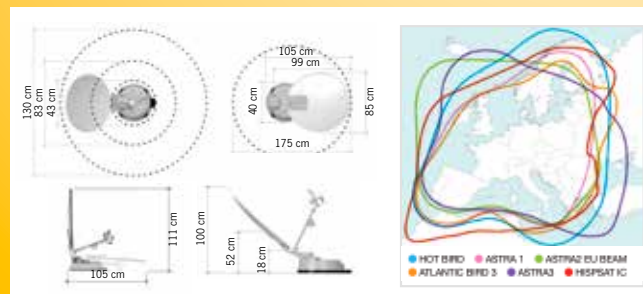

Further information and models can be found on page 445

LED & Smart TVs.....	428 – 424	Cable bushings & antenna accessories.....	455 – 457
TV and monitor holder	425 – 429	Rear view systems & cameras.....	458 – 465
SAT flat antennas.....	432 – 435	Navigation systems.....	466 – 469
SAT systems.....	436 – 447	Naviceiver and Infotainer & Accessories.....	469 – 471
Compact DVB-T2 antennas.....	448	Navigation infotainment system	472 – 473
Portable dome antennas.....	449 – 450	Car Radios & Accessories.....	473 – 474
LTE/WiFi antennas.....	451 – 453	Loudspeakers & sound systems.....	475 – 477
SAT Receiver/HD Sticks/SAT Finder.....	454		



Smart TV - powered by Android

- For an all-round multimedia experience
- WiFi, DVB-S2 (SAT), DVB-C (Cable), DVB-T2 with HD (Terrestrial)
- Wide viewing angle
- Extra slim housing
- Android operating system
- On/off switch on the device

9~30 VOLT	100~240 VOLT	DVB-T2 DVB-S2 DVB-C	H.265 DVB-T2
HDMI	USB 2.0	CI+ SLOT	MPEG4
WIFI	SCART VGA	VIDEO TEXT	HEVC 10 bit
FULL HD from 21.5"			

Devices type	18.5" HD READY	21.5" FULL HD	23.6" FULL HD	27" FULL HD
Screen format	16:9 widescreen format			
Viewing angle	178 / 178	176 / 176	178 / 178	178 / 178
Operating voltage	12V DC / 24V DC / 230V AC			
TV connections IN	1x HDMI, 2x USB 2.0, 1x VGA, 1x PC audio, 1x CI+ slot, 1x AV, 1x RJ45			
TV connections OUT	1x coaxial, 1x headphone			
Power consumption operation/standby	<36 W / <0.5 W			<48 W / <0.5 W
Resolution (pixels)	1366 x 768	FULL HD 1920 x 1080		
Contrast	3000:1	4000:1	3000:1	3000:1
Brightness (cd/m2)	200	200	200	240
Energy efficiency	F	F	F	F
Dims. (mm): w/o. base, WxHxD	436 x 259 x 43	502 x 297 x45	551 x 327 x 43	638x379x45/62
Dims. (mm): w/ base, WxHxD	436 x 304 x 160	502 x 342 x 160	551 x 369 x 180	638x416x187
Weight (without foot)	1,9 kg	2,3 kg	2,8 kg	3,8 kg
Scope of delivery	LED TV, stand/feet, power supply 100-240V, car adapter 12-30V with cigarette lighter plug, remote control, manual			
Item no. / Price	49881 294,-	49883 326,-	49885 359,-	49886 435,-

We reserve right to make technical improvements / changes, as well as to supply a qualitatively comparable product from another manufacturer or supplier in each case. The images are similar to delivered products. Dimensions without guarantee.

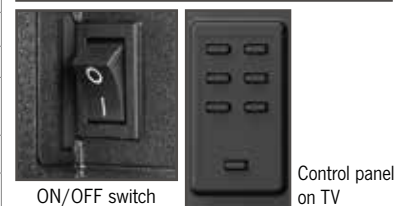

Smart TV of the new generation

- All-round multimedia experience
- WiFi, DVB-S2 (SAT), DVB-C (cable), DVB-T2 with HD (terrestrial)
- Wide viewing angle
- Narrow housing
- Can also be operated via smartphone app
- With time shift function
- Channel list playable - see reimo.com



- 12-24 VOLT
- 100~240 VOLT
- DVB-T2 DVB-S2 DVB-C
- HDMI
- USB 2.0
- CI+ SLOT
- MPEG4
- 2.4 GHZ WLAN
- VIDEO TEXT



Devices type	19" HD READY	22" FULL HD	24" HD READY
Screen format	16:9 widescreen format		
Viewing angle	170 / 170	176 / 176	178 / 178
Operating voltage	12V DC / 24V DC / 230V AC		
TV connections IN	2x HDMI, AV-in, 1x USB, 1x CI+ slot, RJ45	3x HDMI, AV-in, 2x USB, 1 x CI+ slot, RJ45	
TV connections OUT	1x coaxial, 1x headphone		
Power consumption operation/standby	<36 W / <0.5 W		
Resolution (pixels)	1366 x 768	FULL HD 1920 x 1080	1366 x 768
Contrast	1000:1	1000:1	1000:1
Brightness (cd/m2)	150	180	200
Energy efficiency	F	F	F
Dims. (mm): w/o. base, WxHxD	435 x 270 x 75	510 x 307 x 75	551 x 328 x 76
Dims. (mm): w/ base, WxHxD	435 x 286 x 132	510 x 340 x 165	551 x 377 x 180
Weight (without foot)	1,9 kg	2,3 kg	2,8 kg
Scope of delivery	LED TV, stand/feet, remote control, 100-240V mains adapter, 12V car adapter with cigarette lighter plug, instructions		
Item no. / Price	49867** 326,-	49868** 337,-	49869** 359,-



TV connections from 49868 and 49869

** Available from Q2/24

* You will find our warranty conditions on page 1080.

Oyster® Smart-TV

POWERED BY Avtex



Sizes :
19"
21,5"
24" 27"



- High-end device with ultra-flat design
- integrated 2.4 GHz and 5 GHz WLAN
- WLAN setup with WPS (compatible WLAN source required, e.g. Oyster® Connect, Oyster® Access and Oyster® EasyNet)
- Bluetooth 5.1
- Built-in tuner for DVB-S2, DVB-T2 tuner HD/H.265
- VIDAA operating system with full access to all apps in the Google Play Store, such as streaming services or web browsers
- HbbTV ("Hybrid broadcast broadband TeleVision")

- Multiple favorite channel lists (e.g. for D, AT, CH etc.)
- WIDI/Miracast
- OTA (Over-The-Air-Update - software update via Internet)
- Connectable via USB 2.0 and HDMI
- Freely nameable signal inputs
- Universal installation with VESA standard bracket
- System remote control: only one remote control for satellite system and Oyster® Smart TV set
- EPG electronic program guide with 7-day preview
- ON-SCREEN display for supply voltage
- "Audio only" function
- Barrier-free use
- CI / CI+ module slot
- Sturdy construction for mobile use in motorhomes & caravans
- Pre-programmed channel lists for D/AT/CH/FR and update support from ten Haaft
- Power switch On / Off
- Type approval mark according to KBA

Super class technology. Classic television and computer functions in one device. Bring the world of the Internet to your TV screen. Whether watching TV or streaming - with new smart TV series from Oyster® you have the all-round package on board.



*Energy consumption in on-state in kWh per 1,000 h when playing SDR content, rounded to the nearest whole number.

ten Haaft TV sets	Oyster® Smart TV 19"	Oyster® Smart TV 21.5"	Oyster® Smart TV 24"	Oyster® Smart TV 27"
EU energy efficiency	F	F	E	E
Screen size	19.5"/50cm	21.5"/55 cm	24"/61 cm	27"/69 cm
Annual energy consumption in kWh/year*	17 kWh / year	18 kWh / year	19 kWh / year	25 kWh / year
Power consumption standby /off mode	< 0,5 W	< 0,5 W	< 0,5 W	< 0,5 W
Resolution (pixels)	Full HD 1920 x 1080	Full HD 1920 x 1080	Full HD 1920 x 1080	Full HD 1920 x 1080
Viewing angle H/V	176° / 176°	178°/178	178°/178	178°/178
Tuner	DVB-S2, DVB-T2 HD/H.265	DVB-S2, DVB-T2 HD/H.265	DVB-S2, DVB-T2 HD/H.265	DVB-S2, DVB-T2 HD/H.265
WIFI	2.4 GHz + 5 GHz	2.4 GHz + 5 GHz	2.4 GHz + 5 GHz	2.4 GHz + 5 GHz
Loudspeaker Music output	2 x 2 W	2 x 2 W	2 x 2 W	2 x 2 W
Dimensions (W x H x D)	44,9 x 25,9 x 4,6 cm	49,2 x 29,0 x 4,7 cm	53,4 x 31,4 x 4,7 cm	61,9 x 36,4 x 4,7 cm
Weight	2,5 kg	2,9 kg	3,6 kg	4,6 kg
VESA standard	100 x 100 mm	100 x 100 mm	100 x 100 mm	100 x 100 mm
Operating voltage (w/mains adapter)**	12 V DC/24 V DC/230 V AC ¹	12 V DC/24 V DC/230 V AC ¹	12 V DC/24 V DC/230 V AC ¹	12 V DC/24 V DC/230 V AC ¹
1xHDMI/1xHDMI ARC/2 x USB 2.0	✓ / ✓ / ✓	✓ / ✓ / ✓	✓ / ✓ / ✓	(✓) / ✓ / ✓
Audio / Video in	3.5 mm AV jack socket AV in			
Headphones	3.5 mm stereo jack socket	3.5 mm stereo jack socket	3.5 mm stereo jack socket	3.5 mm stereo jack socket
Digital audio output	Cinch (RCA)	Cinch (RCA)	Cinch (RCA)	Cinch (RCA)
Power switch On/Off	✓	✓	✓	✓
CI/CI+ module slot	✓	✓	✓	✓
Item no.	49065	49066	49067	49068
Price	588,-	653,-	709,-	817,-

Oyster® Soundbar



- Elegant design combined with strong and clear sound
- Connections: HDMI ARC, COAXIAL, AUX
- USB interface for direct music playback
- 3 sound effects selectable (EQ): NEWS, Normal, Music
- Compatible with most televisions

Oyster® soundbar

Impressive sound, versatile connection options and elegant design. The Oyster® Soundbar has a 4-speaker system and is the **ideal complement to our "Oyster® Smart TV"** and is also compatible with other televisions. Installation is simple and the connection is made via HDMI ARC, COAXIAL or AUX. It is also possible to play music directly from a cell phone or tablet via USB or Bluetooth.

Features: Power: 2 x 10 W sine wave, energy consumption: 12 V 0.75 A / 24 V 0.42 A, operating voltage: 12 V, 24 V, 240 V (only w/ mains adapter), Dims.: 436 x 46 x 68 mm (W x H x D), Weight: 1.2 kg.

Scope of delivery: Soundbar, remote control, mounting bracket for direct mounting on "Oyster® TV", AUX cable, COAXIAL cable, HDMI ARC cable, 110 V - 240 V AC mains adapter with EURO Schuko plug, 12 V / 24 V power connection cable.

49029

191,-



Zahlreiche Auszeichnungen krönen die Qualität unserer Megasat-Produkte



Royal Line Premium - Smart TV w/ integrated DVD player

- LED display (pixel class 1)
- 1920 x 1080 pixel resolution (Full HD)
- 3000 : 1 contrast ratio / 220 cd/m² Brightness value
- Viewing angle: 178° (horizontal) / 178° (vertical)
- Tuner: DVB-S / -S2 / -C / -T / -T2 (H.265/HEVC)
- CI+ slot (HD+ ready)
- Bluetooth® 5.0 interface
- WLAN and LAN interface
- Access to media libraries / video portals and pre-installed apps
- DVD playback formats: DVD / DVD+R/+RW / DVD-R/-RW / VCD / CD / CD-R/-RW
- WebOS operating system
- ARM Quad-Core CA55X2, CA75X2 processor (1.5 GB DDR / 8 GB Flash)
- Supported formats: JPEG, BMP, PNG / MP3, AAC, AMR / MPG, AVI, TS, MOV, MKV, DAT, MP4, VOB
- 2x 5 watt stereo speakers
- 100 x 100 mm VESA standard

The Royal Line Premium series with integrated WebOS operating system offers a LAN and WLAN interface. As this is a smart TV, it has an internet browser and pre-installed apps as well as access to many media portals. In addition, numerous other apps can be installed via the integrated app store.

The TV experience is rounded off with a first-class HD quality display that leaves nothing to be desired.

The triple tuner also ensures digital TV reception in other European countries. Other features include the CI+ slot for decoding pay TV channels and the two USB ports for media playback of movies, pictures and music.

With the integrated Bluetooth® interface, you can wirelessly transmit audio playback to Bluetooth®-enabled headphones or a soundbar.

The devices are specially designed for use in vehicles. A special interior design protects the components from vibrations while driving. Whether boat, caravan or truck, with our camping TV you are well equipped.

Stand can be ordered optionally



Stand 22" & 24"	497005	21,70
Stand 27"	497006	21,70
Stand 32"	497007	21,70

TV sets	22 inch	24 inch	27 inch	32 inch
EU energy efficiency	E	E	E	E
Screen size	22" / 55cm	24" / 61 cm ✓	27" / 69 cm	32" / 81 cm
Annual energy consumption in kWh/year*	15 kWh / year	15 kWh / year	20 kWh / year	27 kWh / year
Power consumption standby / off mode	< 0,5 W	< 0,5 W	< 0,5 W	< 0,5 W
Resolution (pixels)	Full HD 1920 x 1080	Full HD 1920 x 1080	Full HD 1920 x 1080	Full HD 1920 x 1080
Viewing angle H/V	178°/178°	178°/178°	178°/178°	178°/178°
Tuner	DVB-S/S-2, DVB-T/T-2, DVB-C	DVB-S/S-2, DVB-T/T-2, DVB-C	DVB-S/S-2, DVB-T/T-2, DVB-C	DVB-S/S-2, DVB-T/T-2, DVB-C
WIFI	2.4 GHz + 5 GHz	2.4 GHz + 5 GHz	2.4 GHz + 5 GHz	2.4 GHz + 5 GHz
Loudspeaker Music output	2 x 5 W	2 x 5 W	2 x 5 W	2 x 5 W
Dimensions (W x H x D)	49,7 x 32,2 x 11,0 cm	54,2 x 34,6 x 11,0 cm	61,3 x 35,7 x 11,0 cm	72,3 x 45,8 x 17,0 cm
Weight	2,6 kg	3,3 kg	4,0 kg	5,7 kg
VESA standard	100 x 100 mm	100 x 100 mm	100 x 100 mm	100 x 100 mm
Operating voltage	12 V DC/24 V DC/230 V AC	12 V DC/24 V DC/230 V AC	12 V DC/24 V DC/230 V AC	12 V DC/24 V DC/230 V AC
3xHDMI/2 x USB 2.0	✓/✓/✓	✓/✓/✓	✓/✓/✓	(✓)/✓/✓
Audio / Video in	3.5 mm AV jack socket AV in			
Headphones	3.5 mm stereo jack socket	3.5 mm stereo jack socket	3.5 mm stereo jack socket	3.5 mm stereo jack socket
Digital audio output	Optical	Optical	Optical	Optical
Power switch On/Off	✓	✓	✓	✓
CI/CI+ module slot	✓	✓	✓	✓
Item no.	497001	497002	497003	497004
Price	479,-	523,-	577,-	632,-



- 2 full range speakers
- Max. 48 watts (2 x 24 watt integr. amplifier)
- Volume control w/ rotary knob (incl. on/off switch)
- Power supply: 5 volts (via USB)
- LED display for operation

Soundbar 1 - The perfect sound extension for your camping TV

The soundbar is supplied with power via the TV's USB port and audio signals are then transmitted via the headphone socket. It is attached to the underside of the TV using the bracket supplied. The broadband stereo speakers w/ a maximum output of 48 watts provide a pleasant sound & replace standard speakers integrated in TV. Simple and compact design of the soundbar fits in anywhere and is perfect for all camping televisions. Dims.: W 400 mm, H 60 mm, D 55 mm, weight 410 g.

498170 54,40



Side view (490008, 490009) Base and 230V cable not included.

Avtex Full HD Smart TV with WebOS

- 12 V Smart TV w/ LG WebOS operating system
- Complete European platform with country-specific content providers
- Renowned content providers, incl. Netflix, Prime, Disney+, Sky Store, Alexa, YouTube, Joyn, etc...
- High-quality, elegant design in matt brushed black
- Access to LG App Store & software updates
- Full HD Smart TV w/ integrated HD satellite decoder
- Built-in FreeSat satellite decoder w/ 7-day EPG
- Ultra-compact design from edge to edge
- Integrated Wi-Fi 2.4 & 5Ghz & Bluetooth connectivity
- Wireless transmission from your mobile devices (Android and iOS)
- Timer recording from the program guide (EPG)
- Pause/playback of live TV/fast recording to external HDD
- Voice control (optional with Magic Remote)
- 230V AC / 12V / 24V
- Scope of delivery: Avtex Smart TV, 12V plug, remote control (incl. 2 batteries)



Side view (490005, 490006, 490007) Base and 230V cable not included.

The new Avtex Smart TVs are packed with new functions and content. Connect your TV to the Internet and discover a whole new world of entertainment with premium streaming services such as Netflix, Amazon Prime, Now TV, Sky Store, Disney+, YouTube, BBC iPlayer and much more!

12~30 VOLT	100~230 VOLT	DVB-T2 DVB-S2	HDMI	WIFI	Bluetooth
USB 2.0	CI+ SLOT	MPEG4	VIDEO TEXT	HEVC 10 bit	LG App Store

Optional Accessories for Avtex Full HD Smart TV:

230 V cable	490010	34,90
TV stand for 19.5"-24"	490011	32,70
TV stand for 27"-32"	490012	43,60

Smart TV	Avtex® TV 19,5"	Avtex® TV 21,5"	Avtex® TV 24"	Avtex® TV 27"	Avtex® TV 32"
Type	W195TS	W215TS	W249TS	W279TS	W320TS
Energy efficiency	F	F	F	F	F
Screen size	19.5"/50 cm	21.5"/55 cm	24"/61 cm	27"/68.5 cm	32"/80 cm
Resolution (pixels)	Full HD 1920 x 1080	Full HD 1920 x 1080	Full HD 1920 x 1080	Full HD 1920 x 1080	Full HD 1920 x 1080
Viewing angle H/V/response time	178°/178	178°/178	178°/178	178°/178	178°/178
Tuner	DVB-T & DVB-T2, DVB-S & DVB-S2 digital HD				
Loudspeaker Music output	2 x 5 W	2 x 5 W	2 x 5 W	2 x 5 W	2 x 5 W
Dimensions (W x H x D)	44,8 x 25,7 x 4,6 cm	49,1 x 28,8 x 4,6 cm	53,9 x 31,7 x 4,7 cm	62 x 36,4 x 4,7 cm	72,1 x 42,2 x 4,2 cm
Weight (with base, not included)	2,7 kg	2,9 kg	3,2 kg	4,5 kg	5,8 kg
VESA standard	100 x 100 mm	100 x 100 mm	100 x 100 mm	100 x 100 mm	100 x 100 mm
Operating voltage ^(1)withmains adapter)	12 V DC/24 V DC/230 V AC ¹				
2xHDMI/2 x USB	✓ / ✓	✓ / ✓	✓ / ✓	✓ / ✓	✓ / ✓
Audio / Video in	3.5 mm AV jack socket/adaptor to RCA / Cinch**				
Headphones	3.5 mm stereo jack socket				
Digital audio out	optical TOS				
Power switch On/Off	✓	✓	✓	✓	✓
CI/CI+ module slot	✓	✓	✓	✓	✓
Item no.	490005	490006	490007	490008	490009
Price	490,-	544,-	621,-	741,-	791,-

Avtex Full HD Smart TV with VIDAA



- Smart TV with integrated HD satellite decoder
- Full HD LED display resolution 1920 x 1080
- DVB-T & DVB-T2 digital tuner
- DVB-S & DVB-S2 Digital HD satellite tuner
- Integrated Wi-Fi 2.4 & 5Ghz
- Freeview Play with reverse EPG
- Streaming via Netflix, Disney+ etc. possible
- Bluetooth connectivity
- Ethernet connection
- Integrated DVD player
- Instant recording to USB
- Timer recording from the program guide (EPG)
- W/ 3 HDMI connections & 1 HDMI ARC connection
- Optical audio output
- 2 USB ports
- Wall mounting VESA 100mm x 100mm
- On/off switch
- 12V / 24V / 240V operation
- Ultra-compact frameless design
- Scope of delivery: Avtex Smart TV, 12V plug, remote control (incl. 2 batteries)



The new Avtex SmartTVs have all the advantages of a fully-fledged smart TV and also have an integrated DVD player. The slimmest Avtex TVs to date offer you frameless television. With an internet connection, you get access to a whole new world of entertainment through premium streaming services such as Netflix, Amazon Prime, Disney+, YouTube, etc. Wirelessly transfer photos, videos & music from your mobile directly to your TV. Watch Full HD via your normal antenna or satellite dish, without additional equipment.

12~30 VOLT	100~230 VOLT	DVB-T2 DVB-S2	HDMI	WIFI	Bluetooth
USB 2.0	CI+ SLOT	MPEG4	VIDEO TEXT	HEVC 10 bit	DVD player

Optional Accessories for Avtex Full HD Smart TV:

230 V cable	490010	34,90
TV stand 21.5" and 23.8"	490011	32,70

Smart TV	Avtex® TV 21,5"	Avtex® TV 23,8"
Type	V219DS	V249DS
Energy efficiency	F	F
Screen size	21.5" / 55 cm	23.8" / 60 cm
Resolution (pixels)	Full HD 1920 x 1080	Full HD 1920 x 1080
Viewing angle H/V/response time	178°/178	178°/178
Tuner	DVB-T & DVB-T2, DVB-S & DVB-S2 digital HD	
Loudspeaker Music output	2 x 5 W	2 x 5 W
Dimensions (W x H x D)	48,9 x 29 x 4,4 cm	54 x 31,7 x 4,4 cm
Weight (with base, not included)	2,9 kg	3,36 kg
VESA standard	100 x 100 mm	100 x 100 mm
Operating voltage ^(1)withmains adapter)	12 V DC/24 V DC/230 V AC ¹	
3xHDMI/2 x USB	✓ / ✓	✓ / ✓
Audio / Video in	3.5 mm AV jack socket/adapter to RCA / Cinch**	
Headphones	3.5 mm stereo jack socket	
Digital audio out	optical TOS	
Power switch On/Off	✓	✓
CI/CI+ module slot	✓	✓
Item no.	490013	490014
Price	653,-	686,-



27"



SLA Line+ DW model series Smart TVs for internet and streaming

- Integrated soundbar underneath the TV set
- DVD player included
- Next generation WebOS Hub
- Triple tuner (DVB-S/S2, DVB-T/T2, DVB-C)
- CI+ slot and HbbTV
- Apple AirPlay & HomeKit support
- Wide-angle displays of highest quality class
- WIFI 2.4 GHz / 5 GHz and Bluetooth® version 5.0
- Including DVB-T antenna (AN5)
- Magic Remote control included

DVB-T2 DVB-C2 DVB-S2	DVD PLAYER	CD PLAYER	HDMI	2x USB 2.0	CI+ SLOT
HDTV	MPEG4		BLUE- TOOTH VERSION 5.0	FULL HD	12V 230V



24"



Experience first-class sound with new SLA-Line+. Alpatronics presents the next, improved generation of mobile televisions. Equipped w/ an integrated soundbar, WebOS Hub, a triple tuner (DVB-S/S2, DVB-T/T2, DVB-C), HbbTV, CI+, DVD player (feed on the right of the device), 2x USB connection, 2 x HDMI™ connection, Bluetooth® 5.0, SPDIF connection, Apple AirPlay & HomeKit support. The scope of delivery also includes the AN5 DVB rod antenna and the Magic Remote remote control.



22"



DVB-T rod antenna AN 5 at all alpatronic TVs included



DVB-T rod antenna AN 5 (as replacement or accessory)

Active DVB-T/T2 antenna for indoor use. Power supply (5 V) directly via the DVB-T receiver/TV or via 12 V DC. Delivery includes connection cable. Dimensions: 162x70 mm, weight: 143 g. **49750 29,50**

Devices type	22 inch - SLA-Line+	24 inch - SLA-Line+	27 inch - SLA-Line+
Screen format		16:9 LED	
Screen size (inch)	22	24	27
Dims. without base (cm)	W50.2 x H33.0 x D5.0	W55.3 x H34.1 x D5.4	W62.2 x H37.5 x D5.3
Weight (without foot)	3,4 kg	3,95 kg	5,2 kg
Resolution (pixels)	1920 x 1080 Full HD	1920 x 1080 Full HD	1920 x 1080 Full HD
Reception	DVB-T/T2, DVB-C2, DVB-S/S2	DVB-T/T2, DVB-C2, DVB-S/S2	DVB-T/T2, DVB-C2, DVB-S/S2
Contrast	1000:1	1000:1	1000:1
Brightness (cd/m²)	350	300	250
Viewing angle	178 H, 178 V	178 H, 178 V	178 H, 178 V
Inputs/outputs	Antenna, SAT, 2 x HDMI, HDMI ARC, 2 x USB, SPDIF, headphones, AV in, LAN		
Media playback	CD, DVD, VCD, MP3, DVD-R, DVD-RW, DivX, JPEG		
Energy efficiency	E		
Annual Energy consumption (1000 h)	15 kWh / year	18 kWh / year	21 kWh / year
Further features	12/230 Volt, 16.7 million display colors, PAL/SECAM, teletext, 5 picture modes/5 sound modes, 2 x 5 W, sleep timer, dual band WiFi (2.4 GHz / 5 GHz), VESA standard, HD Ready, from 22" FULL HD.		
Item no. / Price	497010 632,-	497011 719,-	497012 762,-

We reserve the right to make technical improvements or changes and to supply a product of comparable quality from another manufacturer or supplier. The images are similar to delivered products. Dimensions without guarantee. Technical data for all individual variants at www.alpatronics.de

Sky Basic" TV mount in anthracite

- ① **TV wall mount S**
 With locking mechanism for safe transportation.
 2 joints, swivel & tiltable. Arm length 122 mm.
 Material: steel, color: anthracite, hole spacing for TV mounting: VESA 75 mm and 100 mm.
 Load capacity: 7 kg. **49686** **80,70**
- ② **TV wall mount L**
 With locking mechanism for safe transportation.
 3 joints, swivel & tiltable. Arm length 122 and 210 mm. Material: steel, color: anthracite,
 Hole spacing for TV mounting: VESA 75 (75x75 mm) and VESA 100 (100x100 mm). Load capacity: 7 kg.
496861 **98,-**
- ③ **TV wall mount XL**
 With locking mechanism for safe transportation.
 3 joints, swivel & tiltable. Arm length 186 and 274 mm. Material: steel, color: anthracite,
 Hole spacing for TV mounting: VESA 75 (75x75 mm) and VESA 100 (100x100 mm). Load capacity: 7 kg.
496860 **119,-**

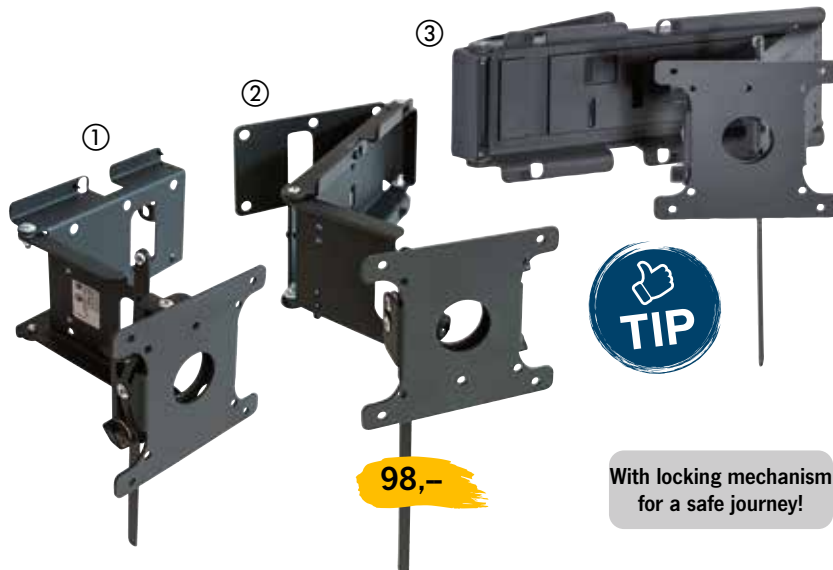

Caratec Flex TV mount with 3 pivot points

- With locking mechanism
 - Loadable up to 6.5 kg
- Compact holder with locking mechanism.
 Wall distance app. 370 mm when folded out.
 Load capacity: 6.5 kg. Weight: 1.4 kg.
 Dims.: app. B235 x H250 x D34 mm.
 Material: powder-coated steel
493985 **97,10**



Caratec Flex front pull-out

- Rotatable and swiveling
 - With automatic locking
 - Loadable up to 6.5 kg
- Automatically locking pull-out for TV cabinets, can be mounted horizontally or suspended, rotates & swivels. Allows the TV set to be pulled out by max. 470 mm, the rail length when extended is approx. 792 mm.
 Load capacity: 6.5 kg. Weight: 2.5 kg.
 Dims.: app. B180 x H85 x D370 mm.
 Material: Aluminum
493986 **228,-**



Caratec Flex lateral pull-out

- With automatic locking
 - Loadable up to 6.5 kg
- Classic TV pull-out with automatic locking, can be mounted on the left or right. Allows TV set to be pulled out by max. 470 mm, the rail length when extended is approx. 835 mm. Inclination of retaining plate: +/- 8 degrees.
 Load capacity: 6.5 kg. Weight: 2.6 kg.
 Dims.: app. W410 x H155 x D42 mm.
 Material: Aluminum
493987 **217,-**

SKY 20W TV linear drawer for wall mounting with shallow installation depth

- TV can be rotated up to 180° when extended
 - With locking while driving
- TFT wall mount SKY 20W (VESA 75+100). Pull-out with locking lever to secure the screen while driving. Cable routing included. Depending on installation situation, screen can optionally be rotated by 90° to achieve a shallower installation depth. Screen can be swiveled up to 180° when extended. Tilt adjustment +/- 10°. Silver anodized. Profile length: 330 mm, weight: 3.25 kg, load cap.: max. 6.5 kg. Dims. unassembled: 390 x 115 x 57 mm (L x H x D).
 Material: Aluminum profile. **49688** **300,-**



TV linear drawer SKY20C

- For horizontal mounting on the floor or cupboard base
 - Wide range of alignment options
 - Silver anodized
- Pull-out with locking lever to secure the screen while driving. Profile length: 330 mm, material: aluminum profile. Incl. Cable routing.
493951 **403,-**



TV AND MONITOR HOLDER

Delivery without monitor



folded

folded out and tilted

TV mount with large swivel range

- Wall lock and quick-release plate
- Large tilt angle (e.g. for high-hanging TFTs)
- Very light, with high load capacity (10 kg)
- TV bracket with locking bolt



SKY 10N TV bracket, 2-arm, 450 mm

With double-jointed arm, installation height 65 mm, arm length 200 mm each, extension 450 mm, weight 2 kg, load cap. up to 10 kg.

493940 258,-

SKY 10N TV bracket, 2-arm, 780 mm

With double-jointed arm, installation height 65 mm, arm length 350 mm each, extension 780 mm, weight app. 2.5 kg, load cap. up to 10 kg (not shown).

493942 272,-



SKY 12N TV mount

Wall bracket with 1 arm, arm length: 200 mm. Double joint, locking mechanism and quick-release plate for quick removal of the TV. Wall distance app. 280 mm. Weight: 1.5 kg. Loadable up to 12 kg. **493991 163,-**



SKY HF wall mount with quick-release

The small swivel and tilt TFT mount. Quick-Out System: TFT can be removed in one easy step. weight: 900 g, Dims.: 90x158x72 mm, load cap.: 10 kg. Wall distance: 72 mm. **493946 124,-**



Suction cup holder with quick release

For quick removal of the TV. Suction cup diameter 112 mm, weight 700 g, wall distance: 6 cm, load capacity: 10 kg. **493912 185,-**



① SKY 15N TV mount

Wall mounting w/ mounting rail. Holder can be rotated, swiveled, tilted & height-adjusted. Incl. 4 cable clips. Arm lengths: 46 cm and 26 cm, weight app. 2.5 kg, load cap. up to 10 kg. **493944 344,-**

② SKY 15N Wall rail

suitable for SKY 1 N. Better distribution of holding force on weak/thin walls. With concealed screw channel & 2 cover caps. Rail length 1050 mm. **493948 106,-**



Adapter plate Vesa Sky

for wall bracket Sky N and HF
Steel, powder-coated. Color: black, for Quick-Release 100 x 100, (for Vesa standard 200 x 100, 200 x 200, 300 x 170), weight 1 kg. **493950 45,80**

TV mount with large swivel range & locking mechanism



- Extremely flat (34 mm)
- With 3 pivot points
- With locking mechanism
- Very wide swivel range

Wall distance when folded out: 500 mm, dims.: W 296 x H 125 x D 34 mm, height with lever 250 mm, black powder-coated steel, load cap. up to 6.5 kg. With locking mechanism for safe transportation.

493971 108,-

SCANSTRUT®

- Extremely stable and high quality brackets
 - Simple locking with just one hand movement
 - A wide range of mounting options
 - Base with quick release
- All 3 components are required for mounting



Adjustable support arm 493460 61,-



Holding system with suction cup 493465 40,30



Tablet holder 493466 43,60



CARBEST Universal tablet/mobile holder

Perfect for mounting on headrest in vehicle or on bicycle handlebars. Suitable for smartphones and tablets. For appliance widths of app. 10 - 17.7 cm. 360° rotatable. **462381 25,10**

You can find more universal brackets in living comfort section on pg. 494

Wall Mount - TV wall mount

- Knurled screws for quick fixation
- For screens from 13 to 30 Inch
- Perforated rim 75 and 100 mm (VESA)

① TV Holder Simon Luxury

Secure locking while driving.
 Arm length 175 mm each.
 Length when unfolded 430 mm.
 Load capacity: Max. 10 kg.
 Weight: app. 1 kg.
 Material: Aluminum

Silver	493960	76,30
Black glossy	493983	76,30

② TV Holder Simon Luxury XL

Like TV holder Simon Luxus, but arm length 285 mm each. Length unfolded 650 mm.
 Load cap.: Max. 10 kg.
 Weight: app. 1.4 kg.
 Material: Aluminum

Silver	493970	87,20
Black glossy	493984	87,20

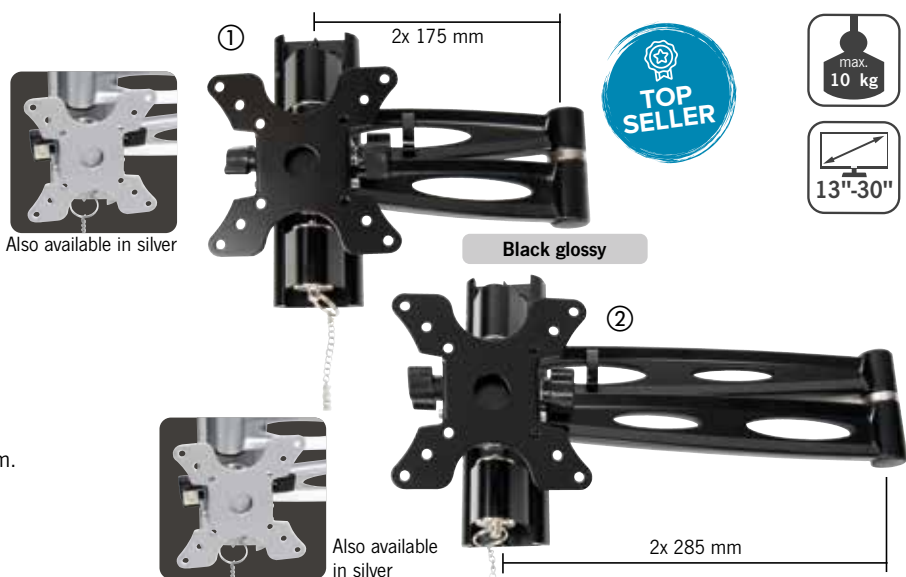

Wall Mount - TV wall mount

- Knurled screws for quick fixation
- For screens from 13 to 30 Inch
- Perforated rim 75 and 100 mm (VESA)

① Wall Mount TV Holder S

Load cap.: Max. 10 kg
 Dims.: 114 x 114 x 98 mm.
 Weight: 0.6 kg,
 Material: aluminum

Silver	493962	32,70
Black matte	493980	32,70

② Wall Mount TV Holder M

Load cap.: Max. 10 kg
 Dims.: 116 x 152 x 81 - 235 mm.
 Weight: 0.8 kg,
 Material: aluminum

Silver	493961	52,30
Black matte	493981	52,30

③ Wall Mount TV Holder XL

Load capacity: Max. 10 kg.
 Dims.: 116 x 152 x 81 - 390 mm
 Weight: 1 kg,
 Material: aluminum

Silver	49396	54,50
Black matte	493982	54,50

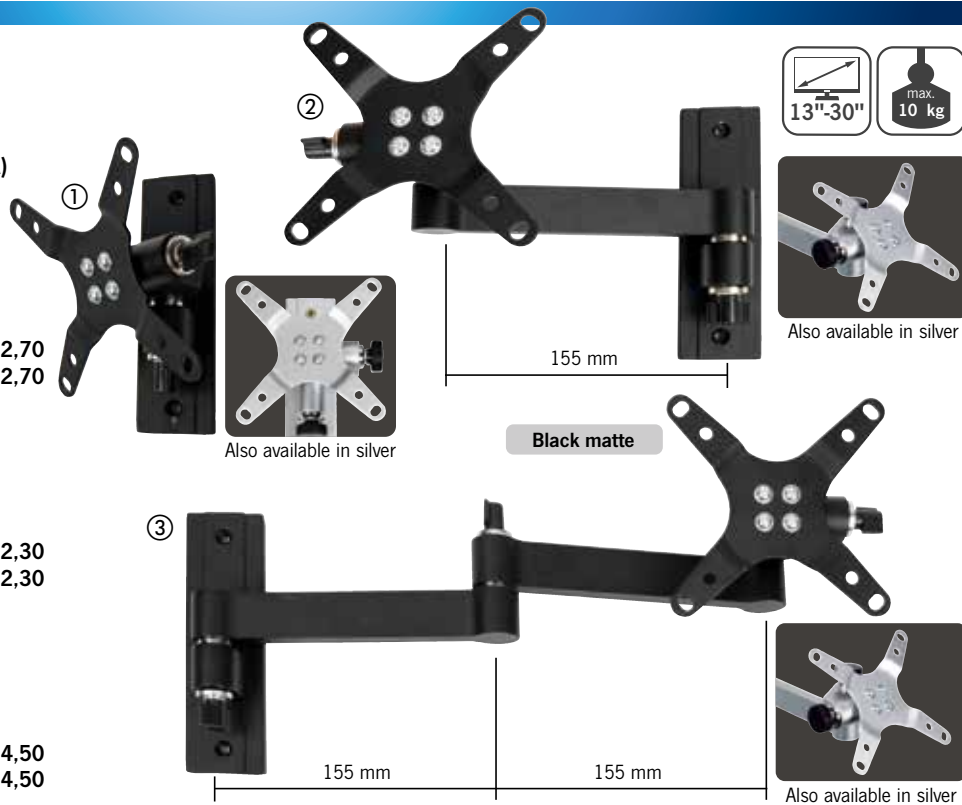

i Always secure your TV with a lashing strap before setting off!

Tensioning straps W/ rubberized inner surface.
 Available in 2 lengths.
 (Please also order retaining bracket)

① Belt length 110 cm. 1 pc.	74009	5,60
② Belt length 200 cm. 2 pcs.	44200	13,10
③ Retaining bracket for tension belts Material: metal, color: black, 2 pcs.	29471	10,20



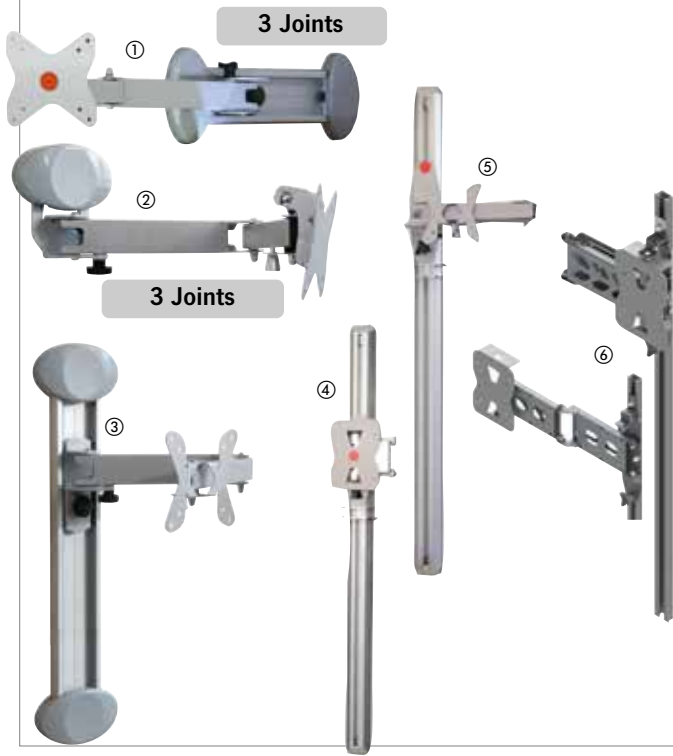

TV bracket for wall mounting

- ① **TV wall mount swivel & extendable**
 - Variable due to 3 joints
 - Can be moved on rails
 - Swivels out to 99 cm

max. load cap. up to 8 kg.
Weight: 1.95 kg.
Silver-colored, rail length 50 cm
43399 179,-
- ② **Tilt-adjustable TV wall mount**
 - Variable due to 3 joints
 - Swivel radius up to 54 cm

Blocking while driving.
Loadable up to 8 kg. Silver-colored.
W 314/496 x H 179 x D 85 mm.
Weight 1.3 kg. **49385 142,-**
W 386/648 x H 179 x D 85 mm.
Weight 1.5 kg. **49672 155,-**
- ③ **TV wall bracket, height-adjustable**
 - With height adjustment
 - Guide rail 99 cm

Silver-colored. Arm length: 427 mm.
Max. load cap. up to 8 kg.
Weight 1.9 kg. **49673 161,-**
- ④ **Monitor holder, height-adjustable**

with pull-out alignment, slide rail length 900 mm, load cap. up to 8 kg, weight 1.55 kg, max. extension 231 mm + 20 mm, depth of rail. Silver-colored. **49737 142,-**
- ⑤ **Monitor holder, height-adjustable**

with alignment, slide rail length 900 mm, loadable up to 8 kg, weight 1.65 kg, max. ext. 421 mm + 20 mm depth of rail, can be aligned up to 23° adjustable. Silver-colored. **49738 155,-**
- ⑥ **Monitor holder, height-adjustable**

Tilt option, can be mounted on left & right, load cap. up to 8 kg, weight 1.86 kg, max. ext. 443 mm. Silver-colored. **433990 130,-**



TV bracket for ceiling mounting

- ① **TV ceiling bracket with height adjustment**
 - Swivel & foldable

Rail: 343 mm. Loadable up to 10 kg. Automatic lock.
Closed: 343 x 114 x 58 mm.
Weight 2.0 kg. Silver-colored.
494521 89,-
- ② **TV ceiling bracket can be tilted & aligned.**
 - Swivel & foldable

Loadable up to 7 kg. Automatic lock.
Closed: 275 x 260 x 60 mm.
Weight 2.0 kg. Black.
49452 117,-

TV wall and cabinet bracket

- Console can be rotated and tilted. Loadable up to 10 kg

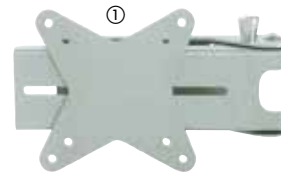

TV wall bracket

Max. loadable up to 10 kg. Closed dims.: L 210 x W 120 x H 47 mm. Weight 0.82 kg. Silver-colored.

49687 75,20

TV holder for cabinet mounting

For 8-15" Monitors.
W 260 x D 365 mm, extended 826 mm. Height adjustable. Swivels, can be tilted forwards. Space-saving, as it can be folded down 90°.
Weight 3.8 kg.

49386 130,-



Mobile TV holder with quick-change system

- Innovative quick-change system
- With 12 volt socket
- With built-in antenna socket

Removable TV holder with 12 V & TV aerial socket

Extendable up to 227 mm. Safety lock (locking while driving). Headboard can be rotated & tilted up to 10°.

Support device (remains attached to TFT) is removed from wall plate (remains on wall) using a detachable locking mechanism. The TV can thus be moved outdoors or hung with an additional wall plate (optional). Base is equipped with 12 V and TV socket.

Load capacity up to 8 kg, weight: 1.9 kg. TFT holder complete, black. **496801 109,-**

Additional wall plate (with 12 V & antenna socket) **496802 54,50**



Convert from "tube to TFT" now

- Conversion from tube device console to TFT attachment
- With brakes
- Loadable up to 8 kg

TV conversion attachment for swivel console

(for CRT sets) Convert your existing CRT set swivel console for TFT televisions. Remove mounting plate and attach conversion kit. Max. load capacity up to 8 kg. Button blocking. Closed dims. 275 x 260 x 60 mm. Weight of the attachment 1.55 kg.

49676 78,30

• (swivel bracket not incl. in SOD)



80,60



TV wall bracket

- Tiltable and swiveling
- Loadable up to 10 kg

Compact and robust TV mount with knurled screws for adjusting the tilt angle. The wall bracket can be tilted up and down. Swivels to the left and right. Weight 0.80 kg. Color: silver gray

49670 80,60



Delivery without monitor

Retractable TV holder

- Manually extendable upwards
- Installation in furniture or cabinet
- Monitor swivels right/left
- For monitors up to 19"
- Loadable up to max. 8 kg

Dims.: 500 x 475 x 110 mm. Weight 8.90 kg

Extension 440 mm, 23° pivotable	49679	301,-
Fixed position	496791	241,-
Pull-out 440 mm, 180° swiveling	496792	308,-

TV wall bracket, height-adjustable

- Pull-out right or left
- Max. Load capacity 8 kg
- Weight 2.875 kg
- Silver colored



Excerpt right	496783	180,-
Excerpt left	496784	180,-

Manual TFT pull-out, vertical

- Vertical pull-out from top to bottom
- Blocking in extended position
- Screen is 360° tiltable
- Silver colored



Small version

Dims.: 366 x 758 x 76 mm, weight 2.65 kg

496781 169,-

Large version

Dims.: 415 x 860 x 76 mm, weight 3.1 kg

496782 184,-

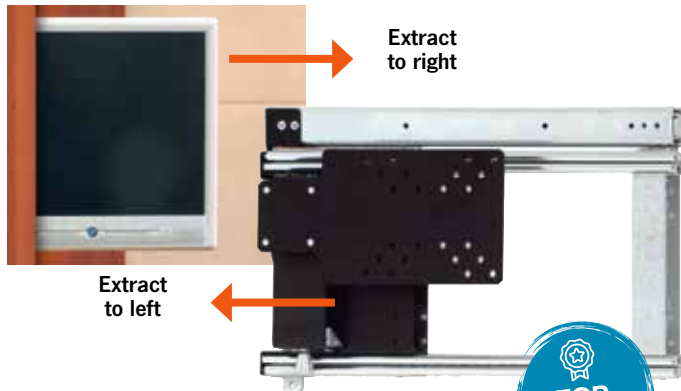

TV holder for cabinet installation

- Extendable to the side
- Very flat design
- Extendable with automatic locking in closed form
- Rail length 465 mm. Extension length 1017 mm
- When extended, monitor can be rotated up to 220°
- Load capacity up to 10 kg, weight 4.6 kg

Lateral pull-out to the right	493967	173,-
Lateral pull-out to the left	493968	168,-

Delivery without monitor

TV holder, vertically extendable

- Extendable from top to bottom, extension 385 mm
- When extended, additionally rotatable by 18° to right & left
- Blocking in extended position

Closed dims.: 195 x 310 x 65 mm, extension 385 mm, weight 2.9 kg, silver color.

49680 173,-

Delivery without monitor



Fully automatic twin LNB system for 2 receivers

- CAP 650 GPS Receiver-independent, incl. converter
- Automatic antenna retraction once engine starts
- Prepared for CAPcontrol Kathrein app

Technical data CAP 650:

OSD menu. Software update via converter. Automatic alignment to other satellites when changing channels. Emergency switch-off in case of overload.

Supply voltage (car battery): 11.5 - 13.8 V, current consumption from 12 V vehicle electrical system: switch-on current 10 - 12 A, satellite search 3 A, for TV reception 1.2 A, in stand-by 24 mA, from receiver 160 mA.

Installation height (lowered) only 21 cm. Weight of turntable and antenna: 14.5 kg. Total weight: 23.4 kg. Max. permissible driving speed: 130 km/h.

CAP 650 GPS: turntable, twin LNB, CAP converter with control unit suitable for any SAT TV set

491985 2070,-

HDP650GPS Dreheinheit: Twin LNB, no control unit therefore suitable for operation via Kathrein televisions

491990 1798,-



Reception area see BAS 66



Antenna set HDS 166 Plus

- Streaming of TV/radio programs on mobile devices such as smartphone or tablet PC
- Alignment of the antenna via smartphone app
- Twin LNB for connecting a second receiver or TV set
- Set up in a few simple steps

The HDS 166 Plus antenna can be conveniently aligned to desired satellite using a mobile (w/ compass & water trolley app). Depending on mobile and operating system, corresponding apps may already be pre-installed. Scope of delivery: BAS 66 flat antenna, HDS 100 satellite tripod, adapter joint, CAP converter, UFZ 132, 15m coaxial cable, carrying bag, installation instructions. Weight: approx. 9.4 kg

49124 653,-

Antenna set HDS 166

HDS 166 antenna set for manual satellite reception is an excellent alternative to the fully automatic, permanently mounted turntable. BAS 66 flat antenna included in set is ideal for setting and searching for satellites using a smartphone and a compass app (depending on the smartphone and operating system, such an app is already pre-installed).

Scope of delivery: BAS 66 flat antenna, satellite tripod for variable positioning of the BAS 66 and KEA 650 satellite antennas. Adapter joint, 15 m coaxial cable, carrying bag, installation instructions. Weight: approx. 8.8 kg

49121 414,-



Reception area
BAS 60/BAS 66/
CAP 620/CAP 650



With twin LNB

We recommend the following:
Mast 49215 or 49216 and
inclinometer 492928

Powerful TWIN Flat antenna BAS 66 with skew

- No protruding LNB
- Dirt-repellent coating
- Mobile or stationary use
- With 2 receiver connections

With a side length of 50 cm, it offers almost the same reception performance as a 60 cm dish antenna. Integrated twin LNB, analog & digital compatible. Frequency range from 10.70 - 12.75 GHz. Reception of ASTRA, Eutelsat - Hot Bird satellites. Mounting on pole HDM 140/141/143, dims. 500 x 500 x 109 mm. Weight 6.9 kg.

492221 283,-



Also with skew

HDZ 66 Skew Inclinometer

Installation set for flat antenna BAS 66/BAS 66 Skew. Simple alignment of antenna in conjunction with HDS 66 HDTV receiver (only w/ HDZ 66). Assembly in a few simple steps.

Skew Version 492927 108,-
492928 108,-

HDS 66 display + control unit

- Compatible with any receiver or TV set with integrated tuner
- Only suitable in conjunction with the HDZ 60 or HDZ 66 inclinometers
- Power is supplied via the receiver
- Two F sockets (IEC 169-24) as interface



49092 141,-

SPACE-SAVING FLAT ANTENNAS WITH VERY LARGE RECEPTION AREA

CARBEST 



HD
READY

With each
Sat receiver
to use.

SNIPE PRO HIGHLIGHTS:

- Active GPS receiver for short search times
- Automatic SKEW function
- Extremely flat, robust housing (H: 22.2 cm)
- 10 satellites pre-programmed, selectable on external control panel
- Extra reinforcement for high wind loads

SNIPE PRO MAX HIGHLIGHTS:

- Identical to SNIPE PRO, but with extremely high reception power (47dBW) and range



Comfort functions of Snipe PRO & Snipe PRO MAX:

Auto-Skew function, automatically compensates polarization shifts by rotating the receiving antenna. This ensures the best possible reception at all European locations. In addition, an active GPS receiver is integrated, which is kept in standby via built-in backup batteries without vehicle power. Search time to the satellite only 1 - 2 minutes. Wide angle for reception in Southern & Northern Europe (5 - 90°). Automatic retraction when vehicle is started. Auto-update of transponder data via satellite keeps Snipe always up to date. W/ DVB-S2 also ideally suited for HD television. Subject to technical changes.

Technical data for SNIPE PRO & SNIPE PRO MAX:

1-participant universal LNB. Frequency range: 10.7 - 12.75 GHz, Frequency band: Ku Band, Polarization: linear (horizontal/vertical), Reception power: 50 dBW, Antenna gain: 33.7 dBi (Snipe Pro) & 36.1 dBi (Snipe Pro Max), Angle ranges: Azimuth: 360°, Elevation: 5° ~ 90°, Skew: -60° ~ +60°. Temperature range: -20 to +60°C. Voltage range 12 to 24 volts. Power consumption: max. 75 W (search process)

10 Satellites pre-programmed:

Astra 1, Astra 2, Astra 3, Astra 4, Hotbird, Thor, Eutelsat 5 West A, Türksat, Hispasat, Eutelsat 9A.

Scope of delivery:

Antenna, control panel, bracket for control panel, 12V connection cable, 12 m coax cable for receiver & control panel, roof feed-through, mounting plate & operating instructions.

Dimensions and weights:

Snipe PRO: (LxWxH): 49.1 x 51.1 x 22.2 cm, Antenna closed: H: 22.2 cm, weight: 13.5 kg
Space requirement with maximum antenna rotation range: app. 640 mm.

Snipe PRO MAX: (LxWxH): 51.1 x 63.8 x 24.6 cm, antenna closed: H: 24.6 cm. Weight: 16.5 kg
Space requirement with max. antenna rotation range: app. 640 mm.

Snipe PRO	48295	1068,-
Snipe PRO MAX	48296	1144,-

Illumination zones Snipe PRO MAX

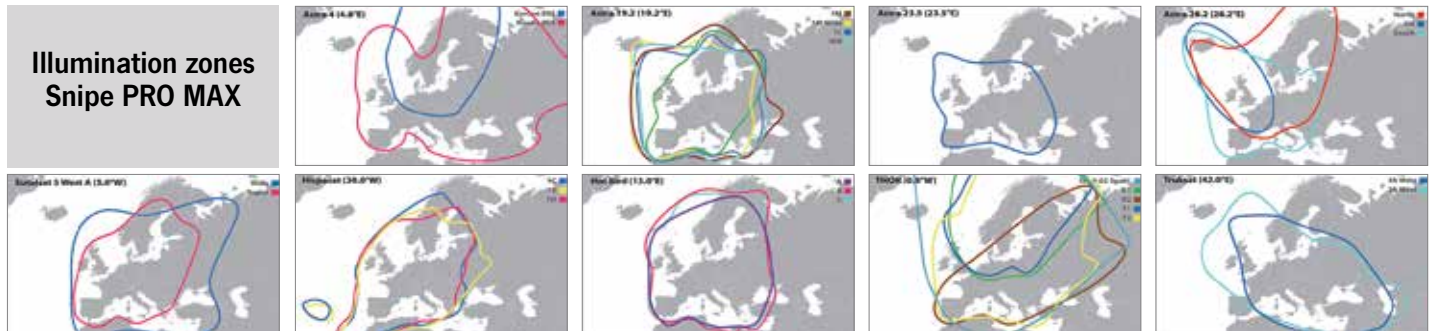

MEGASAT
Brillantes Fernsehen

Traveler-Man 3

- Fully automatic antenna w/ Bluetooth function for operation via smartphone
- Satellite selection & firmware updates directly via cell phone
- Free app for iOS and Android devices

Technical data: Antenna type: Flat antenna, LNB type: Universal LNB, Number of max. subscribers: 2, Frequency band: Ku band, Input frequency range: 10.7 GHz - 12.75 GHz, Polarization: V/H, Signal gain: 33 dBi @ 12.7 GHz, Minimum EIRP (footprint): 49 dBW, Elevation (tilt): 0° - 90°, Azimuth (rotation): 365°, Auto skew function, 2-axis DC motor, Temp. range: -25°C - +70°C, Power supply: DC 12 Volt, Dims. retracted: L 48 x H 14.5 cm.

Scope of delivery: Traveller-Man 3, control unit, roof ducts, 1m coaxial cable, 10m coaxial cable, operating instructions

496006	1307,-
---------------	---------------



AUTOMATIC FLAT ANTENNA FLAT ANTENNA - IDEAL FOR SPACE PROBLEMS

tenHaaft
Innovative Mobile Technology

CARO+ VISION

Elegant and extremely flat design

- One-cable technology
- APP operation, automatic updates via APP
- Fully automatic satellite detection & identification at the touch of a button
- Automatic retraction when vehicle is started (terminal 15 must be connected)
- Very small radius of action
- Extremely low installation height (app. 14 cm)
- Weatherproof, wind-resistant construction
- QM-certified manufacturer according to ISO 9001
- Reliable service
- Motor-controlled outdoor unit, complete w/ flat antenna & LNB
- SOD: mounting material, instructions & connection cable
- Type approval mark 10R - 068566

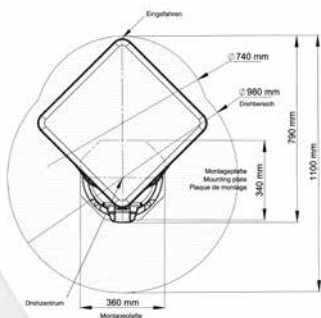

● Astra 1 ● Hotbird

Basic variant

Fully automatic satellite system w/o. receiver, especially for customers who only need a satellite system & already have their own receiver or a TV set w/ integrated receiver. Ø aerial mirror: 74 cm, rotation range: 98 cm. Ø mounting plate: 36 cm. Height/length when folded: 14/79 cm, weight app. 15 kg.

Antenna	Item no.	Price
Caro+ Vision Single	49309	2093,-

CARO+ PREMIUM



- Identical equipment to Caro+ Vision
- Benefit from Premium version:
Combine Caro+ Premium with an Oyster® TV Smart TV version and enjoy the advantage of operating antenna and TV with just one remote control

Premium variant

Fully automatic Premium version of satellite system, especially for customers who want convenient operation. This premium system allows you to operate the antenna and TV simply and easily with just one remote control.

Antenna	Item no.	Price
Caro+ Premium Single	49048	2093,-

Combine the Caro+ Premium antenna with a TV of your choice:

Oyster® SMART TV	Item no.	Price
19"	49065	588,-
21,5"	49066	653,-
24"	49067	709,-
27"	49068	817,-



Height: app. 14 cm
Weight: app. 15 kg

Caro+ Premium and Oyster® TV with just ONE Remote control



Cytrac^{DX} VISION



tenHaaft
Innovative Mobile Technology

Compact with gigantic reception range

- One-cable technology
- APP operation, automatic updates via APP
- Small, compact antenna for space-saving installation on vehicle roof
- Simple, easy and intuitive to use
- Fully automatic alignment and satellite detection usually in 30 to 60 seconds
- LEM technology: search time reduction (antenna searches at the last set tilt angle)
- Automatic retraction when vehicle is started (terminal 15 must be connected)
- High-quality processing of robust materials
- A solid, safe construction
- Type approval mark 10R - 068566

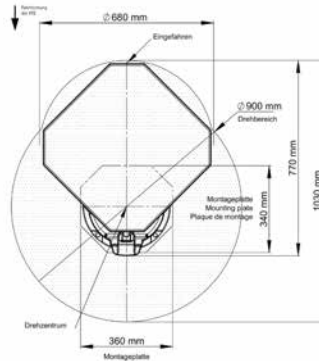

● Astra 1 ● Hotbird



Basic variant

Fully automatic Satellite system w/o. receiver, especially for customers who only need a satellite system & already have their own receiver or a TV set w/ integrated receiver. Ø antenna mirror: 68 cm, rotation range: 90°. Ø mounting plate: 36 cm. Height/length when folded: 14/77 cm, weight app. 16 kg.

Antenna	Item no.	Price
Cytrac DX Vision Single	49040	2393,-
Cytrac DX Vision Twin	49041	2595,-

Cytrac^{DX} PREMIUM

- Identical equipment to Cytrac DX Vision
- Benefit from Premium variant: Combine the Caro+ Premium with an Oyster[®] TV Smart TV variant and enjoy the advantage of operating antenna and TV with just one remote control

Premium variant

Fully automatic satellite system in premium version, especially for customers who want convenient operation. This premium system allows you to operate the antenna and TV simply and easily with just one remote control.

Antenna	Item no.	Price
Cytrac DX Premium Single	49046	2393,-
Cytrac DX Premium Twin	49047	2595,-

Patented Antenna-technology



Combine the Cytrac DX Premium antenna with a TV of your choice:

Oyster [®] SMART TV	Item no.	Price
19"	49065	588,-
21,5"	49066	653,-
24"	49067	709,-
27"	49068	817,-



Height: app. 14 cm
Weight: app. 16 kg



Cytrac DX Premium and Oyster[®] TV with only ONE Remote control



SAT SYSTEMS FROM HIGHEST QUALITY.

The satellite systems with Bluetooth control from SR Mecatronic are among the most technologically advanced on the market. They impress with their high quality and reliability. The robust mechanism with metal gear elements ensures a long service life and a low failure rate.



The SR Mecatronic Bluetooth app control offers you many advantages:

- Automatic software update, without technical assistance from customer service - switch the antenna on or off
- Manual control of the antenna if required
- Search and selection from the 19 pre-programmed satellites
- Checking the battery level, signal strength and signal quality
- App available for Android and iOS

Scan QR code and download the free app:



High processing quality and robust metal mechanism.

Optional Accessories for operating the antennas without a mobile or tablet:



LED control panel
7 pre-programmed satellites:
 Hotbird 13E, Astra 19, Thor, Sirius, Atlantic Bird, Hispasat, Astra 28.
 Scope of delivery: Control panel & connection cable to antenna
49724 163,-



Comfort "Plus" LCD control panel.
15 pre-programmed satellites & additional functions:
 Hotbird 13E, Astra 19E, Astra 28E, Eurobird 16E, Thor 1W, Sirius 5E, Atlantic Bird 5W, Hispasat 30W, Eurobird 9E, Eutelsat 7E, Eutelsat10E, Amos 3W, Atlantic Bird 8W, Atlantic Bird 12W, Astra 23.5E. Scope of delivery: Control panel & connection cable to antenna
49725 196,-

ASR 680 Bluetooth series

Robust, fast and quiet. With a parabolic diameter of 68 cm, you have excellent reception throughout Europe. Available as single or twin LNB version. Dims. retracted: LxWxH 790x630x215 mm, weight: 15.5 kg. Cable length: 5m. Scope of delivery: satellite system, cabling, installation & operating instructions.

ASR 680 (Single)	49133	1630,-
ASR 680 DF (Twin)	49134	1772,-

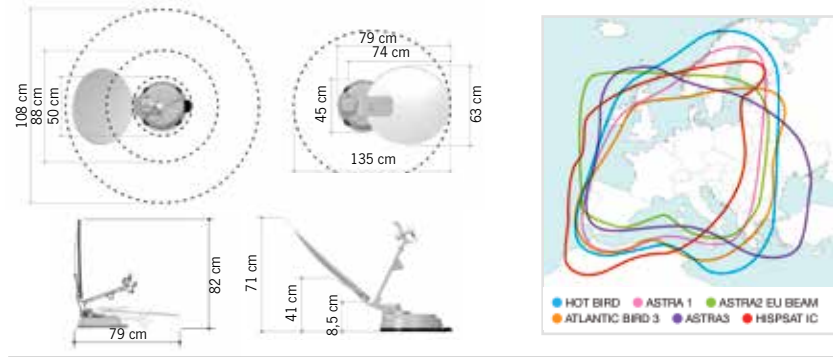

ASR 800 Bluetooth series

The parabolic mirror with a diameter of 80 cm also makes it possible to watch TV channels that are more difficult to reach. Available as single or twin LNB version, with or without SKEW. Dims. retracted: LxWxH 900x750x190 mm, weight: 15.8 kg. Cable length: 5m. Scope of delivery: satellite system, cabling, installation & operating instructions.

ASR 800 (Single)	49135	1837,-
ASR 800 Skew (Single)	49137	2371,-
ASR 800 DF (Twin)	49136	1979,-
ASR 800 Skew DF (Twin)	49138	2502,-

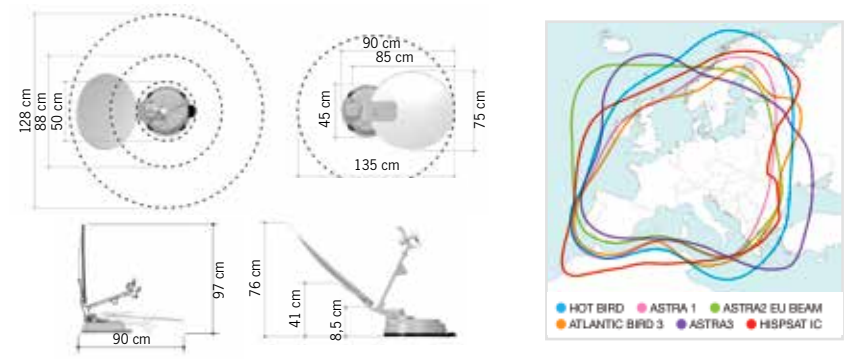

ASR 900 Bluetooth series

Powerful, extremely flat antenna series with a parabolic diameter of 90 cm. Best TV entertainment also in peripheral regions such as Spain or Portugal. Available as a single or twin LNB version, each w/ skew function. Dims. retracted: LxWxH 1050x850x190 mm, weight: 15.5 kg. Cable length: 5m. Scope of delivery: satellite system, cabling, installation & operating instructions.

ASR 900 Flat Skew (Single)	49145	2371,-
ASR 900 Flat Skew DF (Twin)	49146	2502,-

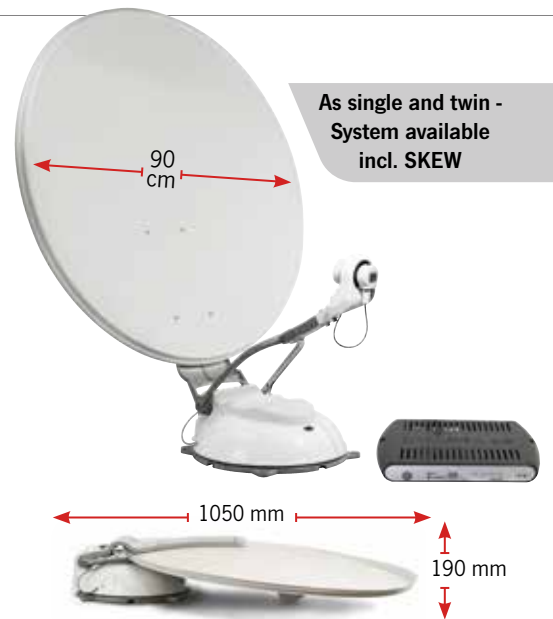
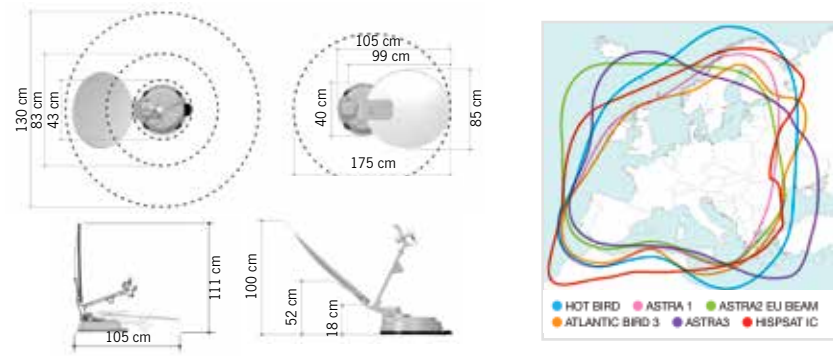

TRAVELSAT 68 II + 80 II
 PREMIUM SAT
 FACILITIES WITH
 BLUETOOTH
 CONTROL
 CONVENIENTLY VIA
 SMARTPHONE



Proven Travelsat quality with Bluetooth technology!

- All antennas with Bluetooth technology
- Convenient operation via mobile. Simply carry out software updates yourself using app, no more inconvenient workshop appointments
- Powerful LNBS for excellent
- TV reception even in outlying areas
- Powerful rotating mechanism and robust metal and aluminum components for a long service life and quiet operation

Technology: Travelsat II series with state-of-the-art hardware & software technologies. Easy to update & future-proof: HD & DVB-T2.

Control unit: The system is compatible w/ all decoders (including Sky HD). Reprogrammable software connection without opening the box.

Positioning: Quick search of satellite position.

Thanks to GPS, the search time is about 30-60 sec, 5-10 seconds when changing satellites. Automatic satellite alignment at the touch of a button. 1, 7 or 15 preset satellites. Saves the last recorded position. Acoustic signal warns when vehicle is started if antenna is open (plus).

Details: Aluminum mounting plate for secure & easy attachment to Vehicle High-precision gearbox made of steel & bronze: long service life with minimum maintenance.

Technical data:

12 Volt/27 Watt (max. 48 Watt when retracting and extending), -15°C to +50°C. With CI slot (Common Interface), OSD.

Scope of delivery:

Outdoor antenna, control unit without receiver, cable, roof duct, mounting material, mounting plate & instructions.

Travelsat II Ø 68 cm with Bluetooth Convenient control and software updates via app

Travelsat II Ø 68 cm, ASTRA single system (for 1 receiver). All other satellites can be selected via app or control panel. Cable length 5 meters.

Color anthracite	496380	1525,-
Color white	49638	1525,-

Travelsat II Ø 68 cm, ASTRA twin system (for 2 receivers). All other satellites can be selected via app or control panel. Cable length 5 meters.

Color white	49639	1656,-
--------------------	--------------	---------------



● HOT BIRD ● ASTRA 1 ● ASTRA2 EU BEAM
● ATLANTIC BIRD 3 ● ASTRA3 ● HISPSAT IC

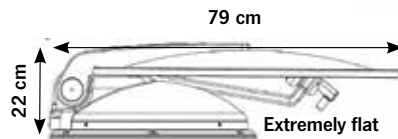

Travelsat II Ø 80 cm with Bluetooth

Travelsat II Ø 80 cm, ASTRA system w/ Bluetooth.

All other satellites can be selected via app or control panel. Cable length: 5 meters.

Single system (for 1 receiver) with Bluetooth	49640	1711,-
Single system (for 1 receiver) w/ Bluetooth & Skew	49641	2179,-
Twin system (for 2 receivers) with Bluetooth	49642	1852,-
Twin system (for 2 receivers) w/ Bluetooth & Skew	49643	2397,-



● HOT BIRD ● ASTRA 1 ● ASTRA2 EU BEAM
● ATLANTIC BIRD 3 ● ASTRA3 ● HISPSAT IC

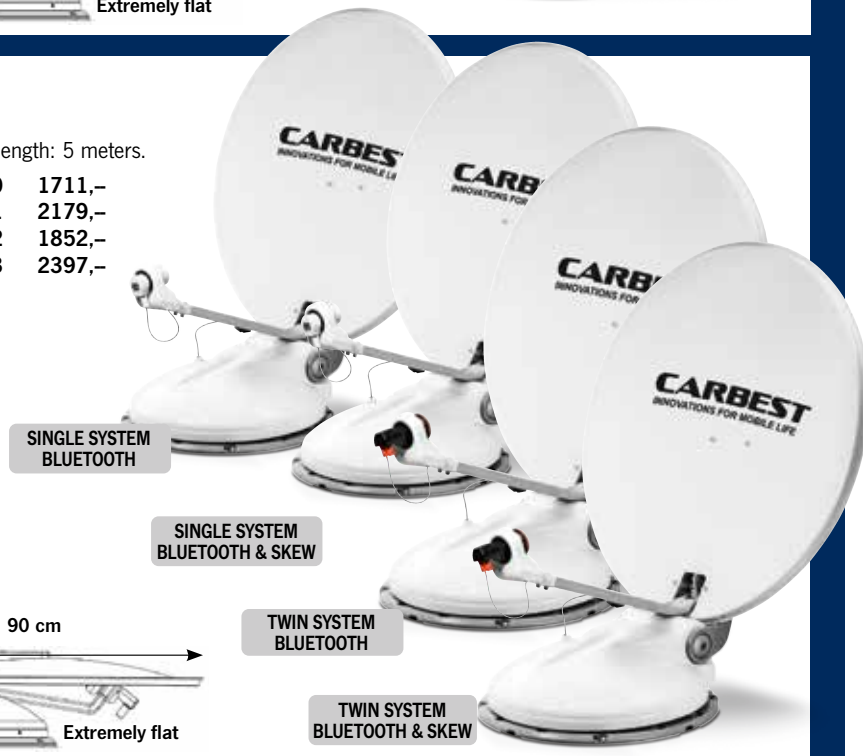
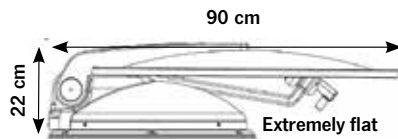

TWIN system: Twin system has a second satellite connection for additional digital or HD receiver, e.g. for TV in sleeping area. This enables independent program selection on both connections (receiver not included).

Service: The comprehensive SR-Mecatronic service network ensures fast repair or replacement in case of service. This means, Travelsat is quickly ready for use again.

Optional control panels: 2 control panels are available as alternative to Bluetooth control: LED control panel with 7 pre-programmed satellites and comfort "Plus" LCD control panel w/ 15 pre-programmed satellites.



LED control panel
7 pre-programmed satellites:
Hotbird 13E, Astra 19, Thor, Sirius,
Atlantic Bird, Hispasat, Astra 28.
49724 163,-



Comfort "Plus" LCD control panel.
15 pre-programmed satellites & additional functions:
Hotbird 13E, Astra 19E, Astra 28E, Eurobird 16E, Thor 1W, Sirius 5E, Atlantic Bird 5W, Hispasat 30W, Eurobird 9E, Eutelsat 7E, Eutelsat10E, Amos 3W, Atlantic Bird 8W, Atlantic Bird 12W, Astra 23,5E.
49725 196,-



*High quality
Automotive
engineering
for motorhomes,
Vans & Caravans*



**REISE
MOBIL**
INTERNATIONAL
KAUFTIPP
6/2022



**AUTO
ZEITUNGS**
**SEHR
EMPFEHLENSWERT**
REIMO
Reimo Carbest LT100BT
Ausgabe 18 / 2021



The Carbest catalog

Over 500 high-quality camping technology articles and vehicle accessories on more than 100 pages.

Now at your Reimo specialist dealer or request it free of charge at:
www.reimo.com/download_kataloge



Scan QR code
and catalog
download



Quality at a top price! MultiSatellite systems X85 Twin + Skew

- Automatic folding on engine start
- Extremely robust, maintenance-free metal drive
- Super easy operation, receive on Button to select the desired satellite

Technical data: 10 satellites pre-programmed, input frequency: 10.7 ~ 12.75 GHz, output frequency: 950 ~ 2,150 MHz, polarization: vertical & horizontal, angle range elevation: 0° ~ 145°, angle range azimuth: 390°, power supply: DC 12 Volt, operating temp.: -20° C to +60° C. Scope of delivery: Multi-Sat antenna, controller, roof feed-through, mounting plate, LNB protective film, connection cable, screws, operating instructions.

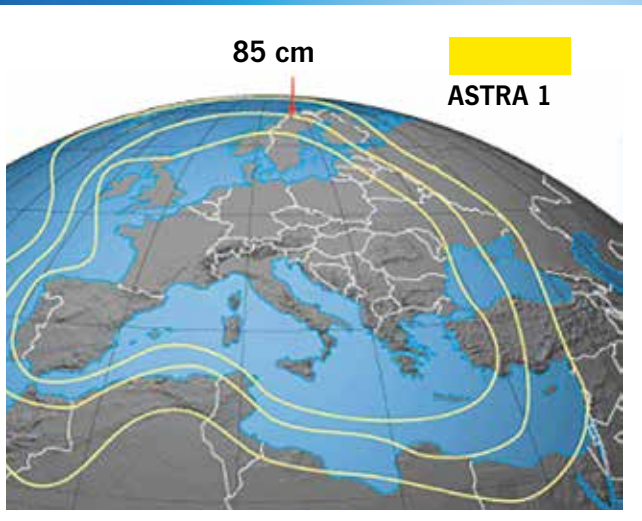

12V	Ø 85 CM	TWIN LNB	AUTO SKEW	GPS RECEIVER
10 SATELLITES PREPROGRAMMED	AUTOMATIC RETRACTION AT VEHICLE START	SATELLITE SEARCH RUN: APPROX. 180 SEC.	DiSEqC 1.0/1.1	COLOR: WHITE

Satellite Antenna Multi-Sat X85 Twin + Skew

10 satellites pre-programmed

SAT system Multisat 85 cm Twin LNB + AUTO SKEW, pre-installed satellites: **Turksat, Astra 2, Astra 3, Astra 1, Hotbird, Eutelsat 9, Astra 4, Thor, Eutelsat 5W, Hispasat**, compact yet high reception performance, satellite search time max. 180 sec., software update via USB, retracted dims.: 110.5 x 86 x 18.4 cm, weight: app. 14 kg **49633 1634,-**

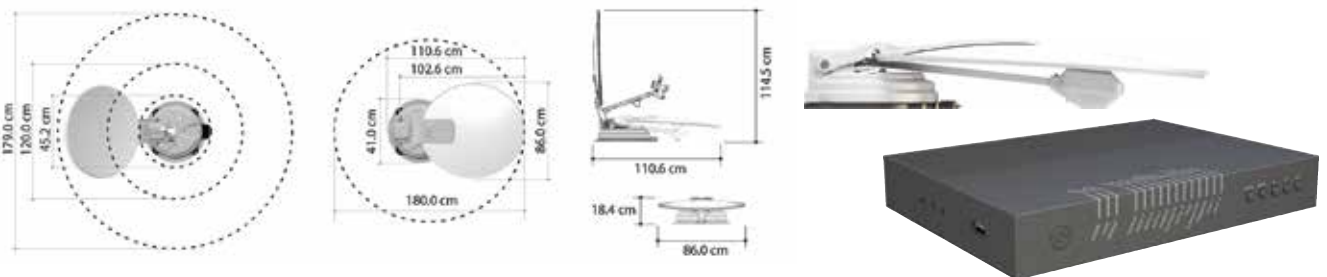

FULLY AUTOMATIC SAT SYSTEMS

MEGASAT
Brillantes Fernsehen



Caravanman 65 / 85 Premium V2 Caravanman 65 / 85 Professional GPS V2

Best radio and TV quality throughout Europe with the Caravanman. The 65 or 85 cm mirrors ensure ideal reception conditions even in the peripheral areas of the footprint. Another plus point is the low installation height of just 20 cm when retracted, which also allows installation on high vehicles. The included control unit, which now also offers an integrated Bluetooth® module that can be used to connect to a smartphone or tablet, automatically finds the selected satellite at the touch of a button. The Professional version also offers SKEW function that compensates for reception impairments caused by curvature of the earth.

Caravanman 65 Premium V2 & Professional GPS V2

- Robust and powerful
- Ideal for smaller vehicles
- Little space required on roof

Caravanman 85 Premium V2

- Robust and powerful
- For even more reception range
- Low installation height (only 20 cm)

Caravanman 85 Professional GPS V2

- GPS receiver for quick alignment of antenna
- Professional version with TWIN-LNB
- Automatic SKEW function
- For 2 receivers or TV with SAT receiver
- For even more reception range
- Low installation height (only 20 cm)

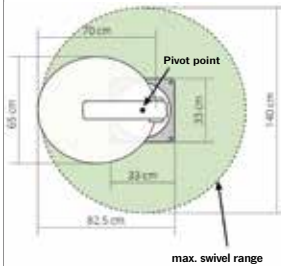

Figure Control panel

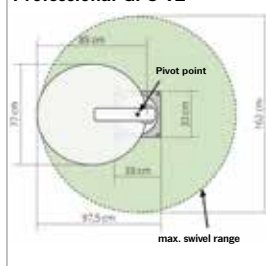

Figure Control unit

Caravanman 65 Premium V2/ Professional GPS V2



Caravanman 85 Premium V2/ Professional GPS V2



Compact in height

Height of the retracted antenna only 20 cm.



Technical data:	① Caravanman 65 Premium V2	② Caravanman 65 Professional GPS V2	③ Caravanman 85 Premium V2	④ Caravanman 85 Professional GPS V2
Number of participants	1	2	1	2
LNB type	Universal Single LNB	Universal TWIN LNB	Universal Single LNB	Universal TWIN LNB
Frequency band/frequency range	Ku Band/10.7 GHz to 12.75 GHz	Ku Band/10.7 GHz to 12.75 GHz	Ku Band/10.7 GHz to 12.75 GHz	Ku Band/10.7 GHz to 12.75 GHz
Signal amplification	35.1 dBi	36.8 dBi	36.8 dBi	36.8 dBi
Reception power	45 dBW	43,5 dBW	43,5 dBW	43,5 dBW
GPS receiver and auto skew	-	Yes	-	Yes
Polarization	H/V			
Motor control / tilt angle / search angle	2 - axis DC motor / 0° to 75° / 360°			
Inclination speed	10° per second			
Rotational speed	20° per second			
Operating temperature	-15° C to +50° C			
Preprogrammed satellites	Astra 1 (19.2° East), Astra 2 (28.2° East), Astra 3 (23.5° East), Hotbird (13° East), Thor (0.8° West), Eutelsat 9 B (9° East)			
Power supply	DC 12-24 V, 10 A			
Antenna dimensions (W/H/D) / weight	660 x 200 x 870 mm / 12.1 kg (net)		770 x 200 x 1000 mm / 13.3 kg (net)	
Control unit dimensions (W/H/D)	180 x 40 x 130 mm			
Scope of delivery	Antenna, control unit, control panel, connection cable, roof duct, operating instructions			
Item no.	49843	49844	49845	49846
Price	1416,-	1634,-	1525,-	1852,-



MEGASAT
Brilliantes Fernsehen

Caravanman Compact 3 with Bluetooth function

- Fully automatic antenna w/ Bluetooth function for operation via mobile, tablet or control unit
- Satellite selection & firmware updates directly via cell phone
- Free app for iOS and Android devices

Caravanman Kompakt 3 is the ideal antenna for caravans, panel vans or motor-homes w/ a small mounting surface. Despite the small mirror, strong reception even in the peripheral regions of Europe. Very compact design with high reception power and 10 pre-programmed satellites. The satellite can be selected either on control unit or via the app on the mobile device. The antenna is connected to the control unit with just one coaxial cable.

Technical data:

LNB type: Universal LNB, Frequency band: Ku-band, Input frequency range: 10.7 GHz - 12.75 GHz, Polarization: V/H, Signal gain: 33 dBi @ 12.7 GHz, Minimum EIRP (footprint): 49 dBW, Elevation (tilt): 15° - 62°, Azimuth (rotation): 360°, 2-axis DC motor, Control unit with Bluetooth module, Temp. range: -25°C - +70°C, Power supply: DC 12 volt, dims. when folded: W 46 x H 17 cm.

Scope of delivery: Caravanman Kompakt 3, control unit, roof duct, 1m coaxial cable, 10m coaxial cable, operating instructions

Caravanman Compact 3 Graphite Single	498204	1362,-
Caravanman Compact 3 Single	498202	1307,-

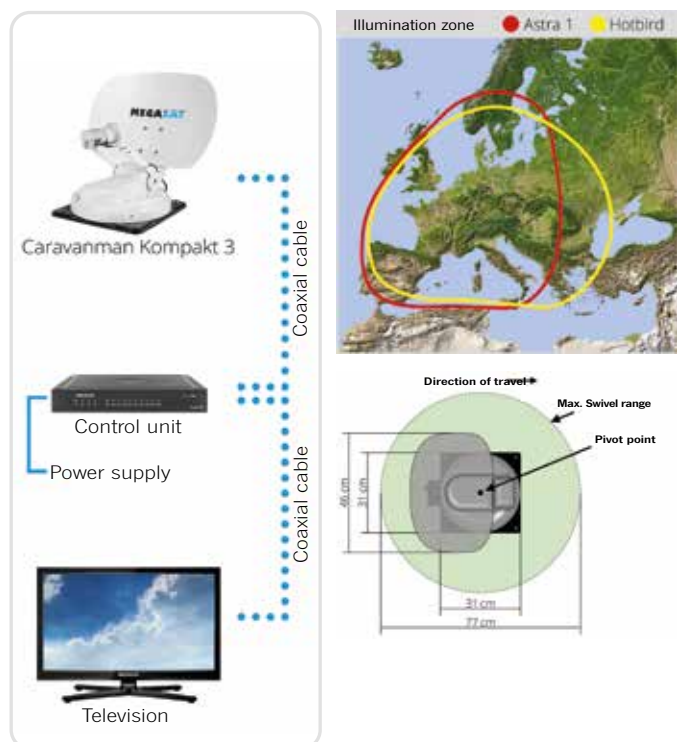



Reception range Oyster® 65



Reception range Oyster® 85



Oyster® VISION

- Automatic updates
- Simple operation via app
- 65 or 85 cm antenna mirror for pure range
- Fully automatic alignment & satellite detection
- Processing of high-quality and robust materials
- Solid, safe and weather-resistant construction
- Rotary head technology
- LEM technology: Antenna searches at the last set tilt angle (search time reduction)
- Automatic satellite change when changing channels
- Automatic retraction when vehicle is started (terminal 15 must be connected)
- Reliable service
- Type approval mark 10R - 068881
- Dims. Oyster® Ø 65:
Ø aerial mirror: 67 cm, turning range: 118 cm.
Height/length when folded: 22/92 cm, weight app. 12 kg.
- Dims. Oyster® Ø 85:
Ø antenna mirror: 85 cm, rotation range: 150 cm.
Height/length when folded: 22/111 cm, weight app. 12 kg.

Oyster® Vision	Item no.	Price
Ø 65 cm Vision Single	49326	2115,-
Ø 85 cm Vision Single	49327	2224,-
Ø 65 cm Vision Single Skew	493262	2393,-
Ø 85 cm Vision Single Skew	493273	2524,-

Oyster® Vision	Item no.	Price
Ø 65 cm Vision Twin	493261	2279,-
Ø 85 cm Vision Twin	493271	2398,-
Ø 65 cm Vision Twin Skew	493263	2595,-
Ø 85 cm Vision Twin Skew	493272	2704,-



Oyster® PREMIUM

- Identical features as Oyster® Vision, without control panel
- Benefit from Premium version: Combine Oyster® Premium with an Oyster® TV (Basic or Smart TV version) and enjoy the advantage of operating the antenna and TV with just one remote control

Oyster® Premium	Item no.	Price
Ø 85 cm Premium Single	49051	2224,-
Ø 65 cm Premium Single Skew	49050	2393,-
Ø 85 cm Premium Single Skew	49052	2524,-
Ø 85 cm Premium Twin	49053	2398,-
Ø 85 cm Premium Twin Skew	49054	2704,-

Oyster® PREMIUM 70

For the company's 30th anniversary, ten Haaft surprises with this system. Like all other Oyster® systems are easy to operate, even via APP, works reliably and fully automatically.



Reception range Oyster® 70

Oyster® 70	Item no.	Price
Vision Single	493260	1952,-
Vision Twin	493264	2121,-
Premium Single	493265	1952,-
Premium Twin	493266	2121,-

Dims. Oyster 70:

Ø aerial mirror: 67 cm, rotation range: 134 cm.
Height/length when folded: 17.5/86 cm, weight app. 11.7 kg.

Combine the Oyster 70 Premium antenna with a desired TV:

Oyster® Premium & Oyster® TV with just ONE Remote control



Oyster® SMART TV	Item no.	Price
19"	49065	588,-
21,5"	49066	653,-
24"	49067	709,-
27"	49068	817,-

Oyster® V VISION

- Single-cable technology, w/ control panel (w/o. receiver)
- Control panel for use with third-party televisions
- Simple operation & automatic updates via app
- GPS, 3D compass, tilt sensor for fully automatic alignment and satellite detection
- 85 cm antenna mirror for pure range
- Processing of high-quality and robust materials
- Solid, safe and weather-resistant construction
- Rotary head technology
- Automatic satellite change when changing channels
- Automatic retraction when starting the vehicle (terminal 15 must be connected)
- Reliable service
- Type approval mark 10R - 068566



Reception range Oyster® V
● Astra 1 ● Hotbird



Oyster® V Vision	Color	Item no.	Price
Ø 85 cm Vision Single	white	493274	2704,-
Ø 85 cm Vision Single	anthracite	493278	2704,-
Ø 85 cm Vision Single Skew	white	493275	3003,-
Ø 85 cm Vision Single Skew	anthracite	493279	3003,-
Ø 85 cm Vision Twin	white	493276	2878,-
Ø 85 cm Vision Twin	anthracite	493280	2878,-
Ø 85 cm Vision Twin Skew	white	493277	3183,-
Ø 85 cm Vision Twin Skew	anthracite	493281	3183,-

Oyster® V PREMIUM

- Features like Oyster® V Vision, without control panel
- Benefit from Premium version: Combine Oyster® V Premium with an Oyster® TV (Basic or Smart TV version) and enjoy the advantage of operating the antenna and TV with just one remote control
- Oyster® V Premium antennas & Oyster® TVs are perfectly matched to each other

Oyster® V Premium Base	Color	Item no.	Price
Ø 85 cm Premium Single	white	49095	2704,-
Ø 85 cm Premium Single	anthracite	490951	2704,-
Ø 85 cm Premium Single Skew	white	49063	3003,-
Ø 85 cm Premium Single Skew	anthracite	490631	3003,-
Ø 85 cm Premium Twin	white	49096	2878,-
Ø 85 cm Premium Twin	anthracite	490961	2878,-
Ø 85 cm Premium Twin Skew	white	49064	3205,-
Ø 85 cm Premium Twin Skew	anthracite	490641	3205,-



Dims. Oyster® V Ø 85:
Ø antenna mirror: 85 cm, rotation range: 193 cm.
Height/length when folded: 17/113 cm, weight app. 11 kg.

Combine the Oyster® V Premium antenna with a TV of your choice:

Oyster® SMART TV	Item no.	Price
19"	49065	588,-
21,5"	49066	653,-
24"	49067	709,-
27"	49068	817,-



Oyster® V Premium & Oyster® TV with just ONE Remote control

CAP 750 GPS, CAP 850 GPS incl. control unit

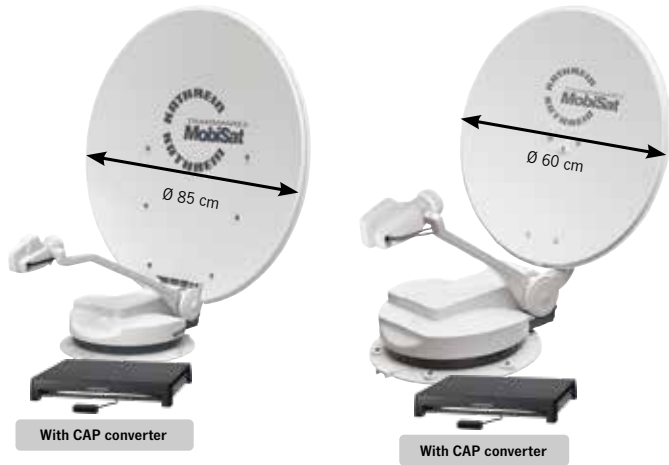

- The complete package for fully automatic HDTV satellite reception, incl. control unit
- Turntable with integrated control electronics, parabolic reflector with twin LNB and cable set
- Twin LNB for connecting a second receiver or TV set
- The entire turntable can be controlled via a connected receiver or TV set
- Automatic alignment to other satellites when changing channels
- Parabolic reflector w/ LNB pre-mounted on the turntable
- LNB for polarization adjustment manually adjustable
- Automatic lowering (park position) at engine start
- Emergency shutdown in case of overload
- Maximum permissible vehicle speed: 130 km/h
- Aerodynamic body only 21 cm (CAP 750), 17 cm (CAP 850) high (when lowered)
- With GPS for precise location determination
- Quick alignment of the antenna in <1 min.

CAP 750 GPS incl. control unit **491986** **1961,-**
 CAP 850 GPS incl. control unit **491987** **2103,-**

We reserve right to make technical improvements / changes, as well as to supply a qualitatively comparable product from another manufacturer or supplier in each case. The images are similar to delivered products. Dimensions without guarantee.

Type	CAP 750 GPS	CAP 850 GPS
Diameter	60 cm	85 cm
LNB	2 switchable outputs: V/H (14/18 V) - Low/High (0/22 kHz)	2 switchable outputs: V/H (14/18 V) - Low/High (0/22 kHz)
LNB supply voltage	Vertical: 11.5-14 V, Horizontal: 16-19 V	Vertical: 11.5-14 V, Horizontal: 16-19 V
Input frequency	10.7 - 12.75 GHz	10.7 - 12.75 GHz
Output frequency	950 - 1950/1100 - 2150 MHz	950 - 1950/1100 - 2150 MHz
Oscillator frequency (L.O.)	9.75/10.6 GHz	9.75/10.6 GHz
Supply voltage (car battery)	10,5 - 15,5 V	10,5 - 15,5 V
Current consumption from 12V vehicle electrical system: switch-on current/satellite search/TV reception/stand-by	Type. 10 max. 12 A/type. 3 A/Type. 1.2 A/type. 0,024 A	Type. 10 max. 12 A/type. 3 A/Type. 1.2 A/type. 0,024 A
Power consumption from receiver	Type. 160 mA	Type. 160 mA
Elevation/azimuth/skew adjustment range	0-75/370/± 45°	0-65/370/± 45°
Weight of turntable with parabolic reflector	9,7 kg	12 kg
Packaging unit/weight	1/19.5 pc/kg	1/24 pc/kg

HDS 50 - External control unit for CAP 650 GPS/750 GPS/850 GPS/950

- Simple operation of the turntable
- Without switching on the receiver or TV
- Selecting the satellite
- Lowering to parking position
- LC display for status information
- Simple wall mounting
- No separate power supply required
- Incl. 3m connection cable



49091 217,-



CAP converter

- Control unit for TVs with built-in receiver

The CAP converter is already included with fully automatic CAP turntables and new HDS 166 plus antenna set and serves as the central control unit. As a stand-alone product, it is particularly recommended for customers who want to convert their CAP turntables w/ receivers to a receiver-independent solution. Furthermore, with CAP converter and UFZ 131/UFZ 132 WLAN stick (see below), HDS 166 antenna set can also be expanded to include functions live TV on mobile/tablet and alignment w/ voice assistant.

49093 283,-



WLAN-USB-Adapter UFZ 132 - TV and radio via live streaming

- Live streaming on mobile devices
- Simple installation via the receiver menu
- Supports 2, 4 and 5 GHz ISM bands (dual band)
- Supports 64-/128-bit WEP, WPA, WPA2 and WAPI encryption

WLAN/USB adapter UFZ 132 enables wireless integration of suitable network-compatible Kathrein receivers into home network; IEEE 802.11n; WLAN hotspot. Thanks to option of setting up a WLAN hotspot, TV and radio broadcasts can also be transmitted to mobile devices (smartphones, tablets, etc.) without an additional Internet router. Simple installation via the receiver menu, no additional software required. Suitable for UFS 946/CI+, UFSconnect 906 and CAP 650/750/850.

49094 43,60



Easy alignment thanks to extensive equipment

The "Precision" satellite antenna impresses with its easy handling and high functionality. Design of antenna is unique and finding the satellite is child's play thanks to built-in satellite finder, the precisely adjustable elevation and the south mark on leg of tripod. Simply align the marked leg to the south using the compass. The rotation limitation on the tripod only allows a search angle of approx. 30 degrees. The desired satellite is located in this segment.

Scope of delivery:

Satellite antenna w/ satellite tripod, integrated satellite finder, compass, universal LNB w/ low noise figure, transport bag for tripod and satellite antenna, 10 m coax connection cable (w/o. receiver).

Maxview Precision 65 cm with Single LNB 496654 403,-

Maxview Precision I.D. 65 cm with Twin LNB Identical to Precision 65, but with satellite identification module. This allows the antenna to be aligned in a matter of seconds. The blue LED display confirms that you are on the satellite selected in the receiver.

496657 523,-



Portable Kit Light with tripod and bag

- Skew adjustment scale
- Universal LNB (retractable arm)
- With 54 cm or 65 cm satellite mirror

Complete satellite package from Maxview includes everything you need for reception: elliptically shaped satellite mirror (54 cm or 64 cm), satellite tripod, compass, satellite finder, coax cable w/ F-connectors & a practical carrying bag. All you need is a TV set and a receiver or a TV with an integrated satellite receiver. High stability. Universal, rotatable pole mount. Precise degree graduation and skew adjustment scale facilitate alignment. Universal LNB specially tuned. Only 4.5 kg light. Scope of delivery: Mirror, aluminum tripod, satellite finder, LNB, satellite compass, connection cable, carrying bag.

65 cm mirror 49765 261,-





Cable routing due to aluminum base

Matching adhesive set on page 950.

Active DVB-T2 omnidirectional antenna

- Intended for mounting on the vehicle roof
- Integrated amplifier
- Concealed cable routing (through antenna base)

Antenna with the latest SMD technology. Excellent reception of digital terrestrial TV (DVB-T) and radio programs (DAB radio). Reception of local/regional FM radio signals. With built-in amplifier. Extremely wide frequency range. Weatherproof, rustproof, design with aluminum base.

Technical data:

Frequency ranges: FM 87.5-108 MHz, VHF 174-230 MHz, UHF 470-862 MHz, aperture angle: vertical 90°/horizontal 360°, output level: max. 108 dB V, gain: 35 dB, input voltage: DC12/24 V, operating voltage: 5 V DC, connection: F-connector. Dims.: Ø base: 13 cm, Ø antenna: 30 cm, total height: 20 cm

49410 120,-



Digital terrestrial 360° DVB-T2 antenna Wing 11

The Wing 11 antenna series was developed for the reception of terrestrial digital signals. Aerodynamic shape for low air resistance. Special base for tilting the antenna in any direction. For mounting on the roofs of motorhomes, caravans or yachts. Special antenna design enables reception of TV programmes even in the low frequency range (VHF-B3). With LTE/4G filter against interference.

Technical data Wing 11:

Gain: CH 5 - 12: 16 dB, CH 21 - 60: 26 dB, power supply: 12/24 V, diameter: 38 cm, height: 16.5 cm, weight: 1.2 kg.

Scope of delivery: 1 antenna w/ 5 m coaxial cable & 3 F connectors, 1 amplifier w/ adjustable gain & 3 outputs for TV + 1 radio output DAB & FM.

491940 286,-



Active VHF/UHF DVB-T2 antenna for indoor and outdoor use

- For receiving digital terrestrial DVB-T programs
- Reception range VHF: 174 - 230 MHz, UHF: 470 - 862 MHz
- Horizontal and vertical polarization
- Gain B III: 18 dB; UHF: 15 dB

① DVB-T2 outdoor antenna BZD 40

Horizontal and vertical polarization. Extremely low noise figure. Connection with F socket and weather protection cap. Remote power supply (5 V/30 mA) via coaxial cable through the connected DVB-T2 receiver or with external remote power supply unit (2-25 V).

Mounting for wall and floor. 10 m connection cable. F and ICE plug. Instructions. Dims.: 25 x 7.5 cm. Weight: 1.1 kg

49438 120,-

② DVB-T2 indoor antenna BZD 32

Active VHF/UHF antenna w/ integrated amplifier for receiving digital terrestrial TV & radio programs (DVB-T/-T2).

Remote power (5 V/30 mA) is supplied via USB remote power cable, e.g. from TV set.

Connection: IEC socket, Integrated blocking filter against GSM & LTE interference. Dims.: 14 x 19.5 cm. Weight: 0.5 kg

49105 72,-



1-cable connection

Snipe Cell phone

Portable Satellite antenna incl. theft protection

- Perfect for mobile use: antenna can be placed anywhere with a clear view of satellite
- Single LNB, 4 satellites pre-programmed (Astra1, Astra2, Hotbird, Eutelsat 5W)
- 1-cable solution: Receiver connection & power supply to antenna via 1 coaxial cable
- Integrated theft protection (optical & acoustic)

1-cable connection: Connection of antenna to controller incl. power transmission via 1 coaxial cable. Metal eyelet for attaching a steel cable (not included) to prevent theft. In addition, acoustic warning signal in case of non-permitted removal of the coaxial cable. Robust plastic cover provides best possible protection against the weather.

Satellite search time: app. 180 sec., power consumption: 30W. Signal amplification: 31 dBi, Reception power: 51 dBW, Search angle: 15° - 90°/360°, App. dims.: Ø 450mm, H 390 mm. Scope of delivery: Antenna incl. remote control, controller w/ holder & power cable w/ cigarette lighter plug, 10m coaxial cable, operating instructions. Weight: 7.6 kg.

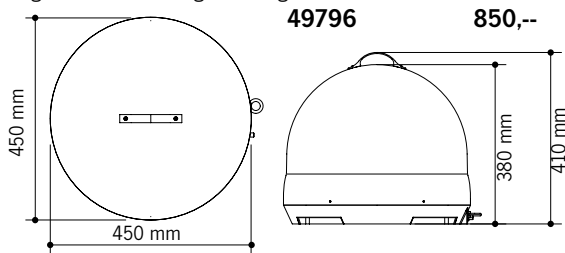

- 12V / 24V
- SINGLE LNB
- 4 SATELLITE PRE-PROGRAMMED
- 1-CABLE CONNECTION
- WITH THEFT-SECURITY

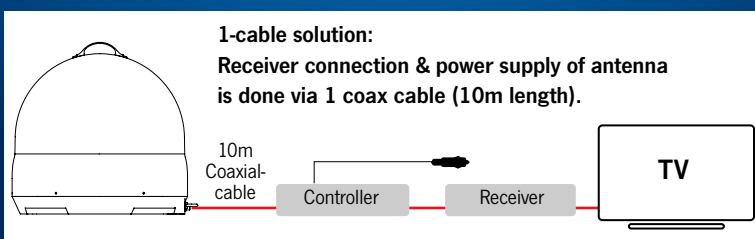
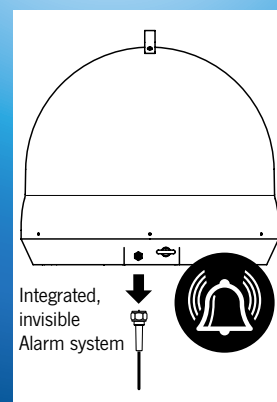
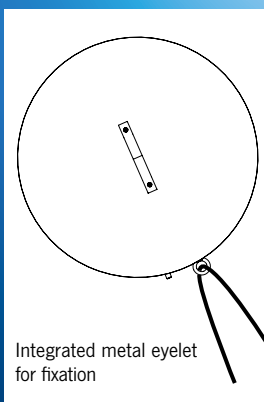

Portable satellite antenna with automatic alignment - also for fixed mounting!

- With Twin LNB
- Receiver independent
- Fully automatic satellite search in 60-90 sec.
- No assembly necessary: Set up, search for satellite, done

Lightweight and portable. With 2 receiver connections. Dynamic leveling, compensates for unevenness. Dimensions H46 x L42 cm. Weight 4.5 kg

VuQube Auto 2 w/ automatic satellite search.

Scope of delivery: Antenna, control unit, 1x10m cable, instructions.

- ① VuQube Auto 2 496555 1166,--
- ② Roof mounting kit 496556 49,--
- ③ Tripod for VuQube antenna made of aluminum
Dims. unfolded: H85 x W120 cm, dims. folded: H80 x W17 cm
Weight: 1890g 496558 119,--
- ④ VuQube padded transport bag for safe storage 496557 62,10



PORTABLE DOME ANTENNAS

No external Power source required

Optionally with 5 pre-programmed satellites

Also available in graphite

MEGASÄT

NACHHALTIGES PRODUKT

MEGASÄT forstet auf
Pro verkauftem Campingman Portable Eco pflanzt Megasat einen Baum in der Rhön.

Technical data:
LNB type: Universal LNB, Frequency band: Ku-band, Input frequency range: 10.7 - 12.75 GHz, Polarization: V/H, Signal gain: 31 dBi at 12.7 GHz, Minimum EIRP (footprint): 51 dBW, Elevation (tilt): 23° - 43°, Azimuth (rotation): 360°, 1.5-axis DC motor, Control unit w/ Bluetooth module, Temp. range: -20°C - +70°C, Power supply: DC 12 Volt, Mirror size: 380 (Ø)

MEGASÄT

Brillantes Fernsehen

Campingman Portable ECO - the energy saver

- Parabolic antenna with universal LNB
- No separate control unit required
- The plastic cover provides the best possible protection against weathering and damage
- No more updates required for transponder changes
- Can be set up in any location (e.g. floor, roof, table...)

Antenna does not require a separate control unit. The coaxial cable is connected directly to TV or receiver. Antenna is also supplied w/ power from there. All you have to do is switch on your TV or receiver & the antenna will automatically search for satellite (pre-programmed for Astra 1). The antenna is suitable for 1 subscriber. Dims. Ø 450 mm x H 430 mm. Weight 4.2 kg. Scope of delivery: Campingman Portable (ECO/ECO Graphite/ECO Multi Sat), coaxial cable, operating instructions

Campingman Portable ECO	492940	871,-
Campingman Portable ECO Graphite	492950	904,-
Campingman Portable ECO Multi Sat incl. Bluetooth remote control and 5 pre-programmed satellites	492951	980,-

Illumination zone **Astra 1**

Connection example

Coaxial cable

Television

KATHREIN

Technical data: Supply voltage LNB: 13-18V, Input frequency range: 10.7 GHz - 12.75 GHz, Output frequency: 950-2150 MHz, Signal gain: 31 dBi at 11.7 GHz, Minimum EIRP: 51 dBW, Power consumption max.: 5.4W, Dims. (Ø x H): 450 x 440mm. Weight: 4,5kg

KATHREIN

CAP 500M plus

- Fully automatic and portable SAT system
- incl. CAP converter V2 and WLAN USB stick
- TV becomes simpler, more portable & more flexible

Fully automatic, portable camping satellite system for Astra 19.2° East including CAP converter V2 and WLAN USB stick UFZ 131 for live TV/radio streaming to mobile devices in conjunction w/ free CAPcontrol app (iOS & Android). The CAP 500M Plus complete package makes camping TV simple, portable & therefore mobile & flexible. Watch your favorite TV programs on your TV or even on your smartphone/tablet using the free CAPcontrol app.

49644 **1253,-**

KATHREIN

Technical data: Supply voltage LNB: 13-18V, Input frequency range: 10.7 GHz - 12.75 GHz, Output frequency: 950-2150 MHz, Signal gain: 31 dBi at 11.7 GHz, Minimum EIRP: 51 dBW, Power consumption max.: 5.4W, Dims. (Ø x H): 450 x 440mm. Weight: 4,5kg

KATHREIN

CAP 500

- Quick installation & TV reception in 90 sec.
- No additional control unit, receiver or separate power supply required

Fully automatic, portable camping SAT system for Astra 19.2° East. No additional control unit, receiver or separate power supply required - antenna is connected directly to existing TV set or SAT receiver w/ a single cable.

49645 **1035,-**

ROAM Internet antenna

- Internal reception while driving & when stationary
- Router incl. wall mount receives 3G/4G & WiFi signals
- For up to 50 end devices/users
- Hotspot function for your own home network
- Unlocked for every SIM card
- Roof mounting available as an accessory



With app control

MAXVIEW ROAM

Powerful mobile internet antenna, designed to receive a maximum 3G/4G/5G signal. In conjunction with the LTE router, a secure and reliable hotspot is created in your vehicle. The supplied router is able to receive 3G/4G and WiFi signals; it is set to LTE reception on delivery. (but can be switched to WiFi reception if required)

① **Technical data WiFi omnidirectional antenna for motorhomes :**
Omnidirectional antenna MIMO, frequency: 698MHz to 6000MHz, gain: 5.9 - 8.8 dBi, cable length: 0.8m, material: aluminum base plate, UV-stable ASA cover, dims.: Ø 196 mm, height: 65 mm, weight 386 g.

② **Technical data WiFi antenna for panel van:**
Omnidirectional antenna MIMO, frequency: 698MHz to 6000MHz, gain: 5.9 - 8.8 dBi, cable length: 0.8m, material: aluminum base plate, UV-stable ASA cover, dims.: HxWxD: 65x180x60 mm, weight 500 g.

Technical data router:
Router type: LTE & WiFi, speed: up to 150 Mbps, max. connection: up to 50 devices. Voltage: 12 V, power consumption: <5W, SIM card: freely selectable. Dims.: HxWxD 83 x 74 x 25 mm, weight: 125 g

Scope of delivery: Roam LTE antenna, LTE/WiFi router, 12 V connector plug, 230 V, mains adapter, router wall mount, 2 m cable with SMA connectors, instructions.

- ① WiFi omnidirectional antenna white for motorhomes 49637 544,-
- ② WiFi antenna white for panel van 49856 544,-
- ③ WiFi antenna black for panel van 49857 544,-

④ **Roof bracket incl. 3m cable and roof bushing:**
(If there is no possibility to lead cables directly underneath antenna into vehicle)

- White aluminum roof bracket for motorhomes 49764 70,80
- White aluminum roof bracket for panel van 49860 70,80
- Black aluminum roof bracket for panel van 49861 70,80



For motorhomes



For panel vans



5G
READY ANTENNA

Further information at www.reimo.com



④ Roof bracket set

Camper Connected LTE WiFi system

- Reception of LTE and WiFi signals
- Powerful 3G and 4G router
- Amplification of signals into vehicle interior
- Compact design

The Camper Connected LTE WiFi system combines a powerful outdoor unit with a powerful router. To ensure interference-free Internet reception, the radio signal is amplified into the vehicle interior in the usual WLAN quality.

Technical data antenna: 3G/4G WiFi reception, frequency: 698 MHz to 960 MHz/1710-2170 MHz/2500-2700 MHz. Gain: 2-5 dBi, Max. Power: 50 W. Cable length: 3 m. Dims.: Ø 190 mm, height: 120 mm. Weight: approx. 860 g.

Technical data router: Router type: LTE and WiFi, Speed: at 2.4G up to 300 Mbps, Max. Throughput current: 500 mA. SIM card freely selectable. 4x LAN port, 1x USB 2.0 interface, 1x micro SD card slot, dimensions: WxHxD 130x85x30 mm, weight: 325 g

Scope of delivery: outdoor antenna, 2 connection cables for antenna/router (3 m), mounting plate, roof feed-through, router incl. 12V power supply unit, 12V car connection cable, instructions.

- 49116 326,-

MEGASAT
Brillantes Fernsehen





Oyster[®] CONNECT VISION

Mobile Internet like at home, even while driving

- Powerful WLAN and LTE antenna (4G)
- One-off & simple setup of "mobile home network"
- Free selection of 2.4 GHz / 5 GHz in WLAN network for both indoor unit and outdoor unit
- For all LTE bands from 698 MHz to 3800 MHz
- Mounting the transmitter and receiver unit on top of the vehicle roof
- Aerodynamic, space-saving design
- No attenuation loss due to data cable

With Oyster[®] Connect antenna system, you always have your Internet connection w/ you. You can surf in your motorhome, camper van or caravan in complete relaxation - and also enjoy all benefits of a "mobile home network". The mobile hotspot ensures a stable signal - even while driving. Connection is maintained regardless of location, regardless of which network the external signal comes from - registered end devices automatically connect to their own hotspot.

Dims.: LxWxH 405x292x120 mm, weight: 1.5 kg.
Scope of delivery: Oyster[®] Connect Vision antenna, indoor unit, roof feed-through with 4 m data cable, power connection cable, mounting plate.

LTE
Access to the public mobile network

WIFI
Access to the public WLAN network

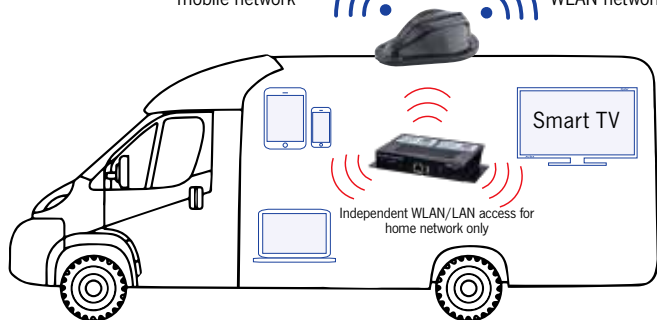

	Item no.	Price
Oyster [®] Connect Vision	49035	1085,-

Combine Oyster[®] Connect Vision antenna with Oyster[®] Smart TV of your choice:

Oyster[®] ACCESS

Oyster[®] Access outdoor antenna

- Full-size antenna with separate roof feed-through for antenna cables
- 2x LTE all-band antenna with Diversity technology
- 4x WLAN antenna for 2.4 GHz and 5 GHz MIMO
- 4x high quality antenna cable in protective sleeve, detachable on both sides, 2 meters
- Antenna dims.: Ø 30.5 cm x 13.0 cm, mounting holeø 18-20 mm
- Incl. Router (see below for technical details)



Product	Item no.	Price
Oyster [®] Access Vision	490350	959,-



2 x sim card reader

Oyster[®] EASYNET

Oyster[®] EasyNet outdoor antenna

- Space-saving hemispherical outdoor antenna with integrated cable feed-through
- Compact antenna with 2x LTE and 2x WLAN MIMO
- 4x low-loss antenna cable, permanently connected on antenna side, 1.5 meters
- Thread length 27 or 45 mm available
- Antenna dimensions: Ø 11 cm x 5,5 cm, mounting holeø 28 mm
- Incl. Router (see below for technical details)



Product	Item no.	Price
Oyster [®] EasyNet V1 - 27 mm	490351	871,-
Oyster [®] EasyNet V1 - 45 mm	490352	871,-

Oyster[®] Access / Oyster EasyNet Router

- 2.4 GHz + 5 GHz dual-band WLAN for the private network
- LAN connection for the private network
- 2.4 / 5 GHz WLAN module for connection to an external WLAN via external antenna
- LTE module for use in the EMEA region
- Two SIM card readers
- Optional CI/LIN bus
- Optional CAN bus
- Temperature-controlled fan
- Login of up to 250 end devices possible
- Router dims.: 17.5 x 4 x 9.3 cm

tenHaaft
Innovative Mobile Technology

Oyster® Multimedia packages



Oyster® Multimedia - Package offer

Oyster Multimedia Package - Package consists of:
Satellite antenna Oyster® 70 Premium Base (catalog page 451)
Oyster® Smart TV 21.5" (catalog pg. 430)
Internet antenna Oyster® EasyNet V1 - 45 (catalog page 460)

493300 3116,--



Oyster® Multimedia - Package offer

Oyster Multimedia Package Pro - Package consists of:
Satellite antenna Oyster® V Premium Base Twin Skew (catalog page 452)
Oyster® Smart TV 24" (catalog page 430)
Internet antenna Oyster® Access (catalog page 460)

493301 4358,--



CAR 150 WiFi Duo camping router

- Two SIM card slots
- 12 V or 230 V power supply possible
- LTE antenna (4G)



Internet reception also available while driving and internationally. Use of existing WLANs, e.g. campsite/restaurants/hotspots MIMO outdoor antenna for perfect LTE/WLAN reception. Future-proof thanks to update option via the Internet. 12 V or 230 V power supply possible. 5 x antenna, 4 x Ethernet, 1 x USB connection and many other connections. Router dimensions WxH: 109x50 mm. Antenna dimensions Ø 110 x H 55 mm. Weight: 295g

Scope of delivery:

Roof antenna, 12 V connection cable, roof feed-through w/ fastening screw w/ knurled nut, network cable (1.5 m), 230 V-12 V power supply unit.

49130 599,--



KATHREIN



Camping router CAR 160 WiFi Duo 5G MIMO

- LTE/5G MIMO antenna (black or white)
- Two SIM card slots
- 12 V or 230 V power supply possible

The CAR 160 WiFi Duo 5G MIMO dual SIM WLAN router set enables the connection of mobile devices (cell phone, tablet, notebook) to the Internet via an existing WLAN or the mobile data of an inserted SIM card.

Technical data:

Connections: 2 x SMA for LTE, 2 x RP-SMA for WLAN, 1 x SMA for GPS, 3 x LAN, 1 x WAN, 1 x USB host; mobile radio standards: 4G/LTE (Cat. 4), 3G, 2G; Input voltage range: 9 - 30 V; Power consumption: 2 W; Router dims.: W109 x H50 x D103 mm. Antenna dimensions Ø 110 x H 55 mm. Weight: 295 g

Scope of delivery: Router, internal WLAN antenna, 230 V power supply unit, Ethernet cable 1.5 m, roof antenna, roof feed-through w/ fastening screw w/ knurled nut, 12 V connection cable, operating instructions

Car 160 Duo Black 49147 686,--
Car 160 Duo White 49148 686,--



KATHREIN

5G ANTENNA



MEGASAT
Brillantes Fernsehen

Camper Connected 5G (LTE and WiFi system) - Best Internet reception for all common mobile devices & smart TVs.

- LTE/5G + 2.4G / 5.8G WiFi + GPS + DAB antenna
- Gain: 2-5 dBi; Impedance: 50 dB
- Transmission rate 2.4 G to 300 Mbps and 5.8G to 867 Mbps
- GPS tacking to localize the vehicle
- 3x LAN connection, 1x WAN connection
- 1x USB 3.0 data interface
- 2x SIM card slot
- Encryption to protect your data
- Firewall security system
- Power consumption: 5 watts to max. 20 watts



980,-

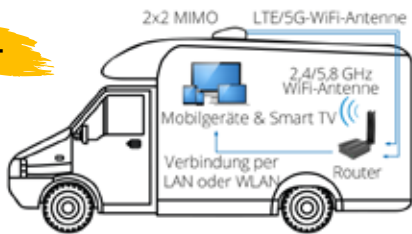

Megasat Camper Connected 5G WiFi system combines a powerful outdoor unit with an equally powerful CAT20 router. It increases the performance of the mobile phone signal to a maximum and ensures interference-free Internet reception.

With Camper Connected 5G, a radio signal is now amplified inside the vehicle, ensuring the best Internet reception in high Wi-Fi quality. The integrated GPS antenna allows you to call up the location of your vehicle at any time. The outdoor antenna also has a DAB+ antenna connection to provide the best reception for DAB+ devices.

497008

980,-

Technical data antenna:

LTE/5G + 2.4G / 5.8 G WiFi + GPS + DAB antenna, frequency range: LTE/5G: 614-960 MHz / 1710-2300 MHz / 2500-2700 MHz / 3300-4500MHz; WiFi: 2400-2599/5100-5900MHz; DAB:170-230 MHz; Gain: 2-5 dBi; Impedance: 50 dB, Omni-directional radiation pattern; Polarization: Linear Vertical, Max. power: 50 watts, Antenna cable: 4x RG316, 1x RG174 3 m, Connection: 4x SMA / Fakar, Removable mounting plate, Dims. (W/H/D) 252 x 215 x 95 mm, Weight: app. 750 g.

Technical data router:

LTE/5G WiFi router + 2.4/5.8GHz WLAN, GPS tacking for localizing the vehicle, CAT20 standard, 4x4 MIMO (Multiple Input Multiple Output) Enables optimum reception through simultaneous parallel connection with 2 or more antennas to mobile phone masts, 3x LAN connection, 1x WAN connection, 1x USB 3.0 interface, 8x antenna socket (SMA), 2x SIM card slot, up to 150

Scope of delivery:

- LTE 5G/WiFi 2.4/5.8G outdoor antenna
- Connection cable for antenna & router (3 m)
- Mounting plate and roof duct
- Router incl. antennas & 12 V power supply unit
- 12 V car connection cable
- Operating instructions

WiFi users, encryption to protect your data, firewall security system, support for international SIM cards (Auto APN), aluminum housing incl. bracket, power consumption: 5 watts to max. 20 watts.

Dims. (W/H/D) 124 x 44 x 113 mm, weight: app. 470 g.





alphatronics STREAM

The Internet solution for on the go!

- Ideal Internet solution for on the go
- Simple assembly
- Easy app operation
- Two SIM card slots
- Keep an eye on your data consumption
- Perfect addition for your alphatronics Smart-TV
- Power supply via 12V connection cable / 230V power supply unit

alphatronics STREAM is your mobile router that allows you to flexibly use the mobile Internet with all your devices (smartphone, tablet, laptop and smart TV) while on the go.

Benefit from the powerful combination of 4 antennas, an automotive-certified router & the alphatronics web app for easy setup, operation & management of your personal networks. The ideal WiFi solution for motorhomes, camper vans & caravans!

Supported by Teltonika

All routers are manufactured in Europe, meaning that any necessary software updates can be carried out quickly and easily.

Factory-unlocked for each SIM card

The router is designed to work with almost any data service provider. You can choose between Pay As You Go or a monthly contract so that you can use any network that suits your needs Requirements.

Safe surfing on the Internet

Advanced password encryption methods are used to ensure a secure Internet connection.

Connectivity

The router can be connected directly to a Smart TV device with an Ethernet cable for an even faster connection.

Family-friendly surfing

Customized website blacklist filters can be set up to block unwanted web pages.

Scope of delivery Stream:



Scope of delivery Stream2:



User devices

Connect up to 50, 100 or 150 devices simultaneously (depending on model) including smart TVs, smartphones, tablets & laptops. Free app!

Incl. Wall bracket for the router

Specially designed, unique router wall bracket for a clean and secure installation.

Power supply

12 V via the supplied 12 V connection cable with switchable plug or alternatively with an optionally available 230 V power supply unit.

Ethernet ports

RJ45 (WAN and LAN).

WiFi sources that require a connection via a captive portal are not supported.

Scope of delivery: LTE/WiFi router, roof antenna (PUCK), 2x LTE antennas w/ magnetic base, 2x WIFI antennas w/ magnetic base, 1x GPS antenna, 12V power cable w/ cigarette lighter, 230V power supply unit, LAN cable, mounting accessories.

Product overview	Stream	Stream2
Suitable for	Standard user (up to 3 devices at same time)	Mobile office or family (up to 5 devices at the same time)
Speed (Download)	up to 150 Mbit/s	up to 300 Mbit/s
Standard	CAT4	CAT6
Number of SIM slots	4G, 3G, 2G	4G, 3G, 2G
Mobile networks	2x	2x
Automatic SIM configuration	Yes	Yes
SIM slot circuit	SIM1 or SIM2	SIM1 or SIM2
Use in	Europe, Middle East, Africa	Europe, Middle East, Africa, Australia
Network speed	2.4 GHz	2.4 GHz / 5.0 GHz
LAN connections	4x	4x
Item number	497018	497019
Price	544,-	752,-

HDSTICKS/SATRECEIVER/SAT FINDER

MEGASAT
Brilliantes Fernsehen



HD Stick 310 V3

- Razor sharp with Full HD resolution
- Picture formats: 4:3, 16:9
- 2 USB ports
- Hidden installation behind the TV

HD satellite receiver (DVB-S2) suitable for concealed installation behind the TV. Infrared sensor with integrated display. Reception of all free HD programs. Incl. 2 USB ports for media playback. 7 days EPG.

496272 65,30

MEGASAT
Brilliantes Fernsehen

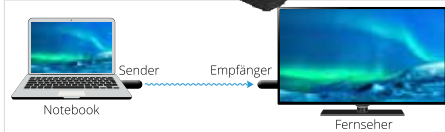

HDMI Extender Mini II

- Wireless transmission of HDMI signals in Full HD (up to 30 mtrs.), e.g. from notebook to TV
- Transmitter supports up to two receivers
- Perfect solution for meetings, conferences & home entertainment

Resolution up to 1080 pixels. Expandable with a second receiver (1 to 2).

Scope of delivery: 1x transmitter, 1x receiver, 2x USB to micro-USB cable (length: 100 cm), 2x HDMI extension (length: 17 cm), operating instr.

496271 164,-

MEGASAT
Brilliantes Fernsehen



Receiver HD 390

- Resolution of up to 1080 pixels
- 2 USB ports (front and rear)
- Digital coaxial audio output
- Energy saver in operation and standby

To watch TV programs in best quality, a detailed picture reproduction with full HD resolution of up to 1080 pixels is provided. The usual simple operation of the Megasat receivers also proves itself with this model. The two USB ports allow easy playback of image and music files.

Scope of delivery: megasat HD 390, remote control, batteries, 230/12 volt mains adapter, operating instr.

496200 32,60

MEGASAT
Brilliantes Fernsehen



SAT-Finder SF-200

Acoustic and visual signal display for aligning the satellite system. With integrated backlight, ideal for use in the dark. In addition, the Satfinder offers an attenuation control which can be used for optimum fine adjustment. 13-18 V DC supply voltage via the receiver.

492010 10,80

MEGASAT
Brilliantes Fernsehen



SAT-Finder SF-210

Digital signal display for aligning the satellite system. The integrated backlighting of the display also enables adjustment in the dark. The satellite finder's additional attenuation control allows for optimum fine adjustment. With the buzzer function, an acoustic signal sounds as soon as you approach a satellite.

492012 21,70

MAXVIEW
HOME ENTERTAINMENT ON THE MOVE



SAT finder

For quick and precise alignment of satellite antennas. The satellite finder is simply connected between receiver and satellite antenna. The approach to the satellite is indicated visually and acoustically by the LED display. The sensitivity control can be used to adjust the sensitivity to different reception levels.

49264 31,60



KATHREIN



F-connection external socket outlet

Outdoor socket outlet w/ F plug connection. 5 m coaxial cable. **49108 38,10**

Outdoor sockets

F connection

Outdoor socket outlet, 1x F plug socket incl. 3 m cable.
Color white **49266 33,90**
Color anthracite **492662 38,10**

Twin F connection

Twin outdoor socket outlet for operating 2 antennas. 2x F-plug-socket incl. 3 m cable. Color white **49763 41,20**

F connection with coax socket

Twin outdoor socket outlet for operating 2 receivers or as an indoor/outdoor socket outlet. 1 F plug and 1 coax socket incl. 3 m cable. Color white **49267 42,-**

Coax socket

Outdoor socket outlet w/ 1 coax socket incl. 3 m cable. Color white **49760 33,90**

MAXVIEW
HOME ENTERTAINMENT ON THE MOVE



Fig. shows Twin F socket



Satellite end socket

W/ 3 connections, connection attenuation 1 dB, with surface-mounted housing. **492864 14,20**
492864L



12V aerial socket

12 V cigarette lighter/TV/Sat, 1 pc. SB, slate (dark gray) or brown
Slate **491102 16,50**
491102L
Brown **491100 17,40**
491100L



12V standard aerial socket

12 V standard/TV/Sat, 1 pc
Grey **49109 16,30**
49109L
Brown **491090 16,30**
491090L

2
PIECE

Single and double frame for 12V socket

Single frame, 2 pieces

Grey **820751L 820751 2,75**
Slate (dark gray) **820752L 820752 2,75**
Brown **8207501L 8207501 2,75**

3Double frame, 1 piece

Grey **82074L 82074 3,25**
Slate (dark gray) **820742L 820742 3,25**
Brown **820740L 820740 3,25**

Roof ducts

- ① **Roof duct HDZ 100**
for holding a max. of 3 cables up to Ø 7 mm. Roof duct Ø 38 mm. Dims.: 211 x 90 x 37 mm **491922 32,60**
- ② **Cable entry box**
A maximum of 3 solar modules can be connected watertight in conjunction with connection cable (85071). Roof duct: Ø 28 mm, max. roof thickness 60 mm. **85072 30,90**



Professional maritime cable ducts for camping vehicles and boats

- Extremely high-quality maritime design (seawater-resistant)
- Split seal, therefore problem-free plug feed-through
- Protection class IP 68 (waterproof, dustproof)

SCANSTRUT
outdoor technologies

	Wide Ø in mm	Opening max. Ø in mm	Height mm	Cable Ø in mm	Material	Item no.	Price
① DS-H6	30	N/A	17,0	2 - 6	Plastic	85241	27,30
② DS16	39	16	19,0	2 - 8	Kst. gray	85140	32,70
③ DS16	39	16	19,0	2 - 8	Kst. black.	85257	32,70
④ DS16	39	16	19,0	2 - 8	Stainless steel	85160	62,20
⑤ DS-H10	43	10	28	6 - 10	Kst. gray	851405	38,20
⑥ DS-H10	43	10	28	6 - 10	Kst. black.	85258	38,20



CARBEST
INNOVATIONS FOR MOBILE LIFE



Cable bushings

Safe passage of cables through roof and wall. For gluing on with Sikaflex, incl. cable gland PG 13.5 for cable Ø of 6-12 mm.

- ① White, single (app. L13 x D9.8 x H5.8 cm) **85049 12,-**
- ② Black, single (app. L13 x D9.8 x H5.8 cm) **850493 12,-**
- ③ White, 2-fold (app. L12.4 x D9.3 x H3.8 cm) **850491 14,20**
- ④ Black, 2-fold (app. L12.4 x D9.3 x H3.8 cm) **850494 14,20**

REIMO TOP PRICE 12,-

i Further cable bushings in the electrical sector under Solar

INDEX MARINE

	Wide Ø in mm	Opening max. Ø in mm	Height mm	Cable Ø in mm	Material	Item no.	Price
⑦ DG8P	35	10	12	2,5 - 6	Plastic	85192	12,-
⑧ DG21P	49	25	19	4,5 - 9	Plastic	85194	25,10
⑨ SE1P	~ 50 x 70	8	-	2 - 8	Plastic	85200	17,40
⑨ SE6P	~ 55 x 75	12	-	10 - 12	Plastic	85201	24,60
⑩ DK2	~ 63 x 82	6	-	2x3x6	Plastic	85202	28,30

ANTENNA MAST/SAT TRIPOD



Telescopic antenna mast for TV antennas

- Allows easy adjustment of the antenna without leaving the vehicle
- Suitable for motorhomes and caravans
- Reliably protected from water ingress
- Made from high-quality aluminum

① Antenna mast 50 cm

Total length: 50 cm, Ø 30 mm. Anodized and corrosion-resistant aluminum. Double O-ring-System reliably protects against water ingress
Weight: app. 0.5 kg. **492410 58,80**

② Antenna mast 150 cm

Total length: 150 cm, Ø 30 mm. Anodized and corrosion-resistant aluminum. Double O-ring-System reliably protects against water ingress
Weight: app. 1.1 kg. **492411 87,10**



Articulated satellite mast/ conversion articulated mast

- High ease of use thanks to swivel & tilting option
- With two retracted connection cables & four F plugs
- Poles made of aluminum, rod ends made of die-cast aluminum
- Max. Driving speed 130 km/h w/ antenna folded in

① HDM 140

• For mounting the BAS 60/66 flat antenna on the caravan or motorhome, length: 103 cm **49215 261,-**

② HDM 141

• Shortened version for mounting the BAS 60/66 flat antenna on caravan or motorhome, length: 76.5 cm **49216 261,-**

③ HDM 143

• For conversion from a terrestrial reception antenna, e.g. HD 35, to the BAS 60/66 Skew flat antenna
• Roof lead-through bracket can still be used **49219 239,-**



Easy alignment thanks to integrated bubble level.



HOME ENTERTAINMENT ON THE MOVE



Ideal for high hedges & fences

Universal SAT tripod- sand floor mounts

- Integrated "water trolley function"
- Correct alignment with the satellite
- Also with height-adjustable mast

Maxview Sat tripod "Classic"

Sat tripod, ultra-light, long feet for a secure stand. The best reception location for satellite reception.

① "Classic" aluminum sat tripod

3-legged, ultra-light. Fastening with tent pegs.

For mirrors with universal pole mount up to 90 cm, telescopic 94 - 101 cm Pack size 81 x 13 cm. Weight 1.35 kg. Tube Ø 34 mm **492400 70,60**

② Sat tripod "De Luxe"

as "Classic", but telescopic from 120 - 170 cm, tube Ø 34 mm, pack size 102 x 15 cm, weight 1.7 kg. **492690 95,30**

③ Lawn spike (ground holder)

Attachment of antenna, umbrella or rotary dryer. Galvanized, length: 50 cm. **90314 8,70**

Outdoor sockets



Empty box

Empty box with closed rear panel & magnetic closure, dims.: 130 x 145 mm, gray **820382 26,90**

Multifunctional outdoor socket outlet for 12V/230V

2xTV-Sat. Magnetic closure against unintentional opening. Dims.: 130 x 145 mm.

White	820392	63,90
Grey	820393	63,90
Light gray	820394	63,90
Black	820395	63,90

Replacement lid

Black	65232D	24,50
Light gray	65234D	24,50
White	65233D	24,50
Grey	65235D	24,50

Multifunctional external socket outlet

for 12 V / 230 V, antenna / TV Sat, dims.: 100 x 100 mm
Silver gray **820171 39,20**
Spare lid gray **820176 10,60**



Window feed-through
Slim Line window passage-cable guide for satellite connection cable(F plug) is shielded.
492859 6,90
492859L



F-angle plug
For kink-free bending of cables, 2 pieces SB.
492611 3,25
492611L



F-IEC adapter
① Adapter F plug to IEC socket
492875 3,25
492875L
② Adapter F socket to IEC socket
492874 3,25
492874L



F-connector
For connecting two F plugs n, 1 piece SB.
49265 3,20



F-connector
For coaxial cable, 2 pieces
Ø4,4 mm 492865 3,25
492865L
Ø5,0 mm 492866 3,25
492866L
Ø6,5 mm 492867 3,25
Ø6,9 mm 49261 4,65
492861L



IEC right-angle plug
① Coaxial angle plug
1 piece, white
492621 2,-



② Coaxial angle bushing
1 piece, white
492631 2,-
492631L



Digital coaxial cable
Shielding rating >100 dB, inner conductor CU, 75 Ohm, jacket 7.3 mm PVC.
100 m 492858 69,30



IEC TV cable, 1.5 m
IEC plug to IEC coupling. Connection cable antenna socket to TV/radio.
492872 4,35
492872L



Sat connection cable
10 m. With permanently mounted F plug on both sides.
492860 13,10
492860L

MEGASAT
Brillantes Fernsehen



Flexible coaxial cable Flex
Cable with nickel-plated F-connectors, 75 Ohm, Ø 6 mm.

1,5 m	492681	7,55
3 m	492682	8,65
5 m	492683	10,40
10 m	492684	15,20
20 m	492685	23,50



Coaxial plug
DIN 45325, inner conductor clamped. BZT approval white, 1 piece
49262 2,15
49262L



Sealing tape
Self-welding, for sealing plugs, connections, soldered joints, etc.
10 m 492856 17,40
80 cm 492857 2,95



Sealing grommet / gel sealing sleeve
For optimum weather protection at LNB connection. Sealing grommet for F plug, 1 pc. 492880 1,65
Cuff filled with flexible sealing gel. 1 pc. 492876 6,-
492876L





Cable retraction strap
Facilitates pulling into cable ducts, e.g. L: 15 m, Ø 4 mm, 15 mm
492855 32,70



USB cable, 1.8 m
For connecting e.g. printers, cameras, receivers and much more.
492871 3,25



HDMI cable
Gold-plated plug 1,5 m 492870 6,50
492870L
3 m 492879 8,65
5 m 494784 12,-
7 m 494785 16,30
Angled plug 2 m 494783 16,30



2-fold distributor
Also suitable for single-cable systems such as DPA 31 & DPA 51 as well as Unicable systems. 10 dB attenuation, DC pass-through (for SAT).
492873 10,90



Wire stripper
Easy stripping of all common coaxial cables.
492854 9,75
492854L



Mast cap
With cable gland for 12 cables . For pipes with 38 - 50 mm pipe diameter.
492851 20,20

REAR-VIEW MIRROR WITH INTEGRATED MONITOR



Compatible with all cameras on the right side



- 12 V
- TOUCH SCREEN
BUTTON CONTROL
- 
4.3" LCD
- RESOLUTION:
480 x 272
PIXEL
- 
ADJUSTABLE
GUIDE LINES
- 2 X
VIDEO
INPUT
- COMPATIBLE
SYSTEMS:
PAL/NTSC
- AUTOMATIC
ACTIVATION
WITH REVERSE
GEAR
- REMOTE
CONTROL
- E13
- E50



Universal holding clips

Including connection cable

Including connection cable

Rear-view mirror with integrated 4.3" monitor suitable for Fiat Ducato X290 mirror base



Rear-view mirror with integrated 4.3 inch monitor suitable for Fiat Ducato X290 mirror base, automatic activation with reverse gear, adjustable guide lines, 2 x video input, res.: 480 x 272, control via touch screen, remote control, video system: PAL/AUTO/NTSC, Emark certified, Dims.: app. 27 x 7.5 cm

47820

163,-

Rear-view mirror with integrated 4.3" monitor, universal clip-on mount

Universal rear-view mirror with integrated 4.3 inch monitor, clip-on version, automatic activation w/ reverse gear, adjustable guide lines, 2 x video input, res.: 480 x 272, control via touch screen, remote control, video system: PAL/AUTO/NTSC, Emark certified. Dimensions: app. 27 x 7.5 cm

47821

163,-

High-quality brake lights with integrated Reversing camera

- High-resolution cameras
- Plug & Play installation
- Night mode with night vision IR LEDs (except 47811 + 47813)
- 10m connection cable included
- All stop light cameras E9 certified



E9

Connection cable included w/ all brake light cameras

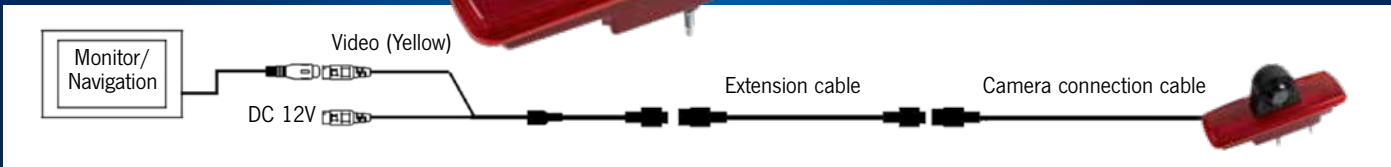

Model	① Fiat Ducato / Peugeot Boxer / Citroën Jumper and similar > 2006	② Volkswagen Caddy	③ Volkswagen Crafter > 2017	④ Volkswagen Transporter 6 > 2016 with large tailgate	⑤ Renault Trafic / Opel Vivaro > 2014
Camera system	1/3 CMOS	1/3 CMOS	1/3 CMOS	1/3 CMOS	1/3 CMOS
Resolution (HxV)	720x480 Pixel	960x576 Pixel	960x576 Pixel	960x576 Pixel	960x576 Pixel
TV system	PAL	PAL	PAL	PAL	PAL
Protection class	IP68	IP69	IP69	IP69	IP69
Viewpoint	160°	170°	170°	170°	170°
Horizontal resolution	600 TVL	700 TVL	700 TVL	700 TVL	700 TVL
IR LEDs	6 LEDs	-	9 LEDs	-	9 LEDs
Power supply	DC 12V	DC 12V	DC 12V	DC 12V	DC 12V
Operating temperature	from -20°C to +70°C	from -30°C to +70°C	from -30°C to +70°C	from -30°C to +70°C	from -30°C to +70°C
Energy consumption	< 3 W	< 3 W	< 3 W	< 3 W	< 3 W
Built in lens	2,6 mm	2,8 mm	2,8 mm	2,8 mm	2,8 mm
Emark certified	E9	E9	E9	E9	E9
Connection cable, length	10 m	10 m	10 m	10 m	10 m
Housing dimensions	app. 26 x 5,5 cm	app. 17,5 x 4 cm	app. 53 x 17,5 cm	app. 33.5 x 2.5 cm	app. 23,5 x 7,5 cm
Item number	47800	47811	47812	47813	47814
Price	196,-	54,50	196,-	141,-	152,-



Van View reversing infrared camera for panel vans with split rear door

Ideal for the vehicle roof edge, e.g. for panel vans and transporters with split rear door. Resolution: 500 x 582 pixels. 0 Lux, 9 night vision LEDs, viewing angle 120°, voltage: 12 Volt, temp. range: -20 to 70° C. Scope of delivery: Camera, 20 m connection cable, instructions & mounting material.

47803 130,-

E9



Radio transmission for Reversing systems

Reversing camera image can be transmitted wirelessly to a monitor via radio system. Installation is carried out without laying cables, thus reducing installation time. Operation via 12 V or 24 V possible. Radio range also suitable for larger motorhomes and caravans*. Digital 2.4 GHz radio transmission.

Scope of delivery:

1 receiver, 1 transmitter, incl. adapter for Carbest reversing systems.

47439 109,-

*Radio range max. 10 meters



①



① ZE-RCE3804 Rear view camera for Ford Transit

Reversing camera for Ford Transit, 7. Transit generation, from 2014, camera replaces the 3rd. Brake light, CCD sensor, viewing angle (dia.): 140°, mechanically adjustable camera angle, integrated microphone, night vision IR LEDs, 3-part 10 m system cable with screwed plugs

82212 217,-



②

② ZE-RVC80MT Universal camera

• Use as front/rear view camera

Die-cast aluminum housing, CMOS sensor, viewing angle (hor.): 140°, camera head can be swiveled vertically, concealed cable routing and fastening, 3 m + 6 m connection cable. 11 m cable optionally available

81544 174,-

③



③ Dual-sensor reversing camera for motorhomes ZE-RVSC200

- Compact and stylish reversing camera
- Cam1 sensor with 45° and Cam2 sensor with 100° horizontal viewing angle
- Image section manually adjustable
- IR-LED night lighting system for Cam2
- Integrated microphone (Cam2)
- Adaptation to pre-laid Dometic system cable w/ screw connection

48190 435,-



12 V wireless reversing camera systems with 7" monitor

- Color camera with night vision function
- Activation of the camera when reverse gear is engaged

Robust, waterproof 1/4" color camera. High-quality LCD monitor. Mounting the camera above or below the license plate frame. Activation when reverse gear is engaged. Wireless operation via transmitter.

Technical data:

Camera: 1/4" Color camera, 110° viewing angle, waterproof housing IP65, res.: 640 x 480 pixels. Night vision function: 6 IR LEDs switch on automatically at night.



7" display



Monitor: color LCD monitor, res.: 800 x 480 pixels. With audio and video function. AV input and integrated loudspeaker, mirror function. Attachment to the windshield. Connection to 12 V vehicle electrical system via cigarette lighter.

Scope of delivery: Transmitter, color camera, monitor w/ mounting base, connection cable, mounting accessories & 12 V power cable for the monitor. Radio transmission with 30 m range (free field). **47228 359,-**



Furrion Vision S Rear view camera incl. Side cameras and 5" or 7" Vision S monitor

- An display of up to four cameras
- Digital 2.4 GHz connection
- Up to 150m range
- Night vision mode and motion detection
- Incl. 2 side cameras

Up to four cameras can be displayed simultaneously on Lippert Vision S monitor. The camera is transmitted wirelessly up to 150 m via a digital 2.4 GHz connection. The night vision mode supports you in poorly lit parking situations. The reversing camera has motion detection and offers additional safety when parking.

The anti-glare 5" or 7" touchscreen monitor can be easily read from any angle. The 5" or 7" monitor can be conveniently attached to your windshield or stand.

Scope of delivery: Lippert Furrion Vision S 5" or 7" monitor, incl. rear view camera, 2x side cameras w/ LED warning light, suction cup for windshield and stand

Technical specifications: Vehicle type: Motorhomes, res. (pixels): 720x480px, Voltage in V: 8-30V

Lippert Furrion Vision S with 5" monitor 47823 675,-

Lippert Furrion Vision S with 7" monitor 47824 780,-



Side Camera with LED Marker Light



Vision S Monitor



Doorway/Rear Camera

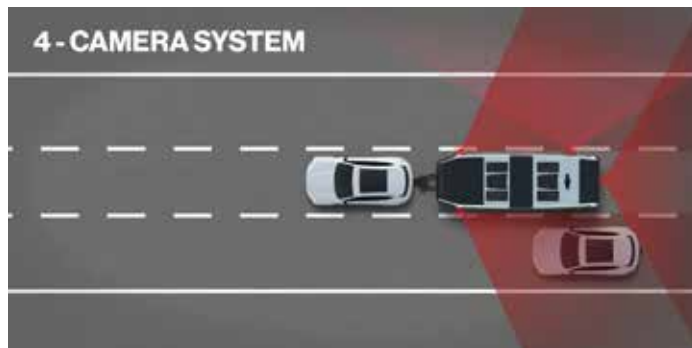



180° reversing function (LITE series)



Wide-angle view 180° (PRO series)



Reverse function 150° (PRO series)



View from above (PRO series)

Dynavision LITE series

- Cameras in LITE series offer a viewing angle of 180°
- Switchable auxiliary lines

Technical data LITE series:

Res.: 720x480 pixels, picture mode: NTSC, CMOS sensor: 1/3 CMOS, lens FOV: Horizontal 180°, vertical 90°, IP 67 waterproof.

- ① DVN CW 910 LITE, superstructure 47434 185,-
- ② DVN CW 920 LITE, Fiat Ducato 47436 185,-
- ③ DVN CW 930 LITE, replacement stop light for ex works installed Hella light 2DA343106-207 47438 185,-

Dynavision PRO series

- The PRO series cameras offer a rear-view mirror function with a viewing angle of 150° for permanent display
- Rear view camera (150°) with adjustable lines
- Wide-angle view with 180° viewing angle
- View from above for visual inspection when coupling a trailer
- The PRO series cameras can be controlled by touch via Dynavin radios. Other devices can be controlled by remote control.

Technical data PRO series:

Res.: 720x480 pixels, Picture mode: NTSC, CMOS sensor: 1/4 CMOS AR0140 from ON-Semi, ISP: GW4 from GEO-Semi, Lens FOV: Horizontal 210°, vertical 140°, IP 67 waterproof.

- ① DVN CW 910 PRO, superstructure 47435 392,-
- ② DVN CW 920 PRO, Fiat Ducato 47437 392,-
- ③ DVN CW 930 PRO, replacement stop light for ex works installed Hella light 2DA343106-207 47459 392,-

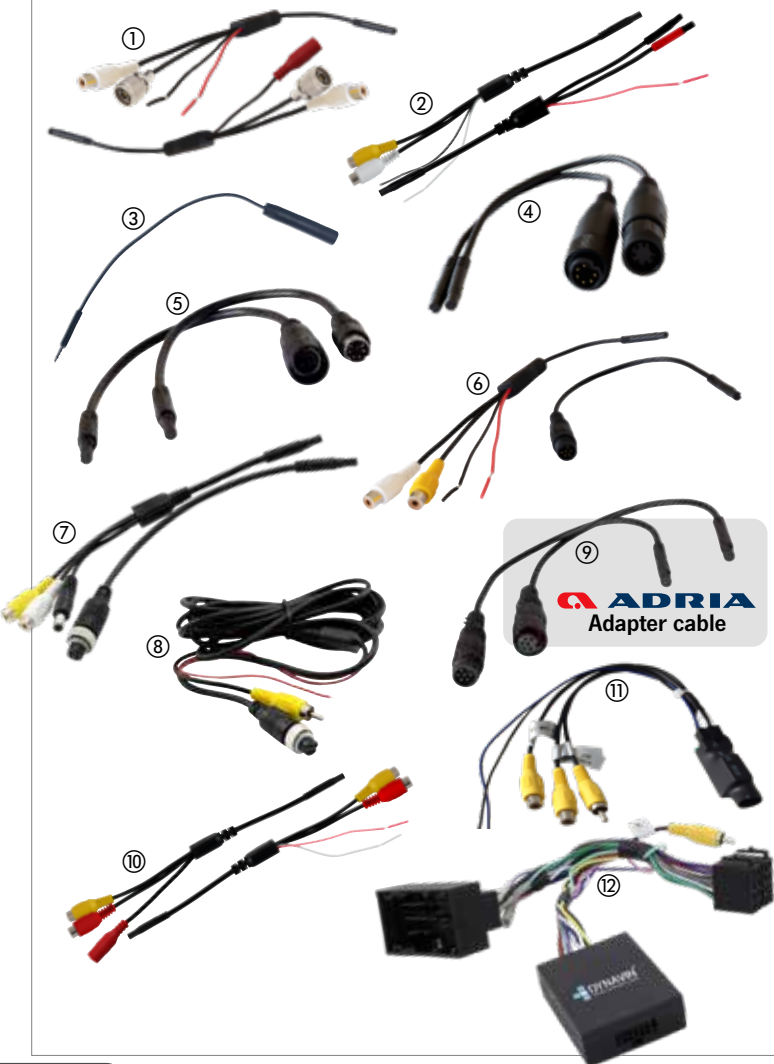

Adapter cable for connecting Dynavin cameras to pre-laid Camera cables of different Motorhome brands

- ① **Adapter cable Forster**
Camera adapter for e.g. Forster Ducato w/ BNC and cinch connection 47460 32,70
- ② **Adapter cable Sunlight / Carado**
Camera adapter for e.g. Sunlight and Carado 47461 32,70
- ③ **Zenec adapter cable**
Dynavision Lite camera adapter e.g. for connection to Zenec cable 47462 32,70
- ④ **Adapter cable Hymer / Bürstner**
Dynavision Waeco camera adapter for e.g. Hymer Group / Bürstner 47463 32,70
- ⑤ **Adapter cable Pössl, Hobby**
Dynavision Dometic camera adapter for e.g. Pössl 47464 32,70
- ⑥ **Adapter cable Knaus, Weinsberg**
Camera adapter for e.g. Knaus models 47465 32,70
- ⑦ **Adapter cable China**
Camera adapter for cables w/ China connection 47466 32,70
- ⑧ **Chausson / Challenger adapter cable**
Camera adapter for e.g. Chausson & Challenger 47467 32,70
- ⑨ **Adapter cable Adria / Camos cable**
Camera adapter for e.g. Adria & Camos cable 47468 32,70
- ⑩ **Laika adapter cable**
Camera adapter for e.g. Laika models 47469 32,70
- ⑪ **Adapter cable for reversing camera switching relay**
Adapter makes it possible to connect 2 cameras at the same time. If reverse gear is engaged, the VIDEO OUT connection has the signal from the reversing camera (R-CAM IN). If the reverse gear is left, the signal is forwarded to the second camera (e.g. to the front camera or 2. Camera as a mirror function). 47479 31,70
- ⑫ **CAN-BUS adapter for Fiat Ducato from YOC. 2014**
To operate the most important functions of a Dynavin radio via Steering wheel buttons, if available in the vehicle. For vehicles that are ex works were delivered with a Fiat radio. 47458 119,-

Blind spot camera system - incl. foldable monitor for Fiat Ducato, Peugeot Boxer & Citroën Jumper from YOC. 2006

- The set consists of front camera, 2 side cameras (for mounting on exterior mirrors) and folding monitor (DVN 6901 MO)
- The adjacent lane on both sides & overtaking cars directly next to your own vehicle become visible
- Front wheel and road visible all around when maneuvering
- No image distortion thanks to Software correction
- Installation w/o. calibration (nevertheless installation by specialist workshop recommended)
- **Rear view camera required** (Cameras can be found on pg. 458-462)
- **Also suitable for Fiat Ducato 8 (from 09/2021)**

Technical data Front camera & side cameras: Activation by setting blinker or engaging reverse gear. Res.: 720 x 480 pixels, Picture mode: NTSC, CMOS sensor: 1/4 CMOS AR0140 from ON-Semi, ISP: GW4 from GEO-Semi, Lens FOV: Horizontal 210°, Vertical 140°, IP67.

DVN 6901 LITE (Fiat Ducato panel van, semi-integrated)

47819 817,-

DVN 6901 LITE - V (Fiat Ducato fully integrated)

47822 817,-



Side cameras for 47819

Side cameras for 47822

Folding monitor for Fiat Ducato center console

- Rear-view mirror function while driving (if the camera makes this technically possible)
- Simple installation: The monitor is inserted into original Fiat Ducato center console
- Elegant solution that blends in perfectly with the original look of the vehicle
- The monitor is simply folded down when not in use
- For all Fiat Ducato models from 2006 onwards
- Also suitable for Fiat Ducato 8 (from 09/2021)

DVN 6901 MO

47815 326,-



Use e.g. as a rear-view mirror-Function while driving.



Fits perfectly into the Fiat Ducato Center console.



Use in parallel with the navigation system.





**7"/17.8 cm universal monitor for camera systems
ZE-MRV70**

- Very flat and attractive housing with easily adjustable, stable mounting base and clip-on sun visor
- 7"/17.8 cm TFT-LCD screen with 1024 x 600 pixel resolution
- High luminosity of 400 cd/m2 and optimum contrast ratio of 500:1
- Connection and control of up to 3 independent camera systems, with power supply
- Multinorm video system with support for PAL and NTSC-based camera signals
- Automatic reversing camera function, controlled via reversing signal (Reverse)
- Cam trigger signal inputs
- Image mirroring function
- Ceiling mounting possible
- Distance guides can be displayed separately for each camera image
- Automatic LCD TFT display day/night brightness control via LDR light sensor element
- Camera microphone input with adjustable volume & playback via integrated loudspeaker
- Simple operation via direct selection buttons on front of monitor & via separate IR remote control
- Operating voltage 12 V / 24 V
- Dims. (W x H x D): 180 x 120 x 17 mm (monitor)
- Monitor base, sun visor, 2 m main wiring harness with plug-in system connection & IR remote control incl. in scope of delivery



Maneuvering and parking large, heavy vehicles not only requires experience, but also the necessary overview. With the high-quality 7"/17.8 cm TFT LCD universal monitor ZE-MRV70 from ZENEC, you can keep an eye on everything at all times. Three cameras can be connected to the monitor (Cinch, CVBS), e.g. reversing, side or front cameras (PAL/NTSC).

The ZE-MRV70 impresses with its high resolution (1024 x 600 pixels) and brilliant image reproduction. The monitor can be activated automatically, manually or by remote control. All three camera images can also be switched on automatically via different triggers thanks to the trigger inputs. Auxiliary lines can be displayed separately for each camera for better distance estimation. Thanks to built-in loudspeaker, ZE-MRV70 can play back audio signals from a camera with microphone (CH1) - with adjustable volume.

The monitor has a practical stand with adhesive pad and is therefore easy to mount. The large contact surface ensures a secure hold. The stand can also be screwed down for suspended mounting, for example. The monitor can be flexibly rotated and tilted.

47826 261,-



↔ DOMETIC

Reversing cameras

① Brake light camera CAM 35 NAV CMOS camera with wide-angle lens integrated in a body-mounted brake light console (without. brake light). For Fiat Ducato X250, X290. Housing can be painted in vehicle color

CAM 35 NAV	473780	326,-
Remote view camera for retrofitting	473781	163,-

② Color ball camera CAM 18 NAV with housing for flexible alignment, normal or mirror image function, sturdy aluminum housing, freely adjustable ball camera, microphone, LDR-controlled IR LEDs

CAM 18 NAV Black	47373	359,-
CAM 18 NAV White	47377	337,-



Assembly made easy

The special reversing cameras are designed for Adria vehicles that already have a Camos connection cable. Also especially for the Fiat Ducato X250. The reversing camera is mounted with minimal installation effort and connected to the existing Camos cable.

Please order adapter cable for the existing Camos cable.

① Camos mini rear view camera CM-200M

1.3 megapixel, operating voltage 12-24V, heatable, with integrated microphone, waterproof (IP69K), viewing angle (H/V/D) 112/84/139, dims. incl. camera bracket (W x H x D) 51 x 46 x 54 mm

473905 217,-

Other adapters Camos and Dometic

② Camos adapter DRN-033A

For connecting a Camos camera to an AV cinch connection (e.g. for built-in moniceivers/naviceivers).

81731 38,10

Camos adapter DRN-031A

(not shown) For Adria from 2013, if cable available to AV cinch.

(e.g. for built-in moniceivers/naviceivers). **81730 38,10**

①



②



Complete reversing system SV-430

- Reversing system with CM-430 monitor and CM-36 camera
- Camera with infrared LEDs and microphone
- Integrated heating for a clear view

Reversing video system complete set with CM-430 monitor and CM-36 camera. The 4.3" monitor is compact and high-contrast with excellent picture quality. The digital display impresses with its high resolution and attractive design. Solid CM-36 color camera is equipped w/ infrared LEDs, a microphone & an integrated heater. The viewing angle of 125° makes maneuvering and reversing child's play.

Features of the components:

Digital 4.3" TFT LCD display, high res. 480x272, all functions in display (OSD), 5 languages selectable (DE, EN, FR, IT, ES), dims. (H)140x (W)83x (D)20 mm, 16:9 aspect ratio/contrast 700:1, brightness 400ccd/1 video input. Color camera: 700 TV lines, wide viewing angle 125°, IR LEDs, heating, microphone, CCD technology, stainless steel sun visor.

47358 359,-

CAMOS





What is the difference between a naviceiver and a moniceiver?

A moniceiver is the centerpiece of a complete multimedia system in the vehicle. It combines functions of radio, CD/DVD player, playback of external audio and video content (e.g. via smartphone or USB stick), hands-free system & sometimes also television. A Navireiver, on the other hand, supplements function of Monitainer w/ additional navigation system.



7"
Display



incl. remote control

Scan the QR code and get all the technical data on this product. (www.dynavin.de)



D8-DC7 Pro navigation system for Fiat Ducato 8 from YOC. 09/2021 and Fiat Ducato, Citroën Jumper and Peugeot Boxer from YOC. 2006

- Android 8.1 OS with 2 GB RAM & 288 GB ROM.
- High-quality 10,1"/16:9 LCD capacitive touchscreen display (res. 1027 x 600)
- Compatible with Apple CarPlay, Wireless Apple CarPlay, Android Auto & SmartPhone Mirroring
- Google Play Store pre-installed. Connection to Internet via integrated WLAN module
- Integration of CANBUS solution for steering wheel operation
- BT for audio streaming and hands-free calls via any smartphone (Android, Apple, etc.). External microphone included
- FM-RDS tuner with DSP noise masking and 15 preset stations, integrated DAB. Supports automatic switching between DAB and FM (seamless blending)
- Integrated sound DSP processor with 16-band EQ & time correction
- Multimedia player via USB port
- Rear view camera ready: Compatible with aftermarket rear view cameras
- Integrated GPS navigation (3 years of free map updates) with 3D view, online TMC and TTS
- The D8-DC7 Pro is also compatible with Fiat Ducato, Citroën Jumper & Peugeot Boxer from 2006 onwards in combination with 850380 mounting frame

Technical data:

SD card slot for navigation software, operation via 16:9 touch display, steering wheel connection or hands-free system. USB 2.0 connection, iPod connection via USB/iPod charging cable. Connection option for all Apple iPhones (from 3G). Media playback: Audio: APE/FLAC/M4A/MP3/WMA/WAV. Video: MPEG-4/AVI/FLV/MPEG/MPG/DAT/VOB/MKV.

Fiat Ducato 8 from 09/2021 850378 871,-

Mounting frame for installation in Fiat Ducato up to 08/2021, Citroën Jumper & Peugeot Boxer from 2006 onwards
850380 20,80



Dynavin motorhome navigation software incl.

Dynavin navigation systems include the iGO PRIMO Europe navigation software Truck version with camping & parking spaces. The software is stored on an 8GB MicroSD card, which is inserted into the card slot provided. The map material includes maps from 46 countries in Europe. 1 x free map update included.



D8-DCX2022 Pro navigation system for Fiat Ducato 8 from YOC. 09/2021 and Fiat Ducato,CitroënJumper and Peugeot Boxer from YOC. 2006

- Android 8.1 OS with 2 GB RAM & 288 GB ROM
- High-quality 10.1"/16:9 LCD capacitive touchscreen display (resolution 1280 x 720)
- Compatible w/ Apple CarPlay, Wireless Apple CarPlay, Android Auto & SmartPhone Mirroring
- Google Play Store pre-installed. Connection to Internet via integrated WLAN module
- Integration of CANBUS solution for steering wheel operation
- BT for audio streaming and hands-free calls via any smartphone (Android, Apple, etc.). External microphone included
- FM-RDS tuner with DSP noise masking and 15 preset stations, integrated DAB. Supports automatic switching between DAB and FM (seamless blending)
- Integrated sound DSP processor w/ 16-band EQ and time correction.
- Multimedia player via USB port
- Reversing camera ready: Compatible w/ aftermarket reversing cameras.
- Integrated GPS navigation (3 years of free map updates) w/ 3D view, online TMC & TTS
- The D8-DCX2022 Pro is also compatible with Fiat Ducato, Citroën Jumper & Peugeot Boxer from 2006 onwards in combination with 850380 mounting frame

Technical data:

Media playback (Audio: APE/FLAC/M4A/MP3/WMA/WAV. Video: MPEG-4/AVI/FLV/MPEG/MPG/DAT/VOB/MKV), SD card slot, 2 x USB port, AV input / AV output, Automatic station preset APS stores 5 stations with the best signal on page 3, Manual station preset for 15 stations.

Fiat Ducato 8 from 09/2021	850377	1307,-
Mounting frame for installation in Fiat Ducato up to 08/2021,CitroënJumper & Peugeot Boxer from 2006 onwards	850380	20,80

Scan the QR code and get all the technical data on this product. (www.dynavin.de)



incl. remote control

Dynavin reversing cameras can be found on pg. 462.



10" Display

Installation instructions: This device only fits if no radio is fitted ex works was installed in the vehicle.

Also available with mounting frame for Fiat Ducato 2006-08/2021

Climate control panel not incl. in scope of delivery.



Optional Accessories

① DVN-APTDC for Fiat Ducato 7

Support of the Fiat Ducato (2006-09/2021) by DVN-APTDC
850380 20,80

② DYN-DCLIN01 for Fiat Ducato 8 w/ telephone button

Support of telephone button at steering wheel control on Fiat Ducato 8 (from 09/2021) by DVN-DCLINOT
850382 86,20

③ D8-UFT01 & ④ DVN-CABDC8

Support for the vehicle settings of Fiat Ducato with factory radio
D8-UFT02 (Fiat Ducato 2006-09/2021) for Ducato 7 multifunction steering wheel 850389 119,-
DVN-CABDC8 (Fiat Ducato 8 from 09/2021) with original Fiat radio 850384 16,40

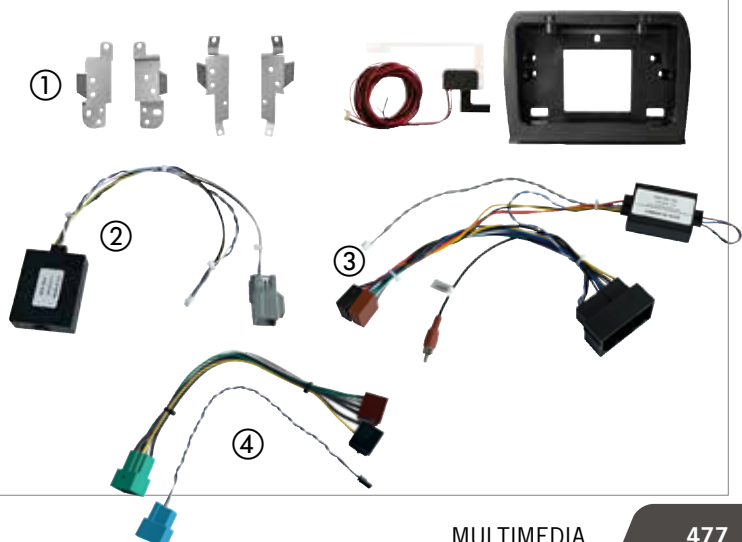



XZENT



Naviceiver X-F275

For Fiat Ducato, Citroën Jumper, Peugeot Boxer > 2006

- Capacitive 8"/20.3 cm (X-F275) real glass touchscreen
- Apple CarPlay
- AndroidLink for Android OS smartphones with dual-protocol support
- FM RDS tuner with DSP
- DAB+ twin tuner w/ dynamic station list, DAB-DAB service following, MOT slideshow, DLS text
- Bluetooth unit w/ hands-free function & A2DP music streaming, internal & external microphone
- Two USB 2.0 ports, 2 extension cables included in scope of delivery
- HDMI, 4 x 40 watt amplifier, Made for iPod / iPhone
- Control of up to two cameras w/ automatic switching function, superimposable guide lines, CAM direct selection button
- IR remote control, direct connection to steering wheel remote control, IR-IN for CAN/LFB interface
- 1 x cinch A/V input, 1 x cinch video output



XZENT's X-F275 infotainer is perfectly matched to FIAT Ducato III, Citroën Jumper II & Peugeot Boxer II - both visually & technically. The X-F275 has a large capacitive 8"/20.3 cm real glass touchscreen and masters the full infotainment program. In addition to analog FM tuner, it offers DAB+ w/ all the convenience of a dynamic season list, DAB-DAB service following, MOT slideshow & DLS text. Two USB 2.0 ports take care of audio and video playback.

X-F275 offers iPhone users Apple Car Play including Siri voice control, while owners of Android phones can look forward to pre-installed AndroidLink app: it enables screen content of Android smartphones to be mirrored on infotainer display & then direct control of mirrored apps via touchscreen of the X-F275.

Two reversing cameras can be connected to the X-F275, and auxiliary lines can be displayed and set.

With optional X-MAP27-MH1 or X-MAP27-MH3 navigation packages*, X-F275 infotainer becomes a comprehensively equipped naviceiver for motorhomes.

XZENT X-F275 850385 741,-

Suitable mounting frame for Fiat Ducato 8 from 09/2021 N-XFDUC8 850379 32,60



*The navigation software is not included in the scope of delivery of the X-F275.

Motorhome Navigation software

Upgrade your X-F270 infotainment system to a naviceiver: Software on 16 GB microSDHC card, coverage of 47 EU countries, realistic 3D display, lane assistant, tunnel mode, auto-zoom for intersections and traffic circles, intelligent calculation of alternative routes, etc. Europe Premium P.O.I.

package with over 6.5 million points of interest, Camping P.O.I. package with 20,000 points of interest & detailed information (multilingual: DE/EN/NL/IT/FR).

X-MAP27-MH1, 1 year free map update 850308 217,-
X-MAP27-MH3, 3 years free map update 850306 272,-



XZENT

X-107 & X-527 - Modern infotainment for your vehicle

- Capacitive 6.75" / 17.1 cm real glass touchscreen
- X-527: Apple CarPlay, Google Android AutoTM
- X-107: WebLink® 2.0, w/ support for smartphone audio & video players, YouTube, Waze, Genius Maps from Mirai
- DAB+ tuner with DAB-DAB / DAB-FM Service Following and DLS text, X-527 additionally with MOT Slideshow and Comfort Scan
- FM RDS radio w/ FM World Tuner (all regions)
- Two USB 2.0 ports (X-527), one USB 2.0 port (X-107)
- Bluetooth unit with hands-free function & A2DP music streaming, internal & external hands-free microphone
- 4 x 45 watt amplifier
- Volume control, illumination Sensor control buttons: RGB multicolor (X-527), white (X-107)
- Control of a reversing camera w/ automatic reverse gear function, fade-in guide lines w/ X-527
- X-527: 1 x AUX Cinch A/V input & 1 x HDMI input
- X-107: 1 x Cinch A/V input
- IR-IN for CAN/LFB interface

2-DIN INFOTAINER X-107

The X-107 with its capacitive 6.75"/17.1 cm real glass touchscreen fits into any motorhome w/ a 2-DIN slot & offers the latest entertainment functions. The clear front panel with four sensor buttons and a practical volume control knob shows that the X-107 is a truly convenient device. The X-107 is equipped with a DAB+ tuner and an FM world tuner, and via Bluetooth you can not only make calls but also stream music wirelessly from your smartphone. Thanks to the integrated WebLink 2.0 function, you can easily use various apps on your Android or iOS smartphone.

2-DIN INFOTAINER X-527

X-527 is a top-equipped 2-DIN infotainer w/ a 6.75"/17.1 cm real glass touch-screen, DAB+ tuner, FM world tuner, Bluetooth unit for hands-free calling & music streaming, two USB ports, a camera-in & an HDMI input. You can connect your smartphone directly to media center via USB - X-527 then supports Apple CarPlay & Google Android AutoTM. Make calls, navigate, send & receive messages or simply listen to music & podcasts - you can conveniently control all functions using Siri, the Google voice assistant or via media center display.



XZENT X-107	850395	305,-
XZENT X-527	850396	435,-

Installation panels

1-DIN for installation of 1-DIN devices in 2-DIN slot, incl. storage compartment



For Fiat Ducato, Peugeot Boxer, Citroën Jumper (from 2006 to 09/2021)	815327	32,70
For Ducato 8 (from 09/2021)	81609	35,70
For MB Sprinter, VW Crafter (until 2018)	815329	32,70

2-DIN for the installation of 2-DIN devices in a 2 DIN slot

For Fiat Ducato, Peugeot Boxer, Citroën Jumper (from 2006 to 09/2021)	815322	27,20
For Ducato 8 (from 09/2021)	81608	38,10
For MB Sprinter, VW Crafter (until 2018)	815323	27,20
VW T5 startline/transporter (until 2015)	815325	31,60

Fiat Ducato HQ fascia

- High quality for Fiat Ducato > 2006
- Fits perfectly with the interior design
- Installation kit included

Perfectly matched to interior of Fiat Ducato & identical models from 2006 onwards. For the installation of 2-DIN devices for vehicles with radio preparation.

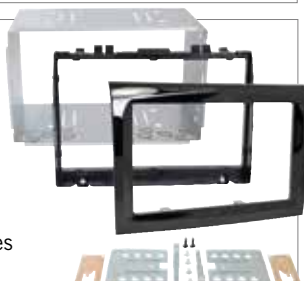

High gloss black	81567	49,60
Black matt (not shown)	81563	59,90



Installation frame for X-F275 for installation in Fiat Ducato 8 from 09/2021

Radio mounting bracket for the installation of an XZENT X-F275 device in Fiat Ducato III, Series 8 based vehicles. 4x M5x6 countersunk screws for fixing the device. Front panel with side mounting plates made of ABS plastic. For Fiat Ducato 8 from 09/2021 w/ radio preparation.

Notes on installation and function: The original holder of the radio preparation is replaced by the N-XFDUC8 frame. It is attached using the four original screws, ensuring quick and easy installation. The metal mounting frame supplied w/ X-F275 is not required for installation in Ducato 8. Depending on vehicle body manufacturer, additional antenna adapters, FM/DAB switches or ISO cable sets w/ radio switches may be required.

N-XFDUC8	850379	32,60
-----------------	---------------	--------------



Radio/dock



10" control panel



MB Sprinter mounting kit



Connection cable set is incl. in installation kits

Garmin Vioo infotainment for recreational vehicles (Fiat Ducato & Mercedes-Benz Sprinter)

- Detachable 10" control panel
- Garmin navigation with voice control for motorhomes
- 4 camera inputs for connecting compatible cameras
- Map & software updates via WiFi connectivity

The Vioo™ radio/dock is the basis for the fully integrated infotainment system and therefore the first step for installation in the motorhome. It enables many applications on one system, provides power for charging the control panel when docked and is compatible with the detachable 10" control panel. The removable control panels can be used as a remote control inside and outside the motorhome. Operation is also possible via the free FUSION-Link™ app for smartphones. The system offers full Fusion®media integration for multi-zone volume control. Specific navigation offers voice control, warning functions & special destinations for your motorhome vacation. Integrated safety features, including fatigue warning, advanced driver assistance features (requires front camera and custom configuration for installation) and more.

Vioo RV 52 radio/dock Required as a base station for a control panel.
Dimensions: 17.6x7.12x13.5 cm **850370** **817,-**

10" Vioo RV 1052 control panel 10" screen diagonal (21.6x13.5 cm), resolution 1280x800 pixels. Integrated, rechargeable lithium-ion battery. Dims.: 24.5x15.4x1.7 cm, scope of delivery incl. USB cable & instructions.

850372 **926,-**

Accessories for Garmin Vioo

Mounting kit for Fiat Ducato & Citroën (not shown)
Compatible w/ Fiat Ducato YOC. 2006 - 2021. Includes external hands-free microphone, cover, holder, cable set & adapter for steering wheel remote control.
For Ducato, Citroën from 2006 **850374** **164,-**
For Ducato 8 ab 09/2021 **850376** **164,-**

Mounting kit for Mercedes Sprinter
Contains external hands-free microphone, cover, holder & cable set.
MB Sprinter from YOC. 03/2018 **850373** **164,-**
MB Sprinter W906 up to model year . 03/2018 **850386** **217,-**

Additional charging station for 8" and 10" control panel (not shown) For surface-mounted installation, e.g. in vehicle living area. **850375** **142,-**

USB socket, for installation in glove compartment (not shown) **815083** **38,20**



Kenwood DNR992RVS Navitainer with 10.1 inch HD display with Garmin map data for motorhomes, digital radio DAB+ & smartphone connection

- 25.7 cm (10.1") HD display w/ "OPTICAL BONDING" technology
- Integrated Garmin navigation system especially for motorhomes, trucks and cars
- 3 years from activation free map updates
- Anti-reflective and anti-glare screen surface - readable from any viewing angle
- HD camera input for front/rear view camera
- Rear-view camera can be permanently activated as a rear-view mirror

The Kenwood Navitainer DNR992RVS for motorhomes: Garmin navigation, Wireless CarPlay & Android Auto or Android Wireless Mirroring, DAB+ digital radio, Wireless Hi-Res Audio, parametric equalizer, four camera inputs & much more. If you opt for the Navitainer DNR992RVS, you are already on the right track. Integrated Garmin navigation, with pre-installed POI database from Camp-ercontact, is specially tailored to requirements of motorhome drivers. Thanks to its sophisticated anti-reflective coating, the pioneering and responsive 25.7 cm (10.1") HD touch display shows the most beautiful routes & videos w/ high contrast & impressive brilliance - even in bright sunlight. The extensive features for audio, video & radio playback, flexible smartphone integration, four camera inputs & much more make the DNR992RVS the ideal companion.

850393 1743,-



Kenwood DMX8021DAB-CAMPER moniceiver with 7-inch display, SYGIC motorhome software & wireless smartphone connectivity (CarPlay, Android Auto)

- Integrated Sygic navigation software especially for motorhomes
- 17.7 cm (7") high-resolution WVGA double DIN monitor
- Capacitive high-gloss touch panel
- With anti-reflective & anti-glare screen surface
- Clear user interface w/ menu displays in 22 languages
- Adjustable viewing angle for ideal readability
- Freely selectable widgets on the home screen
- Low installation depth of only 85 mm
- Wireless Apple CarPlay & Android Auto for smartphones
- Bluetooth hands-free kit
- USB TYP-C port with fast charging function
- 4 camera inputs
- 3 years from activation free map updates

Capacitive touch display installed in new DMX8021DABS moniceiver has an anti-glare coating that makes surface noticeably anti-reflective without any loss of clarity or contrast. This means that the screen is easy to read even in direct sunlight. Together with the anti-reflective coating, the new display ensures outstanding image quality and readability.

850394 817,-



Kenwood CMOS-740HD front & rear view camera Rear view camera

- Wide-angle lens: 180° horizontal / 103° vertical
- Picture in true 1280 x 720 (720P) HD res.
- High light sensitivity Color rendering
- Water-protected housing (IP67)

The CMOS-740HD camera can be connected to the front or rear camera input of the DNR992RVS (Item No. 850393) and displays the image in true 1280 x 720 (720P) HD resolution. High Dynamic Range (HDR) technology used by camera also helps to eliminate image distortions caused by particularly dark or bright lighting conditions, making it the ideal front/rear camera option. 12/24V voltage.

47825 239,-





9" Display

AVIC-Z1000DAB-C

9" MEDIA CENTER WITH MOTORHOME NAVIGATION

- 9" navigation/media center with Wifi, Apple CarPlay™, Android Auto™ and DAB
- Capacitive 9" WVGA touch panel, 800 x 480 pixels
- 2x USB interfaces (rear)
- Connection of compatible smartphones - also wireless, depending on function & smartphone type
- Rear view camera connection, automatic switching, parking guidance lines
- Connection for second camera
- 44 European countries pre-installed in internal 16 GB memory
- 3 years free map update

All-in-one 9" motorhome navigation w/ 9" touchscreen (22.8 cm), rotary control for volume & on/off, quick selection button for reversing camera, DAB+, FM, Bluetooth® (hands-free calling, 2 telephones, audio streaming). Apple CarPlay™ and Android Auto™ via USB or wirelessly. 4 x 50 W, 2 USB inputs, 2 camera inputs, A/V inputs & outputs, graphic 13-band equalizer & much more.

Pre-installed European navigation, detailed information on over 20,000 pitches/camp-sites from ProMobil portfolio.

Input of vehicle data for route calculation (height, width, length, weight, number of axles). Including 3 years of free map updates.

For Fiat Ducato 8 from 09/2021*	815692	1661,-
For Fiat Ducato until 08/2021, Citroën Jumper & Peugeot Boxer from 2006	815690	1661,-



9" Display

SPH-EV0950DAB

9" SMARTPHONE RADIO WITH WI-FI®, ANDROID AUTO™, APPLE CARPLAY™

- Capacitive 9" Touch panel
- 2 connections for cameras

9" touchscreen (22.8 cm), quick selection button for reversing camera, DAB+, FM, Bluetooth® (hands-free calling & audio streaming). Apple CarPlay™ and Android Auto™ via USB or wirelessly. 4 x 50 W, USB input, 2 camera inputs, A/V inputs & outputs, graphic 13-band equalizer & much more.

MOTORHOME NAVIGATION APP SYGIC INCLUDED:

3 years free of charge for 5 family members, European motorhome navigation, input of vehicle data for route calculation (height, width, length, weight, number of axles). ProMobil database w/ information on 20,000 parking spaces, operation on screen via Apple CarPlay, Android Auto or WebLink 2.0. Online information (with traffic information and assistance functions). Storage of the map material on the smartphone, therefore also fully usable offline.

For Fiat Ducato 8 from 09/2021*	815694	1035,-
For Fiat Ducato up to 08/2021, Citroën Jumper & Peugeot Boxer from 2006 onwards	815695	1035,-
For Ford Transit Custom from 2018	815696	1035,-
For Mercedes-Benz Sprinter, suitable for W906 06-17, W907/910 from 2018	815698	1035,-



6,8" Display

Pioneer SPH-DA160DAB 2-DIN Moniceiver

- Capacitive 6.8" touch panel
- 800x480 pixels
- Camera connection plus additional A/V input
- Display of parking aid lines
- Bluetooth hands-free parallel operation of two phones

6.8" capacitive touchscreen (17.3 cm), Bluetooth with hands-free calling and audio streaming, DAB+, FM, 4 x 50 W, 13-band graphic equalizer, camera input and much more. Only 125 mm deep short chassis for easy installation. Connection of compatible smartphones possible via Apple CarPlay™ & Android Auto™, USB mirroring for Android, capacitive 6.8" touch panel, 800x480 pixels, adjustable button illumination, background image customizable, USB interface (rear, extension included), playback of HD videos, NTFS-compatible, A/V inputs/outputs, camera connection plus additional A/V input, display of parking aid lines, 4x27W DIN sine, 3 pairs of cinch preamp outputs, adjustable subwoofer crossover, adjustable high-pass filter, input for car-specific steering wheel remote control (adapter optional accessory). Scope of delivery: Pioneer SPH-DA160DAB 2-DIN moniceiver, incl. connection cable, external microphone & mounting accessories.

494039 490,-

*not suitable for Peugeot Boxer and Citroën Jumper from 09/2021



Avtex/Garmin TOURER THREE

Intelligent satellite navigation

- 6.95" (17.7 cm) capacitive HD display
- Sat Navigation GPS improved for caravans and motorhomes
- Official location data of the Caravan and Motorhome Club
- Free Live traffic and map updates
- Exclusive database of European campsites
- Hands-free calling including Bluetooth calls
- Reach your destination and avoid roads with height, width and weight restrictions
- New routes for low emission zones
- Mith BirdsEye satellite images that show you where you must
- Information on road restrictions & elevation profile
- Adjustable profiles for caravans & motorhomes

Avtex/Garmin Tourer Three was developed to simplify the navigation of caravans & motorhomes. Simply enter technical data of your motorhome or caravan and Avtex Tourer Two will find the most efficient route to your destination throughout Europe. Your route is calculated based on the data entered.

In addition, they get exclusive access to Caravan & Motorhome Club campsite database, which allows you to search, filter & view all Club campsites to find a special place to stop and explore. In addition to the club's information, Tourer Three is preloaded with databases from ACSI, Trailer Park and Camper Contact, giving you access to thousands of campsites in Europe with TripAdvisor reviews.

Tourer Three can suggest interesting places along your route that you might like to visit. There are high-resolution Birdseye satellite images of your target to help you set up. Dims. (W x H x D): 173 x 99 x 19 mm. Weight: 240 g

Scope of delivery;

navigation device, suction cup mount for windshield, car connection cable with 12V plug, quick start guide.

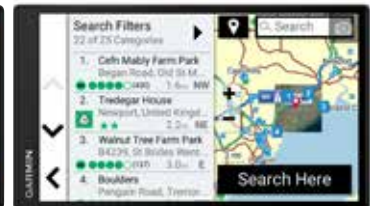

850391

490,-

PIONEER DEH-S720DAB

with integrated Digital radio receiver

- MP3/WMA playable
- Integrated digital radio receiver
- Adjustable RGB lighting
- iPod direct control via USB
- Remote control via Android app

Menu German/English/French/Russian/Turkish, RDS, FM/MW/LW, 24 station memory, CD drive, MP3/WMA playable, 1.5A Quick-Charge USB (incl. FLAC playback), iPod control via USB, AUX-In on front panel, MOSFET 50: 4 x 50 W max, 4 x 22 W DIN sine, 3 pairs of high-voltage preamp outputs, 3-way active crossover, delay time correction, 13-band equalizer, Advanced Sound Retriever (ASR), optional adapter, rotary volume control, ISO connection cable, removable front panel, backup memory.

494040

186,-

DAB+ antenna for Pioneer DEH-S720DAB

- For digital DAB+ reception
- Thousands of stations in best sound quality

DAB+ reception opens up world of digital radio to you with thousands of stations and crystal-clear, digital sound quality. This antenna is compatible with Pioneer DAB-capable CD/DVD tuners and corresponding media centers.

494066

38,10



Permanent memory retains the storage, when disconnecting battery



ADAPTERS FOR CAR RADIOS AND DAB+/GPS ANTENNAS

For the best reception of FM/DAB+ and GPS in vans or motorhomes

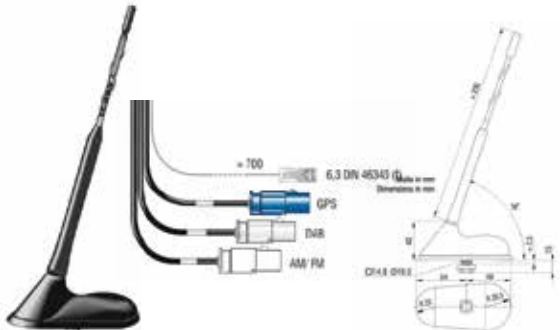

12V Roof antenna for panel van with metal roof

- VHF/DAB+/GPS and GLONASS reception
- Active, small and powerful
- 3x Fakra plug for connection to almost all end devices
- Including 7.5 m connection cable

Especially for panel vans with metal roofs, e.g. Fiat Ducato, where antenna is mounted directly on metal roof. Cables are fed directly into the vehicle through a central drill hole (Ø 20mm).

Scope of delivery: rod antenna (height 23 cm), VHF, DAB+, GPS & GLONASS cable & adapter set to DIN, ISO, FAKRA, SMB, GT5, GT16 (length 7.5 m).

49170 250,-

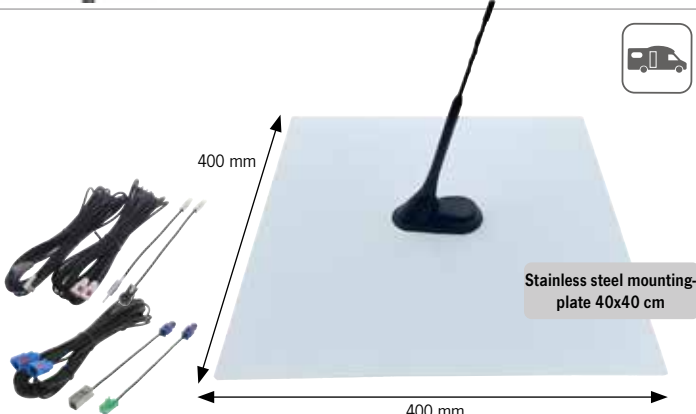

12V roof antenna for motorhomes with GRP roof

- VHF/DAB+/GPS and GLONASS reception
- 3x Fakra plug for connection to almost all end devices
- Including 7.5 m connection cable

Antenna with stainless steel mounting plate powder-coated in RAL 9003 (white, size 40x40 cm) – specially developed for vehicles w/ GRP roofs. The stainless steel plate amplifies the received signal and is affixed to the vehicle roof. (Manufacturer's recommendation: Dekalin adhesive set SetMS5, item no.: color white 500305). Cables are fed directly into vehicle through a central drill hole (Ø 20mm) under mounting plate. Gain: FM 14dB, DAB+ 10 dB, GPS/GLONASS 28 dB.

Scope of delivery: rod antenna w/ stainless steel mounting plate, VHF, DAB+, GPS & GLONASS cable & adapter set to DIN, ISO, FAKRA, SMB, GT5, GT16 (length 7.5 m).

49175 305,-



Active 12V combiflex roof antenna for motorhomes with GRP roof

- FM/DAB+/GPS Glonass reception
- Plastic housing with integrated aluminum plate
- Enables flexible cable entry into roof thanks to extended connection cables (50 cm) at antenna base
- Can be screwed and / or glued together
- 12 V power supply for the FM / DAB amplifier either via internal conductor or external cable connection with DIN plug-in sleeve

Scope of delivery: Roof antenna (height of antenna rod: 23 cm), mounting plate, 6.5 m FM (DIN), DAB+ (SMB), GNSS (FAKRA) connection cable, dust protection seal, thread extension w/ nut.

49172 326,-

GPS connection adapter

Xcent	815313	10,90
Pioneer	815314	16,30



Center switch for MB Sprinter W907/W910

For harmonious integration of center speaker in Mercedes Sprinter sound system (for connection to factory loudspeaker system).

81743 27,20



Listen to the radio even when the ignition is switched off!

With this adapter, this works independently of the ignition. Radio adapter cable ISO - ISO with switch for motorhomes. When the adapter is switched off, operation is again dependent on the ignition.

815310 30,-



Active antenna signal splitter between AM/FM and DAB+

DAB+/FM crossover active with amplifier. Division of the FM and DAB+ frequency ranges (DIN/SMB). Compatible with passive rod aerials, e.g. Fiat Ducato panel van with articulated aerial.

815311 53,40



Volkswagen adapter cable for radios

MOST/Quadlock to ISO + ignition plus connection cable & phantom power Fakra ISO. For connecting a car radio or universal 2-DIN device to the Volkswagen MOST connection. No CanBus interface is required.

815326 27,20



- For Fiat Ducato original DAB+ roof or mirror antenna on DAB+ radios with SMB socket
- Perfect for Adria and Sun Living vehicles

Adapter particularly important for ADRIA & SUNLIVING, as the factory-fitted DAB+ antenna is installed in Ducato mirror. For the connection of XZENT, PIONEER or KENWOOD DAB+ devices.

815312 24,-

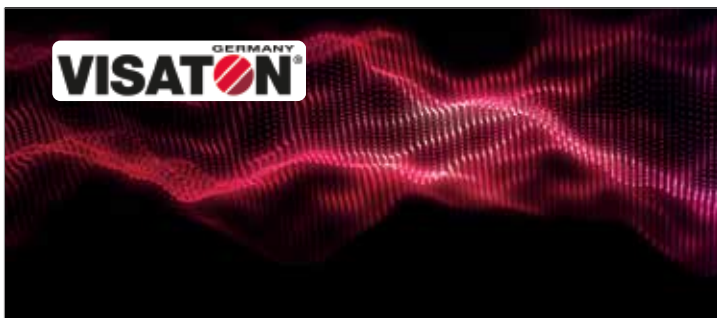

VISATON GERMANY



① **Low Installation depth**



② **Mounting plate**

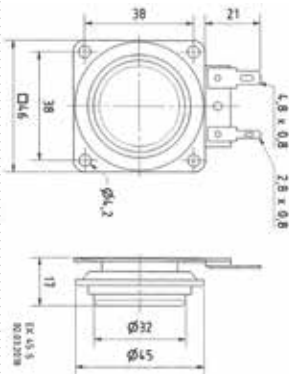
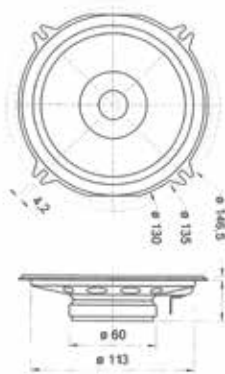

③ **Accessories Protective grille for FR 12**



④ **Loudspeaker cable**

① **FR 12 The 28mm ultra-flat furniture loudspeaker**
13 cm (5") full-range speaker with inverse surround. Particularly flat design (only 28 mm), so can be used wherever space is at a premium.
(1 piece) **49811 23,70**

② **Exciter EX 60 S The individual flat-panel loudspeaker**
Exciter, also known as a body sound transducer or body shaker. They can be attached to surface of the panel to be stimulated using adhesive or screws. Possible applications: Signal output in all kinds of applications where no visible loudspeakers can be installed for design reasons or to protect against environmental influences or vandalism (e.g. under the drop-down bed). Technical parameters depend on material, Dimensions and shape of panel to be stimulated.
49810 65,40

③ **Accessories Protective grille for FR 12** (1 pc) **49809 8,40**

④ **Loudspeaker cable** (10m, 2x 0.75mm²) **810629 12,10**

*Max. Long-term performance according to DIN EN 60268-5	FR 12	Exciter EX 60 S
Nominal/music load capacity	15 W / 40 W	25 W *
Impedance	4 Ω / 8 Ω	8 Ω
Transmission range (- 10 dB)	70-18000 Hz	
Average sound pressure level	85 dB (1 W/1 m)	
Limit deflection xmech	± 2.5 mm	
Resonant frequency	110 Hz	
Upper pole plate height	3 mm	
Voice coil diameter	20 mm	32,5 mm
Changing height	4,5 mm	
Baffle opening	114 mm	
Net weight	0,284 kg	0,12 kg

Only 11.6 cm wide

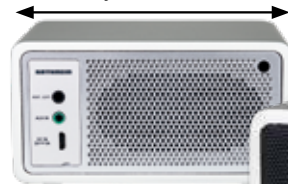

Mobile mini radio

Rechargeable battery



KATHREIN

DAB+ Mini Radio

- DAB+ and FM receivable
- Bluetooth for audio streaming
- OLED display showing DAB service and information
- Integrated, rechargeable battery for high mobility
- Incl. Throw antenna 3.5 mm

With the pocket-sized DAB+ mini radio, you can enjoy noise-free radio reception in top quality. Additional Bluetooth function enables wireless audio streaming, e.g. from mobile & integrated rechargeable battery offers high mobility.

Technical data: Output power RMS: 1.6W, rechargeable, integrated Li-Ion battery with 2600 mAh. Charging connection: Micro-USB port 5V 1A, charging current: 500mA. Operating temperature: 0°C to +35°C.

Dims.: WxHxD 116x73.5x65 mm, weight: 0.4 kg

Housing silver

49767

152,-

Pioneer

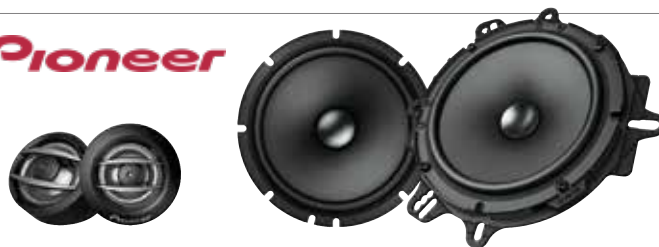

Pioneer TS Fiat Ducato sound system: Practical complete package for sound enhancement

- Suitable for Fiat Ducato, Peugeot Boxer & Citroën Jumper
- Adapter rings for precise mounting
- Practical Plug connections
- Illustrated installation instructions in German
- 16,5 cm 2-way Component loudspeaker
- Max. load capacity 350 W, 80 W RMS

With tailor-made 2-way component speaker upgrade set from Pioneer, you can quickly & easily upgrade factory-fitted audio system of your Fiat Ducato X250/X290 (from 2006)*. Practical, high-quality plug & play complete package, which is suitable for self-installation, is particularly easy to install* thanks to installation & cable connection adapters supplied. The vehicle-specific installation instructions included in set will guide you safely through installation process.

81708

190,-

Scope of delivery:



*Depending on vehicle, additional installation materials may be required.

2-way front system plug & play for Ducato & Sprinter

- Guaranteed high quality & first-class listening pleasure in cab
- Installed in a few simple steps
- Pre-assembled for original installation locations and plug & play
- Can be expanded with an amplifier, 2-way system or subwoofer



Also suitable for Fiat Ducato 8 (from 09/2021)

For Fiat Ducato, Peugeot Boxer & Citroën Jumper > 2006

Speaker configuration: 2x 165 mm JEHNERT power woofer "XA165", 2x 19 mm neodymium soft dome tweeter "XA19Duc", 4x aluminum butyl mats

81737 217,-

Technical data: Power handling continuous/music: 2x70/140 watts; Frequency response: 49 - 22,000 Hz; Impedance: 4 Ω; Rec. Amplifier power from 2 x 40 - 80 watts at 4 Ω



For Mercedes Sprinter W907/W910

Speaker configuration: 2x 165 mm JEHNERT Power Woofer "XA165", 2x 19 mm neodymium soft dome tweeter "XA19", 1x center crossover

81738 272,-



For Fiat Ducato and MB Sprinter

Further details & optional accessories on page 477

AMP V40 CampTec 4-channel amplifier

- For radio, TV, smartphone and tablet
- Radio connection: High-power input for automatic switch-on
- TV connection via AUX-In TV, jack input 0.1-5V adjustable
- BT connection via BT AUX-IN, jack input 0.1-5V adjustable
- 2x 3.5mm jack input - incl. 2m jack cable
- High-level / RCA input as secure as RCA input thanks to plug & play connections

81739 131,-

Necessary accessories for AMP V40 amplifier:

ISO cable for amplifier incl. subwoofer interface (not shown) for retrofit radio & connection to original radio (note: additional radio adapter required for original radio) **81744 40,30**

Radio adapter cable (not shown)

For adapting the amplifier to the factory radio via ISO. Enables easy installation of the Plug & Play amplifier on the original wiring harness.

For Fiat Ducato 8 from 09/2021 **81746 38,20**

For Mercedes Sprinter W907/W910 for models without E3D interface **81747 51,20**



Optional accessories:

Mounting bracket for Fiat Ducato, Peugeot Boxer, Citroën Jumper from 2006 onwards
Allows amplifier to be mounted behind glove compartment. **81748 8,75**

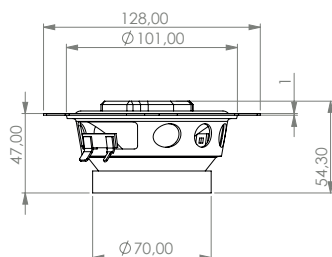

High-quality 2-way 100mm coaxial system

The 2-way rear system completes the living area with optimum surround sound. Two 100 mm coaxial loudspeakers ensure greatly improved basic sound reproduction. Incl. Mounting ring and cover grille. **81756 76,20**

Technical data:	100mm midrange driver & 13mm neodymium tweeter
Load capacity (RMS)	60 watts
Maximum power	120 watts
Impedance	4 Ohm
Installation dims.	Ø 94 mm x D 48 mm

Bass reflex subwoofer - with 1x165mm dual voice coil incl. subwoofer cable

The task of a subwoofer is to support the low frequency range. JEHNERT bass reflex subwoofers in various sizes have been specially developed for recreational vehicles with limited space. Despite the small housing volume, they deliver

maximum sound quality. All subwoofers have a "plug & play" connection cable and are powered by the compact 4-channel amplifier to save energy. To connect the passive subwoofer, an amplifier (e.g. 81739) is required.



Fiat Ducato, Peugeot Boxer & Citroën Jumper from 2006 onwards

Mounting below cup holder in center console.

Attention: Only suitable for models with cup holder.

Weight 4.5 kg **81742 408,-**



Mercedes Sprinter W907/W910

Ideal for seat console, passenger side or seating area. Dims. (LxWxH): 31 x 23.5 x 19.3 cm Weight 5.6 kg

81755 337,-

2-way front system plug & play for Volkswagen T6.1/T6

The 2-way sound system for cab guarantees high quality and first-class listening pleasure. Precisely fitting tweeters and a 165 mm woofer made of paper cone in the vehicle door provide an absolute sound upgrade. The 2-way front system can be installed in just a few simple steps & provides ideal basis for expanding speaker system with an amplifier and subwoofer to increase the sound quality. The original installation slots and plug & play connectors for the original plugs are used for easy installation.

Technical data:

Power handling continuous/music: 2x70/140 watts; Frequency response: 49 - 22,000 Hz; Impedance: 4 Ω; Rec. Amplifier power from 2 x 40 - 80 watts at 4 Ω

Speaker configuration:

2x 165 mm JEHNERT Power Woofer "XM165",
2x 25 mm neodymium soft dome tweeter "XA25VW"
JEHNERT crossovers, vehicle-specific calibrated

For Volkswagen Transporter 6 **81735** **305,-**
For Volkswagen Transporter 6.1 **81736** **305,-**



AMP V40 CampTec 4-channel amplifier for VW T6.1/T6

- For radio, TV, smartphone and tablet
- Radio connection: High-power input for automatic switch-on
- TV connection via AUX-In TV, jack input 0.1-5V adjustable
- BT connection via BT AUX-IN, jack input 0.1-5V adjustable
- 2x 3.5mm jack input - incl. 2m jack cable
- High-level / RCA input as well as cinch input w/ plug & play connections guaranteed to be latch-proof

The compact and versatile JEHNERT® "Mini 4-channel amplifier" Amp V40 CampTec impresses with its new innovative technology, simple operation & intelligent switching of desired music sources.

With a total output of 320 watts/2 ohms, a front & rear speaker system or a front system including subwoofer can be operated without any problems. Thanks to the highly innovative and efficient technology, the radio's existing power supply can also be used for the power amplifier. (No external power supply required).

81739 **131,-**

Note: an ISO cable must be ordered separately for connection to radio / head unit, as well as a radio adapter cable if necessary

Necessary accessories for AMP V40 amplifier:

ISO cable for amplifier incl. subwoofer interface (not shown) for retrofit radio and connection to original radio (note: additional radio adapter required for original radio) **81744** **40,30**

Radio adapter cable (not shown)
For adapting the amplifier to the factory radio via ISO. Enables easy installation of plug & play amplifier on original wiring harness in vehicle.
For Volkswagen Transporter 6.1/6 **81745** **49,-**



Technical data "AMP V40 CampTec" 4-channel amplifier with 2x jack and 4x high/low level input	
Operating voltage / fuse	10 - 16 V / 1x 15A
Output power at 14.4 V	4x 40/80 Watt - @ 4 Ohm
-RMS power @4/2 Ohm stereo	4x 60/120 Watt -@ 2 Ohm
High-pass filter (HPF) channel 1+2 continuously adjustable	from 50 to 4,000 Hz
High-pass filter (HPF) channel 3+4 continuously adjustable	from 50-400 Hz
Low-pass filter (LPF) channel 3+4 continuously adjustable	from 80 -2,500 Hz
Dimensions (H x W x D) / Weight	45 x 162 x 80 mm / 400g

Optional accessories for AMP V40 amplifier:

Bluetooth receiver 3.5 mm jack (not shown)
Establishes a wireless connection between smartphone & amplifier, without switching on radio/MBUX **81753** **54,40**

Interference suppression filter 3.5mm jack (not shown)
Removes and prevents noise from TV or radio, frequency: 2 - 20,000 Hz, connection via 3.5 mm jack. No power supply required. **81749** **23,90**

Jack cable 7.5m (not shown)
For connecting an amplifier or radio to the TV **81754** **8,75**

Bass reflex subwoofer - w/ 1x165mm dual voice coil incl. subwoofer cable

The task of the passive subwoofer is to support the bass range. It has a "plug & play" connection cable & can be supplemented by additional compact 4-channel amplifier (e.g. a 4-channel amplifier). 81739) can be driven in energy-saving manner.

For Volkswagen T6.1/T6
Ideal for under the passenger seat.
Weight: 4.84 kg
81741 **283,-**

Technical data (item no. 81742, 81755, 81741)	Subwoofer
Output power at 14.4 V - RMS power @4/2 Ω stereo	1x 100 W sine wave / 200 W
Max. linear diaphragm stroke	+ / - 5,0mm
Efficiency 1W/1M/impedance	2x 2 Ω
Transmission range	32-180 Hz
Membrane material	Handmade paper membrane

