



AWNINGS / AWNING TENTS

Mosquito Free PREMIUM

Attachable mosquito net tent for awnings



Moskito Free PREMIUM - Mosquito net tent for awning

- Hook-in mosquito net tent with floor
- Available in 2 widths
- Suitable for many awnings
- Keeps mosquitoes and other pests away

The mosquito net tent is attached to the awning arms with hooks. This premium version is equipped with a sewn-in bottom.

Scope of delivery:

Tent incl. pegs and packing bag

Premium 240 , width 240 cm	900164	119,-
Premium 300 , width 300 cm	900165	141,-

Further information on page 131

Reimo Tent Technology awning blinds.....	128 – 129
Reimo Tent Technology awning accessories.....	130 – 131
Info awning adapter.....	132 – 134
Info Fiamma awnings.....	135
Fiamma roof awnings & adapters.....	136 – 140
Fiamma awnings roof awnings.....	141 – 142
Fiamma wall awnings & adapters.....	143 – 146
Fiamma awnings, wall awnings.....	147 – 148
Fiamma awnings VW, buses & vans.....	149 – 151
Fiamma awnings minivans & adapters.....	152 – 153
Fiamma Minicamper awnings.....	154
Fiamma awning set with awning.....	155
Fiamma caravan awnings.....	156 – 157
Fiamma front & side panels.....	158 – 159

Fiamma accessories & spare parts.....	160 – 162
Info Thule awnings.....	163
Thule roof awning & adapter.....	164 – 167
Thule wall awning for motorhomes.....	168 – 169
Thule awning for buses & vans.....	170 – 171
Thule adapter for wall awnings.....	172 – 173
Thule caravan awnings.....	174
Thule Subsola triangular panel.....	175
Thule Blocker.....	176 – 177
Thule awnings.....	178 – 180
Thule Accessories & Spare Parts.....	181 – 182
Dometic awnings & accessories.....	183
Rafters, storm locks & accessories.....	184 – 187
Awning lighting.....	188 – 189



Awning blinds for caravan
for mounting height 225 - 245 cm



INFO



COLOR COMBINATION



Villa Store

For awnings with attachment height 225 - 245 cm

- Complete set suitable for wall awnings with minimum extension 240 cm
- Water- & windproof material made of acrylic & vinyl
- Connection of the front and side parts with zippers and Velcro
- Windows with mosquito netting on the sides, window film in front, all with blackout
- Incl. Packing bag and curtain set

Complete set for motorhome or caravan awnings w/ wall mounting, mounting height from 225 - 245 cm. Sealing to vehicle is provided by large foam pads, reinforced guy points ensure stable installation. The side walls are held by supplied tension rods. A sealing strip, which is attached to the awning fabric with clips and Velcro, provides a waterproof and windproof seal.

VILLA Store

Wide	Weight	H: 225 - 245 cm	
500 cm	19,0 kg	475628	675,-
550 cm	19,0 kg	475629	708,-
600 cm	20,0 kg	475630	752,-

Awning blinds for motorhomes
for mounting height 250 - 280 cm



Suitable for awnings from
FIAMMA, THULE
and DOMETIC

INFO



COLOR COMBINATION



Villa Store Premium

For awnings with mounting height 250-280cm

- Fits many sidewall awnings from Fiamma, Thule, Dometic & Prostor
- Quick removal of the side panels through horizontal zipper at reach height
- Water- & windproof material made of acrylic & vinyl
- Connection of front and side parts with zippers
- Windows w/ mosquito netting on sides, window film in the front, all with roll-up blackout flaps
- Minimum extension of 240 cm required
- Incl. Packing bag and curtain set

Motorhome blinds for awnings w/ wall mounting & mounting height of 250 - 280 cm. Sealing on the vehicle by large foam pads prevents drafts, reinforced guy points ensure stable mounting. A sealing strip, which is attached to the awning fabric with clips and Velcro, provides a waterproof and windproof seal.

VILLA Store Premium

Wide	Weight	H: 250 - 280 cm	
500 cm	20,0 kg	475625	643,-
550 cm	20,0 kg	475626	671,-
600 cm	21,0 kg	475627	693,-

Villa Store Caravan SET



Front and side parts for FIAMMA caravan door incl. all curtains as Complete set. Existing consisting of 1 front section, 2 side sections and curtains for Fiamma caravan doors.

Front parts Villa Store Caravan Front

Front parts for FIAMMA caravan door incl. window with attractive stripe print.

Side parts Villa Store Caravan Side Side parts for FIAMMA caravan door left and right. Incl. Window with attractive stripe print. With 2 aluminum rods Ø 25/28 mm for upper attachment of side panels.

Scope of delivery 1 x front section, 2 x side sections, curtains, pack sack, ladder tensioning elements & pegs.

Material

210 D Oxford Polyester. Water column: 1000 mm.

Accessories

Pressure bar set with foam bead with Velcro, W 10 x L 219 x D 4 cm. Mounted between the side wall and caravan for windproof connection. With telescopic steel bars.

Material: 190 T polyester, weight: 3.0 kg.

475644 56,70

COLOR COMBINATION VILLA STORE XL



COLOR COMBINATION VILLA STORE



INFO

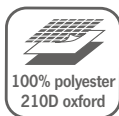

Especially for FIAMMA bag awning



REIMO TOP PRICE
from **224,-**



Caravan awning "Caravanstore" see page 156

Villa Store caravan front and side panels for FIAMMA caravan door



Villa Store XL Caravan SET - complete set of front part, side part & curtains

Type	for FIAMMA	Width (B)	Height (H)	Depth (T)	Weight	Item no.	Price
Villa Caravan XL285	Caravan Store 310 XL	285 cm	210 cm	240 cm	11,0 kg	47571	348,-
Villa Caravan XL335	Caravan Store 360 XL	335 cm	210 cm	240 cm	11,4 kg	47572	359,-
Villa Caravan XL385	Caravan Store 410 XL	385 cm	210 cm	240 cm	11,9 kg	47573	370,-
Villa Caravan XL415	Caravan Store 440 XL	415 cm	210 cm	240 cm	12,5 kg	47574	403,-

Villa Store Caravan SET - complete set of front part, side part & curtains

Type	for FIAMMA	Width (B)	Height (H)	Depth (T)	Weight	Item no.	Price
Villa Caravan 285	Caravan Store 310	285 cm	210 cm	215 cm	10,0 kg	47567	224,-
Villa Caravan 335	Caravan Store 360	335 cm	210 cm	215 cm	10,4 kg	47568	232,-
Villa Caravan 385	Caravan Store 410	385 cm	210 cm	215 cm	10,9 kg	47569	239,-
Villa Caravan 415	Caravan Store 440	415 cm	210 cm	215 cm	11,5 kg	47570	248,-

Villa Store Caravan Front - front part

Type	for FIAMMA	Width (B)	Height (H)	Weight	Item no.	Price
Villa Caravan 335	Caravan Store 360	335 cm	210 cm	3,3 kg	47564	60,-
Villa Caravan 415	Caravan Store 440	415 cm	210 cm	3,5 kg	47566	65,40

Curtain set for villa caravan front

Color	Weight	Item no.	Price
White	0,57 kg	475643	19,10



from **43,60**

i This sail does not protect from rain

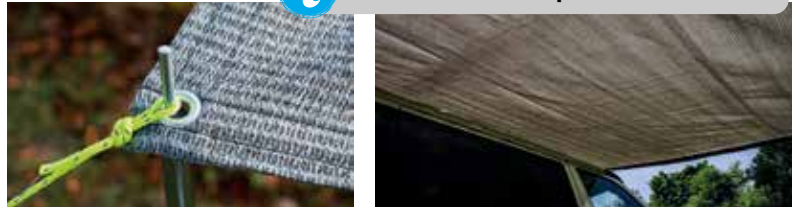

Shine Blind - in 4 widths with piping Ø 5/8 mm for Awnings and Multirail

- UV-resistant, reflective
- Slightly breathable - tip on hot days
- Easy assembly thanks to double piping Ø 5/8mm

The awning made of UV-resistant, reflective material has a double piping with Ø 5+8cm so that it can be used for standard awnings, but also for camper vans with multirails.

Delivery includes guy ropes in a practical carrying bag (pitching poles must be ordered separately!)

Color: dark gray, **Material:** 185g/m² PE (polyethylene).

W 240 x H 190 cm, app. 1.5 kg	906883	43,60
W 290 x H 190 cm, app. 1.8 kg	906884	49,-
W 340 x H 190 cm, app. 2.0 kg	906885	54,50
W 390 x H 190 cm, app. 2.2 kg	906886	59,90
2 set up rods	903076	16,30

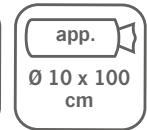

Sun protection frontfor roof and wall awnings with piping retraction

- Textile lattice fabric sunshade
- Protects from sun & reduces wind draught
- Suitable for all awning types with 6 mm keder rail in front profile
- Lattice fabric in light gray



Sun protection for all common types of awnings

Wide	Height	For awning work	Item no.	Price
280 cm	200 cm	from 300 cm	43910	76,30
330 cm	200 cm	from 350 cm	43911	87,20
380 cm	200 cm	from 400 cm	43912	98,10
430 cm	200 cm	from 450 cm	43913	109,-

Smartlock tent pole clamps 4 pieces per pack incl. pin wrench, screwless locking system.

No damage to the tent poles. For steel and aluminum.

Ø22/19 mm	91975	13,10
Ø25/22 mm	91974	14,20
Ø28/25 mm	91976	15,20



Clamping mechanism PowerGrip

- No deformation of the pipe
- Clamping mechanism w/o. galvanized steel parts
- Visually effective
- Can be retrofitted



PowerGRIP

A clamping device that makes screw connections superfluous. When unclamping the boom, it is sufficient to press the clamping mechanism lightly so that the tube is locked. This proven system can be subsequently exchanged for the pipe clamp.

Ø 32 mm / Ø 28 mm	91973	27,60
Ø 28 mm / Ø 25 mm	91972	25,20
Ø 25 mm / Ø 22 mm	91971	21,50
Ø 22 mm / Ø 19 mm	91970	20,50

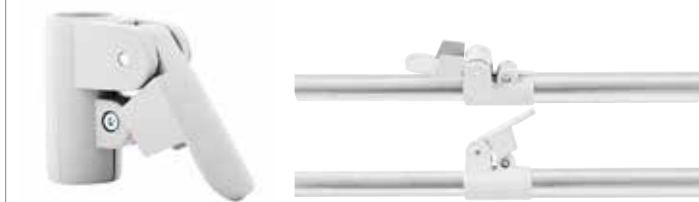



**Moskito Free -
Mosquito net tents for awning**

- Fastening under the awning arms
- Available in 2 widths
- Keeps mosquitoes and wasps away
- Small pack size
- Suitable for many awnings

The mosquito net tent is simply attached to awning arms w/ hooks & protects you from annoying mosquitoes, flies, wasps & other insects. The Premium version is equipped with a sewn-in bottom. The tent is suitable for many awning sizes, as hooks are attached to adjustable straps that can be set flexibly. It is secured to the ground with pegs. The mosquito net tent has 2 side entrances and a large door to the vehicle. (zipper)

Dims.: width 240 cm or 300 cm, depth 230 cm, Height approx. 180 cm - 240 cm. Weight approx. 4.0 kg. Pack size Ø: 30cm, Pack size length: 60cm, No poles necessary.

Included in delivery: Pegs, incl. packing bag.

① **Mosquito Free**

Free 240, width 240 cm **900160** **97,-**

② **Mosquito Free PREMIUM - with sewn-in base**

Free Premium 240, width 240 cm **900164** **119,-**

Free Premium 300, width 300 cm **900165** **141,-**



SELECTION GUIDE AWNING ADAPTERS FOR PANEL VANS & MAXIVANS

Selection guide awnings and adapters









Which adapter fits my van with which awning?

You can see the answer from the tables. Select your vehicle length and height and you will see directly which adapter is possible with which awning type.

Adapters specified are for vehicles without additional attachments (e.g. roof rails).

For special solutions, you may need to use other adapters.



Fiat Ducato - Peugeot Boxer - Citroën Jumper from model year 2007				
	L1 (496 cm)	L2 (541 cm)	L4 (599 cm)	L5 (636 cm)
H1 (225 cm)	 max. 260 cm Thule wall awning with adapter 430631	 max. 300 cm Thule wall awning with adapter 430631	–	–
H2 (252 cm)	 max. 300 cm Thule roof awning with adapter 430092 Thule wall awning with adapter 430637 Fiamma wall awning with adapter 43316	 max. 325 cm Thule roof awning with adapter 430092 Thule wall awning with adapter 430637 Fiamma roof awning with adapter 43716 Fiamma wall awning with adapter 43316	 max. 375 cm Thule roof awning with adapter 430093 Thule wall awning with adapter 430638 Fiamma roof awning with adapter 43716 Fiamma wall awning with adapter 43316	 max. 400 cm Thule roof awning with adapter 430093 Thule wall awning with adapter 430639 Fiamma roof awning with adapter 434641 Fiamma wall awning with adapter 43316
H3 (276 cm)	–	–	 max. 350 cm Thule wall awning with adapter 430632 Fiamma roof awning with adapter 434642	 max. 400 cm Thule wall awning with adapter 430632 Fiamma roof awning with adapter 434642

Mercedes Sprinter from YOC. 2018				
	L1 (527 cm)	L2 (593 cm)	L3 (697 cm)	L4 (737 cm)
H1 (236 cm)	Unfortunately not possible	Unfortunately not possible	–	–
H2 (264 cm)	Fiamma F80s (width 290 cm) with adapter 43459 (UK=433621)	Thule Omnistor 6300 (W325cm) adapter 43041 Fiamma F80s (W320cm) adapter 43459 (UK=433621)	Thule Omnistor 6300 (W375cm) adapter 43041 Fiamma F80s (W370cm) Adapter 43459 (UK=433621)	Thule Omnistor 6300 (W400cm) adapter 43041 Fiamma F80s (W400cm) adapter 43459 (UK=433621)
H3 (285 cm)	–	–	Unfortunately not possible	Unfortunately not possible

Volkswagen Crafter from model year . 2017 - MAN TGE			
	L2 (599 cm)	L3 (684 cm)	L4 (739 cm)
H1 (236 cm)	Unfortunately not possible	–	–
H2 (259 cm)	Thule Omnistor 6300 (width 325 cm) with Adapter 43048 (UK=43055)	Thule Omnistor 6300 (width 400 cm) with Adapter 43048 (UK=43055)	Thule Omnistor 6300 (width 450 cm) with Adapter 43048 (UK=43055)
H3 (280 cm)	–	Fiamma F80s (width 320 cm) with adapter 434592 (UK=44490)	Unfortunately not possible



Mercedes Sprinter YOC. 06-18 / VW Crafter YOC. 06-17				
	L1 (525 cm)	L2 (591 cm)	L3 (695 cm)	L4 (735 cm)
H1 (250 cm)	Unfortunately not possible	Unfortunately not possible	–	–
H2 (280 cm)	Unfortunately not possible	Thule roof awning with adapter 43041 Fiamma roof awning with adapter 43459 (UK=433621)	Thule roof awning with adapter 43041 Fiamma roof awning with adapter 43459 (UK=433621)	Thule roof awning with adapter 43041 Fiamma roof awning with adapter 43159 (UK=433621)
H3 (305 cm)	–	Unfortunately not possible	Fiamma wall awning with adapter 43477	Fiamma wall awning with adapter 43477

Renault Master - Opel Movano from YOC. 2010				
	L1 (505 cm)	L2 (555 cm)	L3 (620 cm)	L4 (685 cm)
H1 (231 cm)	Unfortunately not possible	–	–	–
H2 (251 cm)	Unfortunately not possible	Thule roof awning with adapter 426780 Fiamma roof awning with adapter 434581	Thule roof awning with adapter 426780 Fiamma roof awning with adapter 434581	Thule roof awning with adapter 426780
H3 (278 cm)	–	Thule wall awning with adapter 430630	Thule wall awning with adapter 430630	Thule wall awning with adapter 430630



Roof awnings for Fiat Ducato, Peugeot Boxer, Citroën Jumper from YOC.





Vehicle length 496 cm - short wheelbase (300 cm)

Height H2 (app. 252 cm)	THULE[®] Omnistor 6300			
	Width 300 cm, Extension 250 cm, Weight 23,0 kg			
				
	Mystic gray		Sapphire blue	
Housing White	428301	428311	1100,-	1100,-
Housing Black	428340		1128,-	—
Accessories needed	Adapter set	430092	217,-	
	Sealing tape	43292	57,80	
	Adhesive Sikaflex	294111	21,80	



Vehicle length 541 cm - med. wheelbase (345 cm)

Height H2 (app. 252 cm)	FIAMMA F80s		THULE[®] 6300 VAN set		
	Width 320 cm, Extension 250 cm, Weight 29.0 kg		Width 325 cm, Extension 250 cm, weight 24.0 kg		
					
	Royal Grey		Royal Blue		Mystic gray
Housing White	436261	436268	428000	1171,-	1172,-
				1444,-	
Housing silver	436275	436282	428072	1199,-	1199,-
				1471,-	
Housing Black	436289	—	428075	1199,-	1471,-
Accessories needed	Adapter set 3-piece incl. sealing tape		Including adapter and sealing foam.		
				43716	153,-
	Adhesive		Without glue.		
		294111	21,80		



Vehicle length 599 cm - long wheelbase (403 cm)

Height H2 (app. 252 cm)	FIAMMA F80s		THULE[®] 6300 VAN set		
	Width 370 cm, Extension 250 cm, Weight 32.0 kg		Width 375 cm, Extension 250 cm, weight 27.5 kg		
					
	Royal Grey		Royal Blue		Mystic gray
Housing White	436263	436270	428001	1243,-	1243,-
				1498,-	
Housing silver	436277	436284	428073	1262,-	1262,-
				1525,-	
Housing Black	436291	—	428076	1262,-	1525,-
Accessories needed	Adapter set 3-piece incl. sealing tape		Including adapter & sealing foam.		
				43716	153,-
	Adhesive		Without glue.		
		294111	21,80		

Vehicle length 636 cm - long wheelbase (403 cm)

Height H2 (app. 252 cm)	FIAMMA F80s		THULE[®] 6300 VAN set		
	Width 400 cm, Extension 250 cm, Weight 34,0 kg		Width 400 cm, Extension 250 cm, weight 29.0 kg		
					
	Royal Grey		Royal Blue		Mystic gray
Housing White	436264	436271	428002	1279,-	1279,-
				1542,-	
Housing silver	436278	436285	428074	1316,-	1316,-
				1569,-	
Housing Black	436292	—	428077	1316,-	1569,-
Accessories needed	Adapter set 3-piece incl. sealing tape		Including adapter and sealing foam.		
				43716	153,-
	Adhesive		Without glue.		
		294111	21,80		

Vehicle length 636 cm - long wheelbase (403 cm)

Height H3 (app. 276 cm)	FIAMMA F80s			
	Width 400 cm, extension 250 cm, weight 34.0 kg			
				
	Royal Grey		Royal Blue	
Housing White	436264	436271	1279,-	1279,-
Housing silver	436278	436285	1316,-	1316,-
Housing Black	436292	—	1316,-	
Accessories needed	Adapter set	434642	160,-	
	Sealing tape	434851	51,10	
	Adhesive Sikaflex	294111	21,80	



Alternatively, on vehicles with height H3, a Side wall awning can be installed. For example a Thule Omnistor 5200 w/ adapter or a Fiamma F45 with adapter.

AWNING & ADAPTER ASSIGNMENT FOR CAMPER AND VANS

Volkswagen T6.1 / T6 / T5						
Vehicle version	Vehicle length short (489 cm)			Vehicle length long (529 cm)		
Transporter / Multivan / Caravelle with standard flat roof WITHOUT C-rail on the roof	Fiamma F40	(270 cm)	With adapter 440530 (UK=440531)	Fiamma F40	(270 cm)	With adapter 440530 (UK=440531)
	Fiamma F43	(270 cm)	With adapter 440707 (UK=440708)	Fiamma F43	(300 cm)	With adapter 440707 (UK=440708)
	Fiamma F45	(260 cm)	With adapter E4631 (UK=E4830)	Fiamma F45	(260 cm)	With adapter E4631 (UK=E4830)
	Fiamma F35	(270 cm)	With adapter 433403 (UK=433404)	Fiamma F35	(270 cm)	With adapter 433403 (UK=433404)
	Thule 4200/5200	(260 cm)	With adapter 426702 (UK=426703)			
	Thule 3200	(270 cm)	With adapter 42690 (UK=42696)			
Transporter / Multivan / Caravelle with standard flat roof WITH C-rail on the roof	Fiamma F40	(270 cm)	With adapter 440618 (also UK)	Fiamma F40	(270 cm)	With adapter 440618 (also UK)
	Fiamma F43	(270 cm)	With adapter 440716 (UK=440717)	Fiamma F43	(300 cm)	With adapter 440716 (UK=440717)
	Fiamma F45	(260 cm)	Set 4376730 (silver) incl. adapter (UK=4376740)	Fiamma F45	(300 cm)	Set E46270 (silver) incl. adapter (UK=4376742)
	Fiamma F45	(260 cm)	Set 4376780 (black) incl. adapter (UK=4376782)	Fiamma F45	(300 cm)	Set E10168 (black) incl. adapter (UK=4376783)
	Fiamma F35	(270 cm)	With adapter 43340	Fiamma F35	(300 cm)	With adapter 43340
	Thule 5102	(260 cm)	With adapter 426716 (UK=426717)			
With pop-up roof, WITHOUT side rail	Thule 4200 / 5200	(260 cm)	With adapter 426702 (UK=426703)	Thule 4200/5200	(300 cm)	With adapter 426702 (UK=426703)
With REIMO Multirail - Also with pop-top roof	Fiamma F43	(270 cm)	With adapter 440534			
	Fiamma F45	(260 cm)	With adapter 440534 or 426768	Fiamma F45	(300 cm)	With adapter 426768
	Fiamma F35	(270 cm)	With adapter 440533 or 426768 (UK=440533)	Fiamma F35	(270 cm)	With adapter 426768
	Thule 4200	(260 cm)	With adapter 436704 (UK=426705)	Thule 4200	(300 cm)	With adapter 426706 (UK=436707)
	Thule 3200	(270 cm)	With adapter 42691 (UK=42697)	Thule 3200	(300 cm)	With adapter 426911 (UK=426971)
With Brandrup Top-Rail - Also with pop-top roof	Fiamma F43	(270 cm)	With adapter 440525			
	Fiamma F45	(260 cm)	With adapter 440525			
	Fiamma F35	(270 cm)	With adapter 440523 (also UK)			
	Thule 4200 / 5200	(260 cm)	With adapter 43025			
VW California WITH original VW side rail	Fiamma F43	(270 cm)	With adapter 440714			
	Fiamma F45	(260 cm)	Set 4376709 (white) incl. adapter			
	Fiamma F45	(260 cm)	Set 4379710 (silver) incl. adapter			
	Fiamma F45	(260 cm)	Set 4376760 (black) incl. adapter			
	Fiamma F35	(270 cm)	With adapter 433401			

Renault Trafic 3 from 2014, Nissan NV300 / Primastar from 2014, Opel Vivaro B 2014-2019, Fiat Talento 2016-2021						
Vehicle version	Vehicle length L1 (500 cm)			Vehicle length L2 (540 cm)		
Box and station wagon	Fiamma F40	(270 cm)	With adapter 44349	Fiamma F40	(270 cm)	With adapter 44338
	Fiamma F43	(270 cm)	With adapter 440712	Fiamma F43	(300 cm)	With adapter 440712
	Fiamma F45	(230 cm)	With adapter 433132	Fiamma F45	(260 cm)	With adapter 433133
	Fiamma F35	(220 cm)	With adapter 433132	Fiamma F35	(250 / 270 cm)	With adapter 433132
	Thule 4200/5200	(230 cm)	With adapter 43105 (also UK)			
	Thule 3200	(230 cm)	With adapter 42698 (also UK)	Thule 3200	(250 cm)	With adapter 42695 (also UK)

Citroën Spacetourer/Jumpy 3, Peugeot Traveller/Expert 3, (all from '16), Opel Vivaro C/Zafira Life (all from '19), Fiat Scudo 3/Ulysse (all from '21)

Vehicle version	Vehicle length 495 cm		
Also Pössl Campster with pop-up roof	Fiamma F40	(270 cm)	With adapter 443371
	Fiamma F43	(270 cm)	With adapter 440715
	Fiamma F45	(260 cm)	Set 437680 (white) incl. Adapter
	Fiamma F45	(260 cm)	Set 437681 (black) incl. adapter
	Fiamma F35	(250 / 270 cm)	With adapter 44329
	Thule 4200	(260 cm)	With adapter 426708 (UK=426709)
	Thule 4200	(260 cm)	With adapter 426778 (UK=426779)
	Thule 3200	(270 cm)	With adapter 42693 (UK=42699)

Mercedes Vito from 2014

Vehicle version	Vehicle length long (514 cm)		
W447	Fiamma F40	(270 cm)	With adapter 44337
	Fiamma F35	(250 / 270 cm)	With adapter 433412
W447 with REIMO Multirail - Also with REIMO pop-top roof	Thule 4200	(260 cm)	With adapter 426766
W447 with SCA pop-up roof 152	Thule 4200/5200	(260 cm)	With adapter 426713
Marco Polo with manual pop-top roof	Fiamma F43	(270 cm)	With adapter 443413
	Fiamma F45	(260 cm)	With adapter 433413
	Fiamma F35	(250 / 270 cm)	With adapter 433413
Jule Verne	Fiamma F35	(250 / 270 cm)	With adapter 433414

Ford Transit Custom

Vehicle version	Vehicle length L1 (497 cm)			Vehicle length L2 (534 cm)		
Transit Custom / Tourneo Custom from 2012	Fiamma F40	(270 cm)	With adapter 44336 (UK=443000)	Fiamma F40	(270 cm)	With adapter 44339
	Fiamma F43	(270 cm)	With adapter 440602 (UK=4406039)			
	Fiamma F45	(260 cm)	With adapter 43434 (UK=436259)			
	Fiamma F35	(250 / 270 cm)	With adapter 43434 (UK=436259)			
	Thule 4200	(260 cm)	With adapter 426710 (UK=426711)			
	Thule 3200	(270 cm)	With adapter 42694 (UK=42679)			
Transit Custom Nugget w/ pop-top roof from 2015	Fiamma F43	(270 cm)	With adapter 434563			
	Fiamma F45	(260 cm)	With adapter 434563			
Transit Nugget Plus with high roof from 2012				Fiamma F43	(270 cm)	With adapter 434561
				Fiamma F45	(260 cm)	With adapter 434561
				Thule 4200/5200	(260 cm)	With adapter 430600
Cap Coast from 2018	Fiamma F35	(220 cm)	With adapter 44335			
Cap Land / Cap Fun 2015-2018				Fiamma F35	(250 cm)	With adapter 433416
Cap Land / Cap Fun from 2019				Fiamma F35	(250 cm)	With adapter 434335

The company Fiamma is an Italian camping accessories manufacturer with a 75-year tradition. As an innovative company Fiamma holds over 100 patents in Europe, USA, Japan, Taiwan and Australia. The program includes awnings for wall, roof and keder rail mounting. Rich accessories, such as awnings and other products for motorhomes and caravans, allow useful extensions. Italian design is evident in all products and offers great looks in addition to functionality.

Different types of awnings



Roof awning Fiamma F80S

Widths: 290 - 450 cm
 Excerpt: up to 250 cm
 Cloth colors: Royal Grey, Royal Blue
 Housing colors: Polar White, Titanium, Deep Black



Roof awning Fiamma F80L

Widths: 450 - 600 cm
 Excerpt: up to 275 cm
 Cloth colors: Royal Grey, Royal Blue
 Housing colors: Polar White, Titanium, Deep Black



Roof awning Fiamma F40 VAN

Widths: 210 + 270 cm
 Excerpt: until 225 cm
 Cloth colors: Royal Grey
 Housing colors: Deep Black



Wall awning Fiamma F45S

Widths: 260 - 450 cm
 Excerpt: up to 250 cm
 Cloth colors: Royal Grey, Royal Blue
 Housing colors: Polar White, Titanium, Deep Black



Wall awning Fiamma F45L

Widths: 450 - 550 cm
 Excerpt: up to 250 cm
 Cloth colors: Royal Grey, Royal Blue
 Housing colors: Polar White, Titanium, Deep Black



Fiamma F43 VAN wall awning

Widths: 270 + 300 cm
 Excerpt: up to 250 cm
 Cloth colors: Royal Grey
 Housing colors: Deep Black



Wall awning Fiamma F35 PRO

Widths: 180 - 300 cm
 Excerpt: until 225 cm
 Cloth colors: Royal Grey, Royal Blue
 Housing colors: Titanium, Deep Black



Special awning Fiamma SlideOut

Widths: 200 - 280 cm
 Excerpt: up to 100 cm
 Cloth colors: Royal Grey
 Housing colors: Polar White



Case awning Fiamma Caravanstore

Widths: 190 - 550 cm
 Excerpt: up to 250 cm
 Cloth colors: Royal Grey, Royal Blue
 Lining colors: Light gray, black

Housing colors



POLAR WHITE



TITANIUM



DEEP BLACK

Cloth colors



ROYAL GREY



ROYAL BLUE

Fiamma F80S – Sturdy Awning with aluminum end caps



Preparation for LED lighting

3 keder rails in the front profile

Ideal for Sprinter, VW Crafter, Ducato, Boxer and Jumper.

Fiamma F80S with triple keder rail in the front profile

Type	290	320	340	370	400	425	450
For Ducato H2 from YOC. '07	Vehicle length 496 cm	Vehicle length 541 cm		Vehicle length 599 cm	Vehicle length 636 cm		
For Ducato H2 until YOC. '07	Wheelbase 320 cm		Wheelbase 370 cm				
Awning width A	290 cm	320 cm	340 cm	370 cm	400 cm	425 cm	450 cm
Cloth width B	278 cm	308 cm	328 cm	358 cm	388 cm	412 cm	431 cm
Extract C	200 cm	250 cm	250 cm	250 cm	250 cm	250 cm	250 cm
Weight	27,0 kg	29,0 kg	30,0 kg	32,0 kg	34,0 kg	35,0 kg	36,5 kg

Housing Polar White

Royal Grey	436260	436261	436262	436263	436264	436265	436266
Royal Blue	436267	436268	436269	436270	436271	436272	436273
Price	1044,-	1171,-	1190,-	1243,-	1279,-	1352,-	1352,-

Case titanium

Royal Grey	436274	436275	436276	436277	436278	436279	436280
Royal Blue	436281	436282	436283	436284	436285	436286	436287
Price	1072,-	1199,-	1217,-	1262,-	1316,-	1387,-	1387,-

Case Deep Black

Royal Grey	436288	436289	436290	436291	436292	436293	436294
Price	1072,-	1199,-	1217,-	1262,-	1316,-	1387,-	1387,-

The compact roof awning with front keder profile and aluminum end caps

- Extension up to 2.50 m, width up to 4.50 m
- Slim aluminum housing and end caps
- Preparation for LED light strips on front panel and housing
- Open and close with crank, no slipping, safe hooking and unhooking
- Space-saving mounting on the vehicle roof
- 12 volt motor can be retrofitted
- Mounting adapter suitable for many different types of vehicles

Accessories for Fiamma F80S:

Fiamma mounting adapter (compulsory)	Page 138-140
Fiamma awning blinds	Page 141-142
Fiamma front and side walls	Page 158-159
Fiamma tie rods	Page 160
Fiamma LED strips	Page 188

Telescopic Rafter Arm

Additional tensioning rod for F80S. For more stability and greater resistance to wind. Integrated into the awning arms, they can be used as required. When unfolded, they hook into front profile. **440584** **55,60**



Scope of delivery Fiamma F80S:

Awning crank, support foot attachment to wall, pegs. From awning width 400 cm incl. alu tensioning rod.

Fiamma F80L – Maximum extension up to 275 cm



Preparation for LED lighting



Dual Shock Absorber

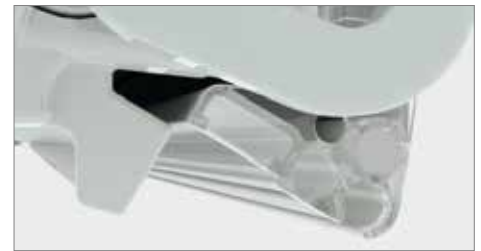

3 keder rails in the front profile

Fiamma F80L w/ triple keder rail in front profile				
Type	450	500	550	600
Awning width A	454 cm	497 cm	547 cm	597 cm
Cloth width B	438 cm	480 cm	530 cm	580 cm
Extract C	275 cm	275 cm	275 cm	275 cm
Weight	43,8 kg	46,5 kg	50,0 kg	54,5 kg

Housing Polar White				
Royal Grey	436014	436019	436024	436029
Royal Blue	436013	436018	436023	436028
Price	1748,-	1900,-	2081,-	2252,-

Case titanium				
Royal Grey	436016	436021	436026	436031
Royal Blue	436015	436020	436025	436030
Price	1821,-	2009,-	2179,-	2343,-

Case Deep Black				
Royal Grey	436017	436022	436027	436032
Price	1821,-	2009,-	2179,-	2343,-

Scope of delivery Fiamma F80S:

Awning crank, support foot attachment to wall, pegs.



The compact roof awning with front keder profile and aluminum end caps

- Length from 450 to 600 cm
- Extension 275 cm
- Rain Guard as standard
- 3 keder rails in the front profile
- Preparation for LED lighting

New awning F80L w/ roof mounting & winch, which is particularly suitable for large vehicles. It provides plenty of space in front of camper thanks to the large extension of 275 cm. Available in 4 lengths: from 450 to 600 cm.

Accessories for Fiamma F80L:

Fiamma mounting adapter (compulsory)	Page 138-140
Fiamma awning blinds	Page 141-142
Fiamma front and side walls	Page 158-159
Fiamma tie rods	Page 160
Fiamma LED strips	Page 188

Telescopic Rafter Arm



Additional tensioning rod for F80L. For more stability and greater resistance to wind. Integrated into the awning arms, they can be used as required. When unfolded, they are hooked into front profile.

440585

61,10



ADAPTER FOR F80S AND F80L

Box van

For high roof H2

Kit Skyroof for Fiat Ducato, Peugeot Boxer, Citroën Jumper RHD + LHD. From YOC. 7/06, 3-pcs. (3x35cm).
440517 183,-

For high roof H2

Flat adapter kit for Fiat Ducato, Peugeot Boxer, Citroën Jumper or Opel Movano from 2021 onwards without front panoramic roof hood
From YOC. 7/06, Only for F80s. **Right Hand Drive + Left Hand Drive**

For L2 / L4 and awning width up to 370 cm, 3-piece . (1x20cm/1x15cm/1x12cm).
Adapter Kit Silver 440527 186,-
Adapter Kit Black 440528 224,-

For L5 and awning width 400 cm. 3-piece . (2x26cm/1x12cm)
Adapter Kit Silver 440526 221,-

KIT consisting of:
Brackets with Rain Guard Slim Kit 450 cm and Kit Cover.

For high roof H2

Fiat Ducato, Peugeot Boxer, Citroën Jumper
From YOC. 7/06, for L2 / L4 and awnings up to 370 cm and L5 up to 400 cm. 3-piece . (1x20cm/1x15cm/1x12cm).
Right Hand Drive + Left Hand Drive
Silver 43716 153,-
Black 43717 210,-

Also for Opel Movano from 2021

For high roof H2

Also for Opel Movano from 2021

Fiat Ducato, Peugeot Boxer, Citroën Jumper
From YOC. 7/06, for L5 and Awning width 400 cm.
3-piece. 434641 190,-

For high roof H2

Fiat Ducato, Peugeot Boxer, Citroën Jumper
from YOC. 7/06, for L4 / L5 and Super high roof H3.
3-piece. 434642 160,-

For high roof H2

Fiat Ducato, Peugeot Boxer, Citroën Jumper
from YOC. 94-6/06
2-piece. 43478 118,-

For high roof H3

VW Crafter from 17, MAN TGE
with Roof Rail, specified awning width 320 cm
434591 331,-

For high roof H3

VW Crafter, MAN TGE from 17
L3 / H3, w/o. Roof Rail, specified awning width 320 cm
3 holders (2 x 20 cm, 1 x 32 cm)
434592 396,-
UK= 44490 396,-

For high roof H2

Kit Fiat Ducato Smart Clamp System
For mounting the awning F80s on Thule roof rack system Smart Clamp.
For L2 / L4 / L5. 3 holders (2x20cm/1x12cm)
Set 43505 162,-

For high roof H2

Ford Transit from 14
H2/L2, 290cm
440616 239,-
H2/L3, 320cm
440617 239,-

For high roof H2

MB Sprinter from 07, VW Crafter 07 - 17
3 holders each 53, 60 and 12 cm
43459 177,-
UK version 433621 177,-

For high roof H2

Mercedes Sprinter 07 - 18 with Roof Rail
3 holders (2 x 40 cm, 1 x 12 cm)
43471 153,-

For high roof H2

Renault Master, Opel Movano from Year 2010
3 Holder
434581 172,-

For high roof H2

Renault Master, Opel Movano Year 2006-2010
3 holders, 2 x 29 cm, 1 x 12 cm
43458 153,-

For high roof H2

Ford Transit from 14
H3/L3, 320cm
440523 239,-
H3/L4, 400cm
43450 425,-
H3/L3, 320cm, UK version
440614 239,-
H3/L4, 400cm, UK version
440615 425,-

For FIAMMA F80S and F80L

Railing incl. Awning adapter

- Mounting on the original points
- Mounting without drilling
- With 4 crossbars
- Load capacity 100 kg

Roof rail/rack incl. awning mounting adapter for Fiat Ducato, Peugeot Boxer & Citroën Jumper from 07. For mounting the awning on the right-hand side of the vehicle. For Ducato from 2007
41099 857,-

For high roof H2

Iveco Daily
Bonding necessary
2 holders à 15 cm 1 holder à 20 cm
SA831 126,-

Awning package F80s for Fiat Ducato

F80s awning package for Fiat Ducato, Peugeot Boxer, Citroën Jumper or Opel Movano from 2021
Case in Deep Black, Cloth in Royal Grey

Awning version F80s in lengths 320, 370 and 400 in the Deep Black version. Extension 250 cm.

Scope of delivery:

- Awning F80s in Deep Black finish
- Adapter in black (370 cm) or silver (400 cm) version - Kit Fiat Ducato / Citroën Jumper / Peugeot Boxer / Opel Movano from 2021 - Low Profile ≥ 2006 - H2
- Black gasket to protect against water

320 cm, 29 kg	440457	1371,-
370 cm, 32 kg	440458	1441,-
400 cm, 34 kg	440459	1500,-

Adapter F80 and F65 for motorhomes

For adapter 43716 + 43717

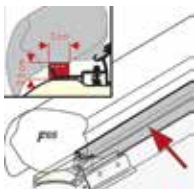

RainGuard Kit F65/F65S

Protects against water penetration between the awning and the vehicle wall.

450 cm	434851	51,10
--------	---------------	--------------

Adapter LMC - TEC

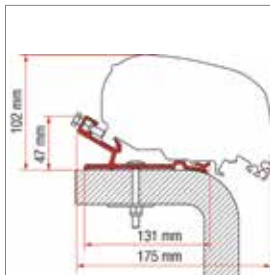
450 cm	436243	354,-
500 cm	436244	378,-
550 cm	436245	409,-
600 cm	436246	440,-

Adapter Hymer

550 cm	436247	423,-
600 cm	436248	423,-

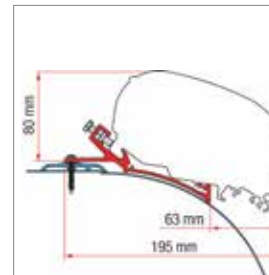
Kit Laika Kreos 21

4x15 cm	436249	108,-
---------	---------------	--------------

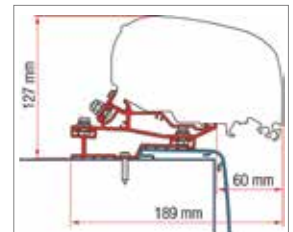
Adapter Rapido C Line

340 cm	436250	344,-
400 cm	436251	379,-
425 cm	436252	391,-
450 cm	436253	402,-



Adapter Rapido C55i C86i

500 cm	440516	417,-
--------	---------------	--------------

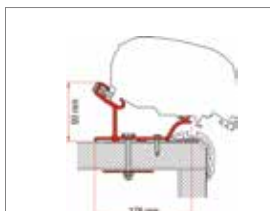

LMC - TEC

LMC Liberty TI one-piece profile bar, bonding necessary

370 cm	SA852	299,-
400 cm	E2589	309,-

Kit Carthago Malibu

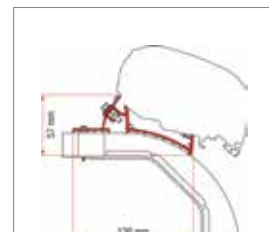
340 cm	44485	316,-
400 cm	44486	356,-
450 cm	44487	423,-
490 cm	44488	435,-

Arca Mobilvetta K-Yacht

3 holder à 15 cm	44481	118,-
------------------	--------------	--------------

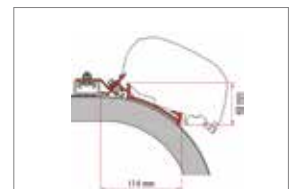
Rapido Distinction

400 cm	44482	334,-
450 cm	44483	365,-
490 cm	44484	365,-
600 cm	436254	435,-

Hymer adapter

one piece profile bar		
320 cm	44401	271,-
370 cm	44402	286,-
400 cm	44403	302,-
450 cm	44404	351,-
490 cm	44400	359,-

Carthago Chic

one-piece profile bar, Bonding necessary		
450 cm	SA285	361,-
400 cm	E1106	301,-
490 cm	E10083	368,-

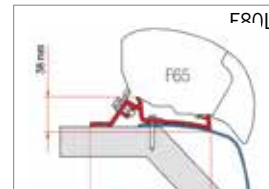

Laika Rexosline/ Ecovip Laola Kreos 2009-2021

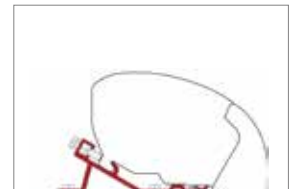
Bonding necessary		
4 holders à 15 cm	SA850	180,-
500 cm	440604	428,-

Kit standard

3 holders à 20 cm	43473	124,-
-------------------	--------------	--------------

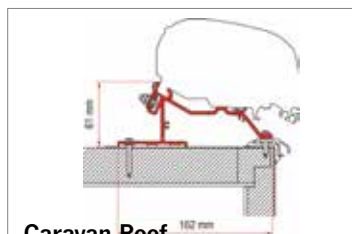
CaravanAdapter for F65L + F80L & F80s



Caravan Roof

For Dethleffs, Fendt, LMC, Trigano and others.

290 cm	44493	292,-
320 cm	44494	292,-
340 cm	44496	307,-
370 cm	44497	350,-
400 cm	44498	351,-
425 cm	44499	383,-
450 cm	44474	402,-
500 cm	44306	429,-

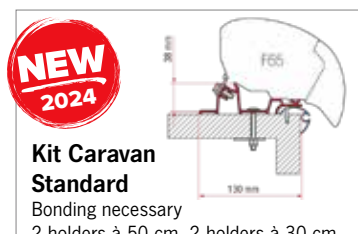

NEW 2024

Kit Caravan Standard

Bonding necessary
2 holders à 50 cm, 2 holders à 30 cm

320 cm	440605	241,-
340 cm	440606	241,-
370 cm	440607	278,-
400 cm	440608	278,-
425 cm	440609	334,-
450 cm	440610	334,-
500 cm	440611	334,-
550 cm	440612	394,-
600 cm	440613	394,-



Mounting kit for LMC caravans

4 washers, bolts and nuts
43506 9,85

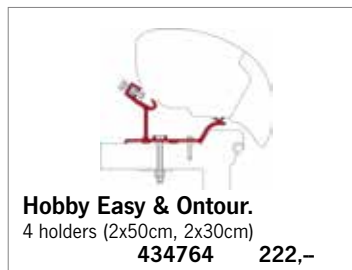

Hobby Easy & Outour.

4 holders (2x50cm, 2x30cm)
434764 222,-

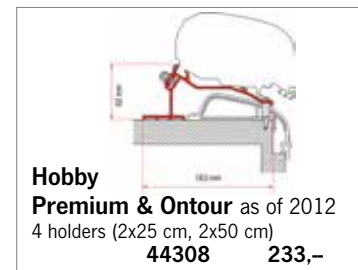

Hobby Premium & Outour as of 2012

4 holders (2x25 cm, 2x50 cm)
44308 233,-

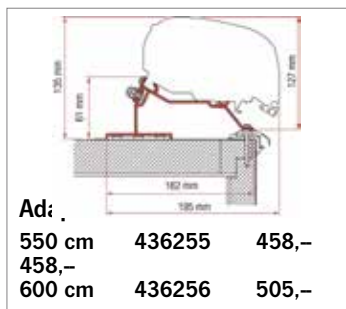

Ad: .
550 cm 436255 458,-
458,-
600 cm 436256 505,-

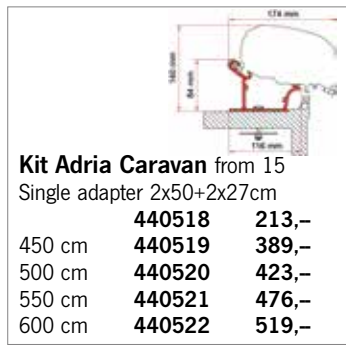

Kit Adria Caravan from 15

Single adapter 2x50+2x27cm
440518 213,-
450 cm 440519 389,-
500 cm 440520 423,-
550 cm 440521 476,-
600 cm 440522 519,-

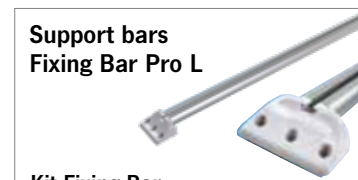

Support bars Fixing Bar Pro L

Kit Fixing Bar

Rail with 2 white painted End/mounting pieces.
1 piece **41114 83,40**



Kit Fixing Bar

For mounting on Fiamma Fixing Bar Pro L (see above). Use 2 fixing bars up to 3.50 m and 3 pieces from 4 m awning width.
43470 135,-

Motor kits F80S and F65S

12 V Motor Kit Compact for F80s
For retrofitting. Increases the width of the awning by 12 cm. With switch for electric Connection and emergency crank.

Polar White	436295	556,-
Titanium	436296	556,-
Deep Black	436297	556,-

Upgrade Kit Advanced for Compact F80s engine kit
436405 278,-

Motor + switch

12V

12 V Motor Kit Plus for F80s

Remote control with infrared remote control and wall control. The control unit can be used to automatically tension the awning cloth when it is opened; opening and closing can also be done via the automatic "One Touch" system.

Polar White	436298	631,-
Titanium	436299	631,-
Deep Black	436300	631,-

Motor + switch + remote control

12 V Motor Kit Advanced for F80s

Operate your awning conveniently from your smartphone. Thanks to practical Fiamma app (for Android or iOS systems) you can control opening & closing of the awning F80s from your mobile.

Polar White	43676	741,-
Titanium	43677	741,-
Deep Black	43678	741,-

Motor + Switch + App

Motor kits F80L and F65L

12 V Motor Kit Compact for F80L
For retrofitting. Increases the width of the awning by 12 cm. With switch for electric Connection and emergency crank. Weight 2.4 kg.

Polar White	440461	602,-
Titanium	440462	602,-
Deep Black	440460	602,-

Motor + switch

12V

12 V Motor Kit Advanced for F80L

Operate your awning conveniently from your smartphone. Thanks to practical Fiamma app (for Android or iOS systems) you can control opening & closing of awning F80L from your mobile. Weight 2.5 kg.

Polar White	440464	787,-
Titanium	440465	787,-
Deep Black	440463	787,-

Motor + Switch + App

Motor Kit Compact F65L

- Smaller dimensions
- Constructive simplicity
- Reliability
- excellent performance

Motor Kit Compact for the awning F65L.

Polar White	436305	602,-
Titanium	436306	602,-
Deep Black	436307	602,-

Motor + switch

Fiamma Privacy Room

- With **FAST CLIP** system for windproof connection between awning fabric & side panels
- Zippers between front and side wall
- Door usable left or right

Scope of delivery

Front part with door & window, two side walls with window and mosquito net, clip system profile, pack bag, curtains.

Accessories

Curtains, 1 pair	Dark Grey	
440486	84,-	
Curtains, 3 pair	Dark Grey	
440487	208,-	
Windshields	Page 185	



Fiamma Privacy Room
Awning blinds for Fiamma F80, F80L and F65

Robust Awning for F65/F80 with extension C = 250 cm

* This set includes a kit with 2 x 6 magnets incl., which ensure adhesion to Vehicle .



NEW
2024

** With additional magnetic attachment.

** For Mercedes Sprinter, Volkswagen Crafter, Fiat Ducato, CitroënJumper or Peugeot Boxer H3, the Fast Clip Light aluminum linkage is incl. in scope of delivery.

*** Specified model for vehicles w/ straight wall, height from floor 245 - 280 cm.

Basic model	For Ducato >06*		For panel van H3**		Alcove + semi-integrated***	
	Small/Van (W = 245 cm)		Medium (B = 245-280 cm)		Large (B = 245-280 cm)	
A = 300 cm	440485	1585,-	440570	1830,-	435042	1804,-

Extension to awning width	Front panels	Front extension sets to adjust the width					
		320 cm	K: 20 cm	436620	62,20	436620	62,20
340 cm	M: 40 cm	436621	68,70	436621	68,70	436621	68,70
370 cm	O: 70 cm	436622	88,30	436622	88,30	436622	88,30
400 cm	Q: 100 cm	436623	138,-	436623	138,-	436623	138,-
425 cm	R: 125 cm	436624	169,-	436624	169,-	436624	169,-
450 cm	U: 150 cm	436625	196,-	436625	196,-	436625	196,-

IMPORTANT: Adapter E3616 is required for mounting on the F65s awning.

E3616 33,90



Basic model

Front extension sets

Awning for F80L with extension C = 275 cm

Basic model	XL (B = 245-280 cm, C = 275 cm)		XXL (B = 281-310 cm, C = 275 cm)	
A = 300 cm	435043	1818,-	435044	1930,-

Extension to awning width	Front panels	Front extension sets to adjust the width			
		450 cm	U: 150 cm	436625	196,-
500 cm	W: 200 cm	435313	234,-	435313	234,-
550 cm	W: 200 cm	435313	234,-	435313	234,-
	+ I: 50 cm	435311	68,70	435311	68,70
600 cm	W: 200 cm	435313	234,-	435313	234,-
	+ P: 100 cm	436623	138,-	436623	138,-

Grundmodell
[XL], [XXL]



Fiamma Privacy Room Light

The lightweight awning blinds



Privacy ROOM Light for F80S - Awning without awning

Basic model	Small * (e.g. Ducato >06) A = 300 cm B = 245 cm C = 250 cm	Medium ** (Caravans / motorhomes) A = 300 cm B = 245 - 280 cm C = 250 cm	Large * (H3 panel van) A = 300 cm B = 280 cm C = 250 cm
Weight	14,6 kg	14,8 kg	15,3 kg
itemNo.	440572	440574	440573
Price	1259,-	1372,-	1409,-

- For roof awning F80S
- Consisting of side panels and front
- Material: Polyester
- Mounting side panels with FastClip
- Front window roll up, with mosquito net
- Side windows with blackout and mosquito net
- Incl. Bag Megabag light (140x25x25 cm)
- Incl. Curtains for front windows
- Door usable left and right
- Zippers connect front and side walls

* Small and Large version for panel vans incl. magnet kit, consisting of 2 magnet sets of 6 magnets each.



Extension to A	Front panels	Front extension sets, suitable for all basic models	
320 cm	F: 20 cm	440497	54,50
340 cm	H: 40 cm	440577	58,90
370 cm	N: 70 cm	440578	73,10
400 cm	P: 100 cm	440501	117,-
425 cm	Q: 125 cm	440502	137,-
450 cm	T: 150 cm	440575	168,-

** Version without magnets for vehicles with straight side walls.



Basic model



Front extension sets



H, N



P



Q, T

Scope of delivery basic model:

Front part with window and curtains, 2 side panels, pegs.

Accessories:

Curtains, 1 pair, Dark Grey **440486 84,-**
 Curtains, 3 pairs, Dark Grey **440487 208,-**
 Wind screens: Page 185

The Privacy ROOM Light for wall awnings can be found on page 148



Magic Kit Privacy

Telescopic Reinforcing rods

Reinforce awning supports for awnings tents

Magic Kit Privacy Front Short

for Privacy 260 to 360 & 450	44410	141,-
for Privacy 400, 410 & 440	44411	178,-
for Privacy 500 & 550	44412	201,-
Magic Kit Privacy Side	44413	87,20



Press-rod

Pressure bars

Vertical pole to support the awning Privacy on the wall of the vehicle.

To be ordered separately with Privacy Room Light and Privacy Room CS Light.

E3542 91,60



Door Pole vertical door pole for better support of front wall in door area.

for Fiamma F80S, F80L **440443 58,90**
 for Fiamma F65 **444090 46,90**

Fiamma F45S Wall awning for compact vans



The Awning for motorhomes, caravans and camper vans with 2 piping rails

- Extra-strong, lightweight aluminum housing with aluminum end caps and 2 keder rails
- Maximum shaded area, cloth with diffuse light distribution
- Vinyl cloth printed on both sides with anti-scratch coat as a protective film
- Regulation system for closing the front panel
- Self-locking auto-lock safety mechanism
- Support feet integrated in the front panel
- Special mounting adapters available for various vehicles
- 12 V motor can be retrofitted as an option

Accessories for Fiamma F45S:

Fiamma mounting adapters for special mounting situations Fiamma front and side walls
 Fiamma awnings Fiamma tension rods
 Fiamma sealing rubbers

Page 145-146
 Page 158-159
 Page 147-148
 Page 160
 Page 161

Fiamma F45S with 2 front keder rails

Type	260	300	325	350	375	400	425	450
Awning width A	263 cm	308 cm		348 cm	375 cm	398 cm	423 cm	448 cm
Cloth width B	247 cm	292 cm		331 cm	357 cm	381 cm	406 cm	431 cm
Extract C	200 cm	250 cm	250 cm	250 cm	250 cm	250 cm	250 cm	250 cm
Weight	19,5 kg	23,0 kg	24,0 kg	25,0 kg	26,0 kg	27,0 kg	28,2 kg	29,5 kg

Housing Polar White

Royal Grey	4376217	437687	—	437697	437705	437707	437709	437717
Royal Blue	4376218	437688	—	437698	437710	437708	437711	437718
Price	887,-	977,-	—	1076,-	1135,-	1155,-	1292,-	1292,-

Case titanium

Royal Grey	4376267	437727	—	437737	437745	437747	437755	437757
Royal Blue	4376268	437728	—	437738	437746	437748	437756	437758
Price	916,-	1000,-	—	1096,-	1154,-	1186,-	1316,-	1316,-

Case Deep Black

Royal Grey	4376991	4377001	437713	4377002	437704	437703	437706	437712
Price	916,-	1000,-	1047,-	1096,-	1154,-	1186,-	1316,-	1316,-

Scope of delivery: awning crank, support foot attachment to the wall and pegs. For awning width 400 cm and 450 cm incl. aluminum tensioning rod Rafter.



Reinforced bracket of the support feet.



Rain gutter in the front panel diverts rainwater runoff to the sides.



Dual-shock absorbers on support arms absorb wind movements, e.g., and thus protect awning & vehicle.



Double keder rail to accommodate accessories such as hook set, Tiedown S storm bracing, Sun/Rain Blocker or Privacy Room.



Cable channels integrated into the support arms ensure perfect attachment of accessories such as LED lighting.

Fiamma F45L

Wall awning for compact Vans



Large folding arm awnings with sturdy aluminum end caps and 2 keder rails

- Equipment like F45S
- Widths from 450 cm to 550 cm
- Perfect fabric tension thanks to roller support
- Optionally, a 12 volt motor can be retrofitted

Fiamma F45L with mounting plates for the side wall

Type	450	500	550
Awning width A	452 cm	502 cm	552 cm
Cloth width B	435 cm	485 cm	535 cm
Extract C	250 cm	250 cm	250 cm
Weight	39,0 kg	42,5 kg	46,5 kg

Housing Polar White

Royal Grey	425007	425027	425047
Royal Blue	425008	425028	425048
Price	1613,-	1849,-	2009,-

Case titanium

Royal Grey	425017	425037	425057
Royal Blue	425018	425038	425058
Price	1645,-	1892,-	2044,-

Case Deep Black

Royal Grey	440450	440451	440452
Price	1645,-	1892,-	2044,-

Accessories for Fiamma F45L

Fiamma mounting adapter for special mounting situations	Page 145-146
Fiamma front and side walls	Page 158-159
Fiamma awning PrivacyRoom	Page 147
Fiamma tie rods	Page 160

Scope of delivery of F45L

Awning crank, support foot attachment to the wall and by pegs. For awning width 450 cm to 550 cm, an aluminum tensioning rod Rafter is included.



Awning mounting

Mounting plates are already included in the scope of delivery for the side wall awnings.

These are suitable for mounting awning on a smooth wall surface, e.g. on a motorhome with a sandwich body or on a high roof. However, some manufacturers equip their vehicles w/ raised profile edges or other attachments that make mounting w/ the supplied plates impossible. In this case, an appropriate vehicle adapter can help.

Awning motors for F45S and F45L

- Now new with smaller dimensions
- 12 volt motors for retrofitting
- Emergency operation by hand is possible
- Control unit "Control System" for motor mounting included in scope of delivery

The motor kits for F45S, F45L are mounted on the side of the awning instead of the existing awning gearbox. The Advanced version can be controlled via mobile.

This increases width of awning by 13 cm.

If no power is available, emergency operation by hand crank is still possible.



Motor kit F45L now also in black

Motor Kit Compact



Advanced motor kit



Engine kit F45S Compact Polar White	436308	575,-
Engine kit F45S Compact Titanium	436309	575,-
Engine Kit F45S Compact Deep Black	436310	575,-
Engine kit F45S Compact Polar White RHD*	436311	575,-
Motor kit F45S Advanced Polar White	440467	779,-
Engine kit F45S Advanced Titanium	440468	779,-
Motor kit F45S Advanced Deep Black	440466	779,-
Motor kit F45L Compact Polar White	436312	602,-
Engine kit F45L Compact Titanium	436313	602,-
Motor kit F45L Compact Deep Black	440586	602,-
Motor kit F45L Advanced Polar White	436314	787,-
Engine kit F45L Advanced Titanium	436315	787,-
Motor kit F45L Advanced Deep Black	440587	787,-

* Right Hand Drive Version



The scope of delivery of all motor kits also includes a control unit.

F45 wall mounting adapter for panel vans and buses

NEW 2024

VW T5/T6 sleeper roof
For vehicles with pop-up roof. 2 holders à 21.5 cm.
right **440599 117,-**
left, (UK) **440601 117,-**

Bonding necessary.

VW T5/T6
Transporter or Multivan without C-profile.
2 silver holders 21.5 cm:
right **E4631 120,-**
left, (UK) **E4830 120,-**
2 black holders 21.5 cm:
right **440705 138,-**
left, (UK) **440706 138,-**

NEW 2024

VW T5/T6
Screwing into the existing mounting points, no gluing necessary. Not for C-rail. 2 holders 12 cm each.
E6413 95,40

Multirail adapter
Special adapter for the REIMO Multirail, also for folding sleeping roofs. Black brackets for mounting the F45 to the Multirail. Awning and adapter are removable without affecting the appearance of the vehicle.
ATTENTION: only mountable w/ existing Multirail.

can be used on the left and right

VW T5 / T6 / T6.1
For REIMO Multirail rain gutter. 2 black holders 8 cm each.
440534 139,-

Citroën Spacetourer
and similar to REIMO Multirail. For L2/L3. Removable.
426770 197,-

VW T5 / T6 / T6.1
Mounting on REIMO Multirail. For KR and LR. Removable.
426768 197,-

Westfalia high roofs
For Westfalia high roofs w/ awning preparation. 2 holders 12 cm each.
43483 53,50

VW T4
With Brandrup-Rain gutter or REIMO Multirail. 2 holders à 8 cm
433201 123,-

VW T5/T6
For Brandrup gutter. 2 black holders 12 cm each.
440525 108,-

Ford Transit
Ford Transit from 7/06 w/ standard high roof. 2 holders à 40 cm
43456 91,60

NEW 2024

Ford Transit H3
Ford Transit H3/L3. 2 holders à 25 cm and 1 x 8 cm.
right **440595 200,-**
left, (UK) **440596 200,-**

Ford Custom Nugget
Ford Custom Nugget from 2015, H1/L1 w/ sleeping roof. 2 black holders 8 cm each.
434563 278,-

H2
L1

Ford Custom Nugget
Ford Custom Nugget with high roof. 2 holders à 12 cm
434561 104,-

NEW 2024

Ford Custom
2 holders à 12 cm
right **440602 179,-**
left, (UK) **440603 179,-**

Ducato/Boxer/Jumper
From YOC. 1994 to 6/06 for series high roof, 2 holders à 8 cm. Bonding necessary.
43324 104,-

Ducato/Boxer/Jumper
From YOC. 7/06 for series high roof H2, 2 holders 8 cm each. Bonding necessary.
43316 108,-

Ducato/Boxer/Jumper
From YOC. 7/06 for standard high roof H2 w/ Roof Rail, 3 holders of 12 cm each
44405 104,-

Ducato/Boxer/Jumper
From YOC. 7/06 with Roof Rack, 3 holders 12 cm each
43355 94,90

Ducato/Boxer/Jumper HymerCar and Pössl
For vehicles from YOC. 07 w/ standard high roof H2 & folding sleeping roof. 3 holders 12 cm each
444051 198,-

Also for VW LT until 06 and Fiat Ducato until 94 suitable

Sprinter until 06
For Sprinter with Bj. until 6/06. With holder for the rain gutter. 2 holders à 8 cm
43311 136,-

Sprinter / Crafter
From YOC. 7/06 with high roof. 2 holders à 40 cm
43456 91,60

Sprinter / Crafter
From YOC. 7/06 with high roof H3. Also for Westfalia high roof H3.3 holder à 8 cm
43477 116,-

Mercedes Vito until 2003
For Vito compact w/ original Mercedes roof rack. 2 holders à 14 cm
43317 177,-

L2

MB Marco Polo
Mercedes-Benz Marco Polo from '14. Manual sleeping roof only. 2 holders (1x12 cm/1x13 cm)
433413 272,-

Holder A Holder B

For vans with rain gutter
In set with holder A + B. 2 holders of 8 cm.
43311 136,-

GRP roofs
For gluing. Especially for high roofs of Mercedes, VW, Renault+Opel, 2 Holder à 40 cm
43460 142,-

Traffic/Vivaro until 2015
For wheelbase L1 and L2 with awning F45s 260 cm. 2 holders of 16 cm.
43313 108,-

L1 / L2

Renault Traffic, Opel Vivaro, Fiat Talento as of 2015
2 holders of 16 cm
43313 106,-

F45 Wall mounting adapter for motorhomes & caravans

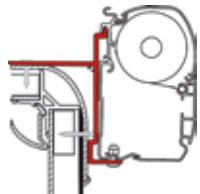

Adria / Bürstner
ADRIA Coral up to 4 m awning length & various Bürstner vehicles. 3 holders à 15 cm / 1 holder à 12 cm
433903 89,40

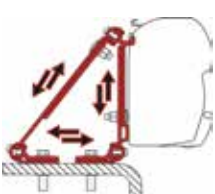

Multi adapter
Multi roof adapter, 1 holder à 8cm
SA691 67,60

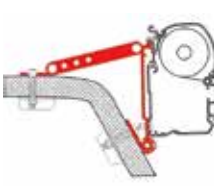

Wall adapter
Universal wall adapter, 3 holders à 8cm
43397 103,-

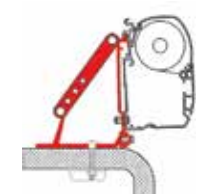

Roof adapter
Universal roof adapter, 3 holders à 8 cm
43389 115,-

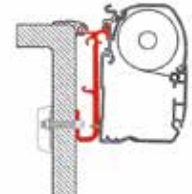

Caravan keder rail
Various mounting options 3 mounting plates à 13 cm
43319 84,-

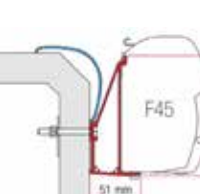

Rapido Series 6 to '24
Adapter rails for Eura and Karman vehicles
350 cm **E1104 363,-**
400 cm **434762 381,-**

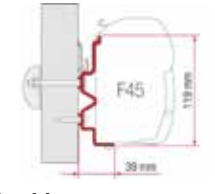

Rapido Series 9dF-9M-10
as of 2011
350 cm **43474 358,-**
400 cm **E1105 390,-**
450 cm **434742 416,-**

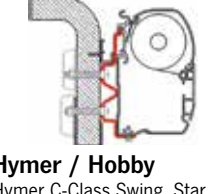

Hymer / Hobby
Hymer C-Class Swing, Star Line, Hobby Van and Caravan 09.
300 cm **43327 240,-**
350 cm **43333 268,-**
400 cm **43336 319,-**
450 cm **433361 336,-**

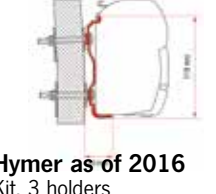

Hymer as of 2016
Kit, 3 holders à 12 cm **44480 111,-**
300 cm **44475 239,-**
350 cm **44476 265,-**
400 cm **44477 289,-**
450 cm **44478 341,-**

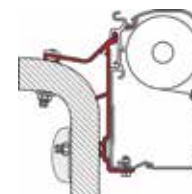

Hymer
Hymer VAN / B2
350 cm **43349 258,-**
400 cm **433410 293,-**
450 cm **433491 357,-**



NEW 2024
Rapido Series 6 from '24
Adapter rails
400 cm **440597 390,-**
500 cm **440598 428,-**

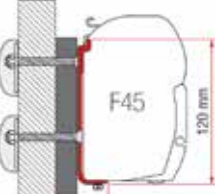

Dethleff's/Globebus
Universal wall adapter, 3 holders 12 cm each
433931 97,10



Roof Rail below
For roof rack
Fits most trusses. For awning mounting are required min. 2 kits needed. 1 holder à 12 cm
43368 161,-

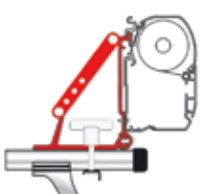

Car adapter top
For mounting on the support tube of the roof rack. 2 piece
43398 113,-

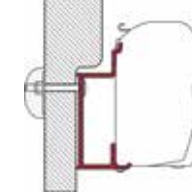

Eura Mobil / Karmann
Adapter rails for Eura and Karman vehicles
350 cm **434571 326,-**
400 cm **SA600 370,-**
450 cm **SA598 402,-**

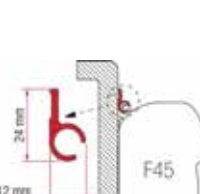

Rail
Length 400 cm
E6019 43,60

Wall bracket for smooth, vertical motorhome and caravan walls



Kit S 120
Single holder 1 holder à 12 cm + accessories.
43481 22,90



Kit S 400 single holder 1 holder à 40 cm + accessories.
43482 44,70



Kit AS 120 holder set 2 holders à 12 cm 1 holder à 8 cm + accessories.
Series at 260-400 cm
43480 53,50



Kit AS 400 holder set 2 holders à 40 cm 1 holder à 12 cm + accessories.
Series at 450-500 cm
434821 111,-



AS 300 Complete rail
300 cm **43335 204,-**



AS 350 Complete rail
350 cm **433351 228,-**



AS 400 Complete rail
400 cm **433352 265,-**



AS 450 Complete rail
450 cm **433353 329,-**

Standard Scope of delivery
for F45S/F45L

- up to 4.00 m width 2 holders à 12 cm + 1 holder à 8 cm.
- 4.50 m width up to 5.00 m width 2 holders à 40 cm + 1 holder à 12 cm
- 5.50 m width 4 holders à 40 cm

Modular fasteners for F45

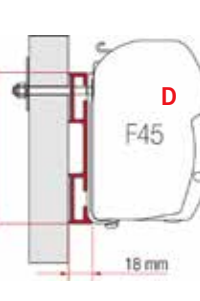

114 mm
18 mm

Ideal for mounting on the high roof

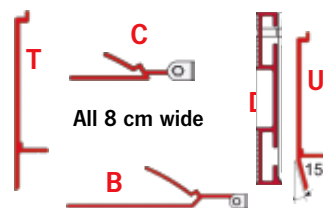
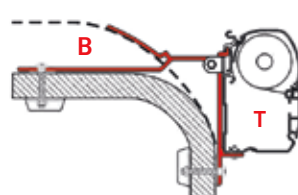
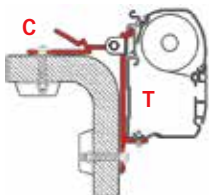
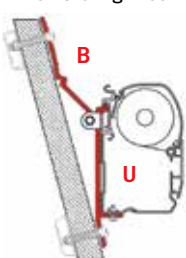

Adapter sets for almost any mounting situation

5 different aluminum profile parts to put together an adapter yourself. The holder parts are 8 cm wide and can be combined with each other (see examples).

T-adapter	43364	18,60
B adapter	43365	36,-
C-Adapter	43367	32,70
D-Adapter	43372	16,40
U-adapter	43373	20,80

The robust Awning

- Consisting of side panels and front
- Material: Vinyl
- Mounting side panels with FastClip
- Front window roll up, with mosquito net
- Side window roll up, with mosquito net
- Incl. Bag Megabag (140 x 27 x 40 cm)
- Incl. Curtains for all windows
- Door usable left and right
- Zippers connect front and side walls
- Also suitable for Omnistor 5002 & 5003 with optional kit Privacy O (E4263)

Scope of delivery basic model: Front part w/ door & window, curtains, two side walls w/ window & mosquito net, clip system profile.

Accessories:

Curtains, 1 pair, Dark Grey	440486	84,-
Curtains, 3 pairs, Dark Grey	440487	208,-
Kit Privacy O	E4263	49,90

for mounting on Thule awning

Wind screens: Page 185

Dimension designations for your Privacy Room basic model

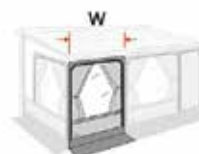
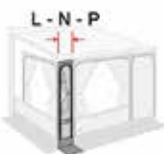
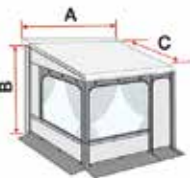

Fiamma Privacy Room



Also for panel vans & buses

Privacy Room for roof awnings can be found on page 141.

Privacy ROOM for F45S and F45L - awning without awning

Basic model		Small (A = 260 cm) Height B = 180 - 220 cm Pull-out C = 200 cm		Medium (A = 300 cm) Height B = 225 - 250 cm Pull-out C = 250 cm		Large (A = 300 cm) Height B = 251 - 280 cm Pull-out C = 250 cm	
		435300	1519,-	435301	1516,-	435302	1538,-
Extension to awning width	Front panels	Front extension sets to increase the width					
300 cm	L: 40 cm	436626	92,70				
325 cm	T: 25 cm			435314	62,20	435314	62,20
350 cm	N: 50 cm			435311	68,70	435311	68,70
375 cm	P: 75 cm			435312	88,30	435312	88,30
400 cm	Q: 100 cm			436623	138,-	436623	138,-
425 cm	R: 125 cm			436624	169,-	436624	169,-
450 cm	U: 150 cm			436625	196,-	436625	196,-
500 cm	W: 200 cm			435313	234,-	435313	234,-
550 cm	N+W 50+200 cm					+ 435311 435313	68,70 234,-

The Quick-assembly awning blind

- One-piece, underhung tent made of side panels, front and roof
- Material: Polyester Ripstop
- Mounting with transverse frame
- Front window fixed, front panel removable
- Side windows with blackout and mosquito net, side walls can be opened
- Incl. Bag Megabag light, for UL 400 with bag Megabag
- Incl. Curtains for front windows

Scope of delivery Tent consisting of roof, front and side walls, mounting kit for Fiamma awnings, cross-rafters, tension straps with pegs and transport bag.

Accessories

Curtains, 1 pair, Dark Grey	440486	84,-
Curtains, 3 pairs, Dark Grey	440487	208,-
Windshields	Page 185	

Fiamma Privacy Ultra Light



Privacy ULTRA Light for F45S and F45L - Awning blinds without awning

Type	Width awning	Mounting height (B) 180-220 cm		Mounting height (B) 230-280 cm	
		Weight	Price	Weight	Price
UL Van 260	260 cm	12,3 kg	43595	1338,-	
UL 300	300 cm, 320 cm			14,2 kg	435950 1389,-
UL 350	350 cm, 370 cm			15,4 kg	435951 1436,-
UL 400	400 cm			16,6 kg	435952 1557,-
UL 450	450 cm			17,8 kg	435953 1606,-

Fiamma Privacy Room Light

The lightweight awning blinds



Privacy ROOM Light for F45S - Awning without awning

Basic model	Small (Van) A = 260 cm B = 180 - 220 cm C = 200 cm	Medium A = 300 cm B = 225 - 250 cm C = 250 cm	Large A = 300 cm B = 251 - 280 cm C = 250 cm
Weight	12,0 kg	14,4 kg	14,7 kg
itemNo.	440494	440495	440496
Price	1149,-	1149,-	1168,-

Extension to A	Front panels	Front extension sets to increase the width					
300 cm	X: 40 cm	440571	58,90				
325 cm	Z: 25 cm			440498	52,40	440498	52,40
350 cm	I: 50 cm			440499	58,90	440499	58,90
375 cm	O: 75 cm			440500	73,10	440500	73,10
400 cm	P: 100 cm			440501	117,-	440501	117,-
425 cm	Q: 125 cm			440502	137,-	440502	137,-
450 cm	T: 150 cm			440575	168,-	440575	168,-
500 cm	K: 200 cm			440576	222,-	440576	222,-
550 cm	K+I: 250 cm			440499	58,90	440499	58,90

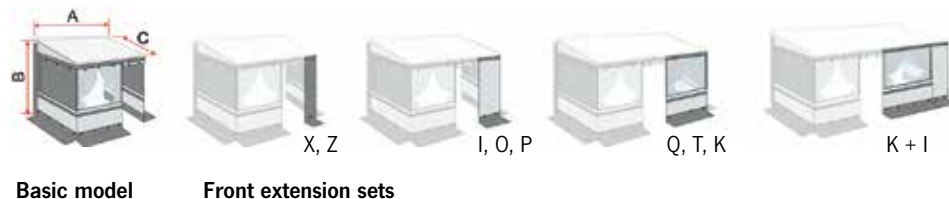

- Consisting of side panels and front
- Material: Polyester
- Mounting side panels with FastClip
- Front window roll up, with mosquito net
- Side windows with blackout and mosquito net
- Incl. Bag Megabag light (140x25x25 cm)
- Also suitable for vans
- Incl. Curtains for front windows
- Door usable left and right
- Zippers connect front and side walls
- Also suitable for Thule awnings with optional kit Privacy O (E4263)

Scope of delivery basic model:

Front part with window and curtains, 2 side panels, pegs.

Accessories:

Curtains, 1 pair, Dark Grey **440486 84,-**
 Curtains, 3 pairs, Dark Grey **440487 208,-**

Kit Privacy O E4263 49,90

for mounting on Thule awning

Wind screens: Page 185



New extension sets in 40, 150, 200 and 250 cm



Magic Kit Privacy

Teleopic reinforcement bars

Reinforce awning supports for awnings tents

Magic Kit Privacy Front Short

for Privacy 260 to 360 & 450 **44410 141,-**

for Privacy 400, 410 & 440 **44411 178,-**

for Privacy 500 & 550 **44412 201,-**

Magic Kit Privacy Side 44413 87,20



Press-rod



Pressure bars

Vertical pole to support the awning Privacy on the wall of the vehicle. To be ordered separately with Privacy Room Light and Privacy Room CS Light.

E3542 91,60

Special awning for VW T5/T6 Multivan & California w/ Volkswagen rails

- With matching adapter
- Double piping on the front profile
- Awning width 263/308 cm
- Cloth width 247/292 cm
- Extension: 200 cm
- Weight: 19.5/22.0 kg

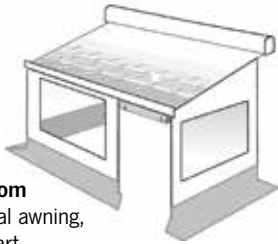

Accessories

Awning **Privacy Room** for VW T5 KR special awning, consists of: Front part, 2 side parts. Fast construction with Fast Clip System [Page 147](#)
Special sealing rubber [Page 157](#)



Fiamma F45S
Special awning for T5/T6/T6.1

Side wall awning incl. adapter for Volkswagen Multivan

For mounting on original VW rail on the roof.

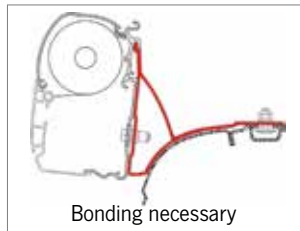

Awning (width 260 cm) for Volkswagen Multivan KR

Royal Grey, Case Titanium	4376730	959,-
UK version	4376740	959,-
Royal Grey, Case Deep Black	4376780	959,-
UK version	4376782	959,-

Bonding necessary



Awning (width 300 cm) for Volkswagen Multivan LR

Royal Grey, Case Titanium	E46270	991,-
UK version	4376742	991,-
Royal Grey, Case Deep Black	E10168	991,-
UK version	4376783	991,-

Side wall awning incl. adapter for Volkswagen California

For California with sleeping roof and side VW Keder rail.

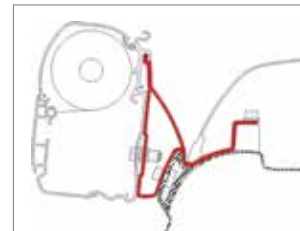

Awning (width 260 cm) for Volkswagen California

Royal Grey, Polar White case	4376709	947,-
Royal Grey, Titanium case	4376710	948,-
Royal Grey, Case Deep Black	4376760	948,-



Awning set F45S

for Citroën Spacetouer/Jumpy ≥ 2016,
Peugeot Traveller/Expert ≥ 2016,
Toyota Proace (Verso) ≥ 2016,
Fiat Scudo ≥ 2016,
Opel Zafira D/Vivaro ≥ 2019

- Awning F45S in width 260 cm
- Incl. vehicle-specific adapter

Scope of delivery: Awning, adapter & crank handle

PPE set F45s White

Housing color: Polar White,
Cloth color: Royal Grey
437680 **974,-**

PPE set F45s Black

Housing color: Deep Black,
Cloth color: Royal Grey
437681 **995,-**

Fiamma F45S
Special awning for PSA compact vans



Accessories for Fiamma F45S: Front and side panels [page 158-159](#)

Fiamma F43van
Special awning for buses



Wall awning F43van

- Crank with magnetic lock
- Low housing, especially for buses with and without pop-up roof
- Negative cloth inclination for flat vehicles
- LED device in the housing
- 2 piping rails

Cloth Royal gray, housing Deep Black. Mounting adapter required.

F43van	270	300
Awning width	270 cm	310 cm
Cloth width	257 cm	287 cm
Excerpt	225 cm	250 cm
Weight	19,0 kg	21,5 kg
Item no.	440545	440546
Price	883,-	964,-



Available from 2. Quarter 2024



VW T5/T6 kR
For Brandrup gutter.
2 black holders 12 cm each.
440525 108,-

Bonding necessary

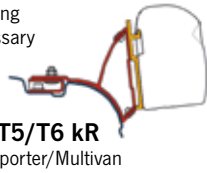

VW T5/T6 kR
Transporter/Multivan without C-profile.
2 black holders, 21.5 cm each.
Mounting on the vehicle
right 440707 138,-
left (UK) 440708 138,-



VW T5 / T6 / T6.1 kR
For REIMO Multirail rain gutter.
Even with pop-up roof
2 black holders, 8 cm each.
440534 139,-

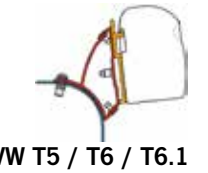

VW T5 / T6 / T6.1
Lift Roof. kR + IR.
2 black holders, 21.5 cm each.
Mounting on the vehicle
right 440709 117,-
left (UK) 440710 117,-



VW T5 / T6 / T6.1 California
2 black holders 12 cm each.
440714 139,-

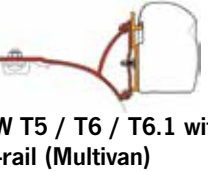

VW T5 / T6 / T6.1 with C-rail (Multivan)
2 black holders à 12 + 21,5 cm.
Mounting on the vehicle
right 440716 139,-
left (UK) 440717 139,-



VW T4
With Brandrup rain gutter or REIMO Multirail. kR + IR.
2 silver holders, 8 cm each
433201 123,-



VW T3
Bracket for the rain gutter.
Also with pop-up roof.
2 black holders, 8 cm each
43312 130,-



Ford Custom Lift Roof
kR + IR. Only open awning when sliding door is closed.
2 black holders 12 cm each.
Mounting on the vehicle
right 440602 179,-
left (UK) 440603 179,-



Traffic/Vivaro until 2015
For L1 /L2
2 silver holders, 16 cm each.
440713 108,-



PSA
2 black holders, 20 cm each.
440715 185,-



MB Marco Polo
Mercedes Marco Polo long from 2014. Only for manual pop-up roof. 2 silver holders à 12 + 13 cm
433413 272,-



Renault Trafic, Opel Vivaro, Fiat Talento as of 2015
kR + IR.
2 silver holders, 16 cm each.
440712 106,-



Ford Custom Nugget
Ford Custom Nugget with H2/L2. 2 silver holders, 12 cm each
434561 104,-



Car Adapter top
For mounting on the support tube of the roof rack.
2 silver holders, 8 cm each
43398 113,-

Matching awning blinds on right-hand side



Awning F43 VAN probably available from May 2024



Westfalia high roofs
For Westfalia high roofs w/ awning preparation.
2 silver holders, 12 cm each.
43483 53,50



Ford Custom Nugget
Ford Custom Nugget from '15, H1/L1 w/ pop-up roof.
2 black holders 8 cm each.
434563 278,-



For roof rack
Fits traverses w/ a maximum width of 55 mm.
For awning installation, min. 2 holders are required. 1 silver holder à 12 cm
43368 161,-

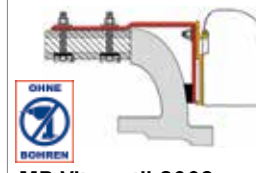

MB Vito until 2003
For Vito compact with original Mercedes roof rack. 2 silver holders 14 cm each
43317 177,-

Roof awning F40van

- Reinforced articulated arms
- Mounting with deep-seated adapters
- Space-saving, reduced protrusion

Cloth Royal grey, case Deep Black.
Mounting adapter required.

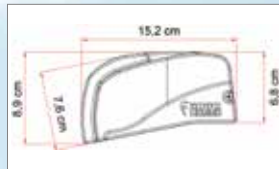

Fiamma F40 van Special awning for buses



	NEW 2024		
F40van	210	270	
Awning width	210 cm	270 cm	
Cloth width	199 cm	257 cm	
Excerpt	150 cm	225 cm	
Weight	17,0 kg	19,0 kg	
Item no.	440547	44364	
Price	955,-	1043,-	



Mounting adapter for F40van

For VW T5 / T6
Transporter and
Multivan without
C-rail in the roof

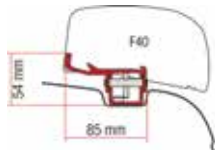

2 holders in black (1 x 20 cm + 1 x 25 cm)
short wheelbase

Incl. Kit upgrade	440530	130,-
short wheelbase UK version		
Incl. Kit upgrade	440531	130,-
short wheelbase UK version		
	443651	125,-

NEW 2024 For VW T5 / T6 Transporter and
Multivan with C-rail in the roof

2 black holders à 20 cm (not shown)
kR + IR (also UK) **440618 119,-**

For Ford Custom

2 black holders		
short wheelbase	44336	271,-
short wheelbase UK version	443000	271,-
long wheelbase (also UK)	44339	261,-



- Mounting on existing roof points
- Can be dismantled again at any time
- No drilling, no gluing

For NV 200 **NEW 2024**
Black holder
(2 x 25 cm + 1 x 10 cm)
440619 139,-

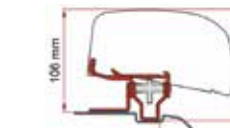

For PSA 260 Van
Citroën Spacetourer,
Peugeot Traveller, Toyota
Verso and the like. Black.
443371 440,-

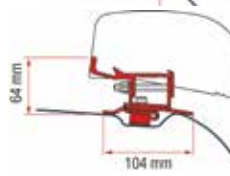

For Mercedes-Benz
V-Class from 2014
2 black holders
(1 x 39 cm + 1 x 22 cm)
44337 329,-



For Renault Trafic from 2014
2 black holders
short wheelbase (also UK)
44349 230,-
long wheelbase (also UK)
44338 314,-

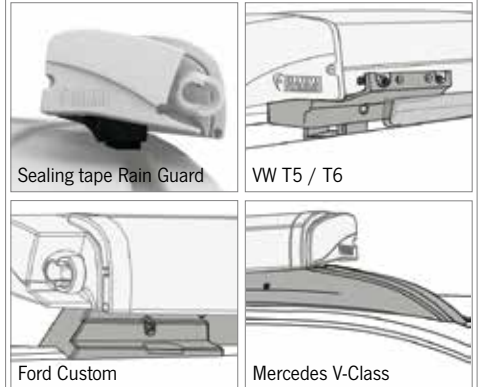
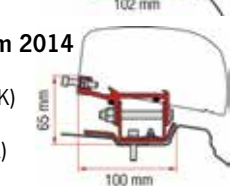

Rain Guard sealing tape for F40 van

Provides a seal between the awning and the
Vehicle roof. An ideal extra to the adapter.

VW T5 / T6	433884	169,-
Ford Custom kR	433006	175,-
Ford Custom kR (UK version)	433005	175,-
Ford Custom IR	433008	175,-
Ford Custom IR (UK version)	433007	175,-
Mercedes-Benz V-Class	433009	199,-

Room Van complete awning tents for F40 van + F43 van

- No additional linkage
- Ripstop material -
- lightweight and tear-resistant

- Incl. Pannier
- Mounting height 180-210 cm

NEW 2024

Now also in 300 cm width



Room Van. Side parts without
window, erectable front with window,
weight 4.8 kg
B 270 cm 443600 846,-



Room Van Premium. Side sections
w/ roll-up windows & mosquito net,
front with door, weight 5.4 or 5.8 kg.
B 270 cm 443601 986,-
B 300 cm 440579 1112,-

Room Van side panel & front panel F40 van + F43 van



Side W Pro side panel
Side part with window, weight 3.0 kg
B 270 cm 443602 272,-



Front wall blocker Pro
Front part with panoramic window
B 270 cm 4349151 248,-

Fiamma F35pro

For Buses, vans and small caravans



F35PRO for vans - Titanium housing

Wide	Excerpt	Weight	H _{max.} front	Royal Grey	Royal Blue	Price
180 cm	180 cm	8,5 kg	195 cm	43775	43770	547,-
220 cm	225 cm	10,5 kg	225 cm	43776	43771	602,-
250 cm	225 cm	11,5 kg	225 cm	43777	43772	624,-
270 cm	225 cm	13,0 kg	225 cm	43778	43773	627,-
300 cm	225 cm	14,0 kg	235 cm	43779	43774	653,-

- Housing in deep black or titanium
- Robust, anodized aluminum housing
- Practical roller blind pullout
- The double keder rail allows two front parts or accessories to be retracted at same time
- Lightweight, compact and quick to open and close
- Support feet lie in the awning tube
- Extensive range of accessories

F35PRO for Vans - Deep Black housing

Wide	Excerpt	Weight	H _{max.} front	Royal Grey	-	Price
180 cm	180 cm	8,5 kg	195 cm	43721	-	547,-
220 cm	225 cm	10,5 kg	225 cm	43729	-	602,-
250 cm	225 cm	11,5 kg	225 cm	43780	-	624,-
270 cm	225 cm	13,0 kg	225 cm	43781	-	627,-
300 cm	225 cm	14,0 kg	235 cm	43735	-	653,-

Scope of delivery: Awning in housing, pegs and lines for fastening to the ground.

Accessories for Fiamma F35

Vehicle adapter	right side
Front and side walls	Page 158-159
Awning PrivacyRoom CS Light	Page 154



Compact awning for Volkswagen Caddy, Citroën Berlingo and Co.

- Mounting on the roof rack
- Practical roller blind pullout
- Support feet lie in the awning tube

FIAMMA F35 Pro with a width of 180 cm is ideal for small vehicles. Weighing only 8.5 kg and extending 180 cm, it provides a shaded area of 2.9 m². The assembly can be mounted on almost all roof racks with the specified adapter. Case color: Titanium.

Scope of delivery: Awning, pegs and guy lines.

Awning width 180 cm

Cloth Royal Grey	43775	547,-
Cloth Royal Blue	43770	547,-

Awning width 220 cm

Cloth Royal Grey	43776	602,-
Cloth Royal Blue	43771	602,-

Accessories for Fiamma F35:

Front and side walls	Page 158-159
other mounting adapters	Page 153

Awning installation on Volkswagen Caddy & Co.

For mounting, there are universal adapters, e.g. for roof racks, or vehicle-specific adapters adapted to individual vehicles. You can find the adapters on the right side or ask your dealer.

Awning widths: For Volkswagen Caddy kR, Citroën Berlingo, Peugeot Partner and Ford Tourneo Connect up to YOC. in 2013, awning width 180 cm is recommended, for Volkswagen Caddy Maxi a width of 220 cm.

Adapter for F35PRO



VW T5 / T6
Screwing to existing points, no gluing.
Not for C-rail.
2 holders 12 cm each.
E6413 95,40



VW T5 / T6
For Multivan or Transporter w/ roof rail. Gluing necessary. 2 holders 12 cm each.
43340 105,-



VW T5 / T6
For Multivan/Transporter w/o roof rail.
Gluing necessary. 2 x 21,5 cm. right **433403 123,-**
left, (UK) **433404 123,-**

Multirail adapter
Special adapter for the REIMO Multirail, also for folding sleeping roofs.
Black brackets for mounting the F35 Pro to the Multirail. Awning and adapter are removable without affecting the appearance of the vehicle.
ATTENTION: only mountable w/ existing Multirail.

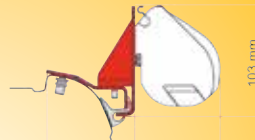

VW T5 / T6 / T6.1
with REIMO Multirail rain gutter. Suitable for left & right hand drive. Removable.
2 black holders 8 cm each.
440533 141,-

TIP



VW T5 / T6 / T6.1
Mounting on the REIMO Multirail. Suitable for KR + LR. Removable.
426768 197,-

Citroen Spacetourer
and similar to REIMO Multirail. For L2 / L3. Removable.
426769 197,-



Westfalia Kepler VW T6 LR
for L2, 2 holders of 10 cm each.
433406 136,-



VW T5 / T6 VW California.
2 holders à 12 cm
433401 111,-



Also for folding sleeping roofs

VW T5 / T6 VW Bus
with Branderup gutter. Suitable for left & right hand drive. 2 black holders 8 cm each.
440532 124,-



VW T3
Adapter set for rain gutter mounting. 2 holders à 8 cm.
43441 105,-

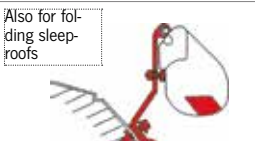

Also for folding sleeping roofs

VW T4
Adapter kit for flat roof mounting. 2 holders à 8 cm
43330 75,30



VW T4
For Branderup gutters
2 holders à 8 cm.
433201 123,-

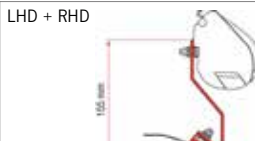

LHD + RHD

VW Caddy Maxi with folding sleeping roof
Black, from YOC. 2016.
2 holders 12 cm each.
433418 150,-

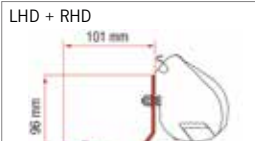

LHD + RHD

VW Caddy Maxi
Black, from YOC. 2016, for awning width 220 cm.
2 holders à 8 cm.
433417 111,-



NEW 2024

ford Transit Custom
2 holders à 12 cm
right **440602 179,-**
left, (UK) **440603 179,-**



Dreamer
Cap Land/Cap Fun
Ford Transit Custom
2 holders 12 cm each.
433416 137,-

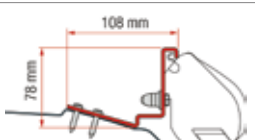

Dreamer
Cap Coast (L1)
Cap Land/Cap Life (L2)
Ford Transit Custom
2 holders à 12 cm
44335 143,-



Citroën Spacetourer, Peugeot Traveller, Toyota Verso, Opel Zafira from 2019
2 holders à 20 cm
44329 159,-

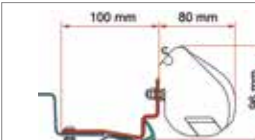

Ca
on Peugeot Expert
2 black holders 12 cm each. Suitable for left & right hand drive.
440529 74,20



Mercedes-Benz Vito until YOC. 2004.
2 holders à 8 cm.
43341 119,-

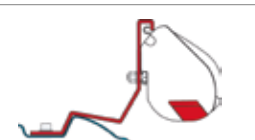

Mercedes-Benz Vito/Viano and V-Class
from 2014, 2 holders à 13 cm. Not with REIMO-SD.
433412 115,-

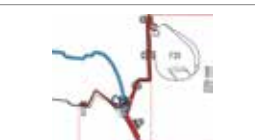

Mercedes-Benz V-Class Marco Polo from 2014
1 holder à 12 cm and 1 holder à 13 cm.
433413 272,-



Westfalia Jules Verne Mercedes Vito
2 holders 12 cm each.
433414 132,-



Nissan NV200/Evalia
For awning width 220 cm.
2 holders à 8 cm.
433415 123,-



Kit car for roof rack
2 holders à 8 cm.
43398 113,-



Standard
2 holders à 8 cm.
43348 92,70



Eriba Touring
Adapter kit for Eriba Touring.
2 holders à 13 cm.
43366 108,-



Renault Traffic Until YOC. 2015
2 holders à 12 cm
433131 97,10



Opel Vivaro From YOC. 2015
2 holders à 12 cm
433132 103,-

Fiamma Privacy Room CS Light Awning blind for F35 pro



Window roll up, incl. mosquito net



Fast clip

Awning Tent Retrofit Kit for F35 Pro

Type	250 VAN	270 VAN	280	310
for awning	F35 (250 cm)	F35 (270 cm)	F35 (270 cm)	F35 (300 cm)
Mounting height	180-220 cm	180-220 cm	240-260 cm	240-260 cm
Weight	8,7 kg	9,1 kg	11,6 kg	11,8 kg
Accessories needed			Adapter 434743 (for mounting on F35 270)	Adapter 434743 (for mounting on F35 300)
itemNo.	440490	440491	440488	440489
Price	1031,-	1036,-	1077,-	1101,-

Adapter for PrivacyRoom CS Light to F35 Pro 434743 19,70

More living space for the F35 PRO with awning retrofit kit

- With Fast Clip fastening system: aluminum profile consisting of two parts into which the side panels can be pulled in more quickly.
- Connection to the vehicle wall by elastic tensioning straps
- Front retractable into the awning keder rail
- Connection front/side parts by zippers
- Door retractable left or right
- Windows of the front with curtains
- Windows of side parts w/ mosquito nets
- Incl. Pannier Mega Bag light

Fiamma SlideOut

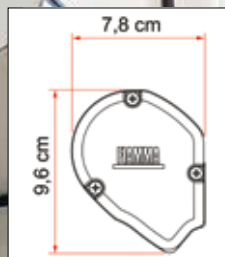

SlideOut systems can be found in motorhome technology section

Special SlideOut awning system for vehicles with extendable walls

The awning for mobile vehicle walls

Ideal solution for vehicles w/ retractable side & rear walls. They protect the extension with an awning cloth that can be rolled out up to one meter and also automatically rewinds.

Special awning Slide Out

Type	200	280
Awning width A	198 cm	278 cm
Cloth width B	192 cm	272 cm
Extract C	100 cm	100 cm
Weight	7,3 kg	10,0 kg

Housing Polar White

Royal Grey	42527	42528
Price	504,-	583,-

Fiamma ZIP
Fiamma F45 with optional Awning



ZIP S



ZIP L



Detail

- Assemble awning based on F45 and complete awning
- Side sections are connected to the awning fabric with zippers
- All Crystal windows can be opened.
- Increased tightness against wind
- The door in the front can be mounted on the left or right side
- The fastening system (Rapid Set) stabilizes the awning
- Tight connection to vehicle through padded bar

Scope of delivery: Awning based on F45 incl. mounting brackets/adapters, front & side panels, ZIP zipper system, Crystal window roll-up, standard w/ mosquito net & curtains, Rapid Set mounting system & Rafter tensioning pole, Skirting windshields, tensioning straps, hooks & Mega Bag for privacy & poles

Accessories for Fiamma ZIP:

Additional tie rods	see page 160
Curtains, 1 pair	440486 84,-
Curtains, 3 pair	440487 208,-



How to order the Fiamma ZIP with matching awning

Choose the length of the awning below according to your needs. Attention: These are special awnings. The normal F45 does not fit.

Order the matching awning basic model in the desired attachment height and complete the full width with the specified front panel extensions.

1. Select awning							+ 2. Order awning basic model in addition			+ 3. Front extension		
Awning model	(A) Total width	(C) Extract	Weight	Color Royal Grey	Color Royal Blue	Price	Awning basic model available in 2 heights	Item no.	Price	Order extension front panels	Item no.	Price
Fiamma ZIP Housing White												
ZIP 300 (F45S)	306 cm	250 cm	23,5 kg	434051	434052	1162,-	Privacy Room M B: 225 - 250 cm or Privacy Room L B: 225 - 250 cm	434037	1700,-	—		
ZIP 350 (F45S)	356 cm		23,5 kg	434053	434054	1228,-				① 50 cm	435311	68,70
ZIP 400 (F45L)	406 cm		36,5 kg	434055	434056	1650,-				② 100 cm	436623	138,-
ZIP 450 (F45L)	456 cm		36,5 kg	434057	434058	1910,-				③ 150 cm	436625	196,-

Fiamma Caravanstore Caravan awning for the keder rail



The caravan awning in the case

- Lightweight and compact, arms and support feet lie in the awning tube
- Pullout possible to half length
- Waterproof case
- Mounting in the existing keder rail
- Awning cloth lightweight and waterproof, can be rolled up in both directions
- No wrinkling, even if awning is closed for a longer time
- For caravans, folding caravans & small motorhomes

Accessories:
side parts
Privacy Room CS Light

Blocker Front/
Page 158-159
see below

Kit hobby
For mounting the
Caravan gate
to hobby living-
trolley 2009.
E3325 18,60



Fiamma Caravanstore/Caravanstore XL - the light caravan awning for keder rail

	Light gray case										Case black
Type	190	225	255	280 XL	310 XL	360 XL	410 XL ¹⁾	440 XL ²⁾	500 XL ³⁾	550 XL ³⁾	310 XL
Total width	193 cm	235 cm	264 cm	286 cm	316 cm	36 cm	415 cm	448 cm	497 cm	547 cm	316 cm
Cloth width	162 cm	202 cm	232 cm	254 cm	284 cm	334 cm	384 cm	414 cm	465 cm	515 cm	284 cm
Excerpt	180 cm	225 cm	225 cm	250 cm	250 cm	250 cm	250 cm	250 cm	250 cm	250 cm	250 cm
Weight	6,0 kg	7,5 kg	8,5 kg	10,1 kg	11,2 kg	12,3 kg	13,5 kg	14,6 kg	15,8 kg	16,9 kg	11,2 kg
Royal Grey	44362	443621	443622	44423	444231	444232	444233	444234	444235	444236	44425
Royal Blue	44363	443631	443632	44424	444241	444242	444243	444244	444245	444246	—
Price	468,-	515,-	544,-	553,-	553,-	585,-	647,-	722,-	793,-	847,-	592,-

¹⁾ For 410 cm incl.: 1 tie rod Rafter ²⁾ For 440 cm incl.: 1 Rafter + additional. Front support ³⁾ At 500 cm + 550 cm incl.: 2 add. Front supports

Fiamma Privacy Room CS Light Retrofit awning for caravan door

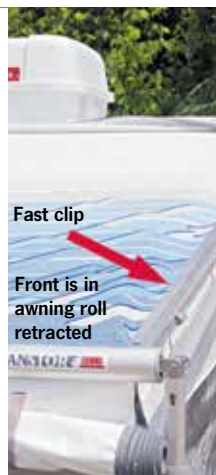

More living space for caravan gate and Caravan Gate XL

- For Caravanstore from model 2004 w/ awning extension of 225 cm & Caravanstore XL w/ 250 cm extension
- With Fast Clip attachment system:
- Connection to caravan wall by elastic tension straps
- Front retractable into the keder rail
- Connection front/side parts by zippers
- Door retractable left or right
- Windows of the front with curtains
- Windows of the side parts with mosquito nets
- Incl. Pannier Mega Bag light

Awning Tent Retrofit Set for Caravan Gate / Caravan Gate XL

Basic model	CS Light 280		CS Light 310		CS Light XL 280		CS Light XL 310	
	440488	1077,-	440489	1101,-	440492	1146,-	440493	1159,-

Awning length	Front panels	+ Front extension sets to adjust the width						
360 cm	N: 50 cm		440499	58,90			440499	58,90
410 cm	Q: 100 cm		440501	117,-			440501	117,-
440 cm	S: 130 cm		440503	150,-			440503	150,-
500 cm	V: 190 cm						440504	184,-
550 cm	K + K + V 20(2x)+190cm						2 x 440497 + 440504	54,50 184,-

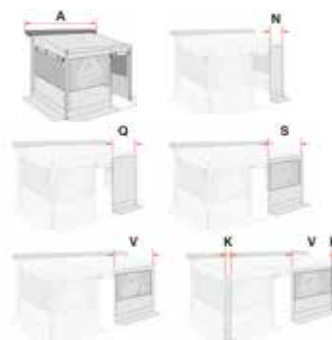

Fiamma Caravanstore ZIP XL Caravan awning with optional blind



Caravan awning in case

- Awning in case, blind can be ordered as accessory
- Robust YKK zippers
- Rapid" linkage - facilitated assembly

Scope of delivery awning:

Caravan gate awning, aluminum poles "Rapid Set" and Mega Bag. From type 360 w/ additional front support, from type 500 w/ 2 additional front supports.

Optional Privacy Caravanstore Zip awning

- Roll up front part and side parts
- Robust YKK zippers
- Incl. Transport bag "Mega Bag"

Scope of delivery awning:

Front w/ door & 2 side walls, each incl. window w/ mosquito net & curtains, aluminum frame "Rapid Set", tension straps, hooks & Mega Bag.

Accessories:

Curtains, 1 pair, Dark Grey	440486	84,-
Curtains, 3 pairs, Dark Grey	440487	208,-

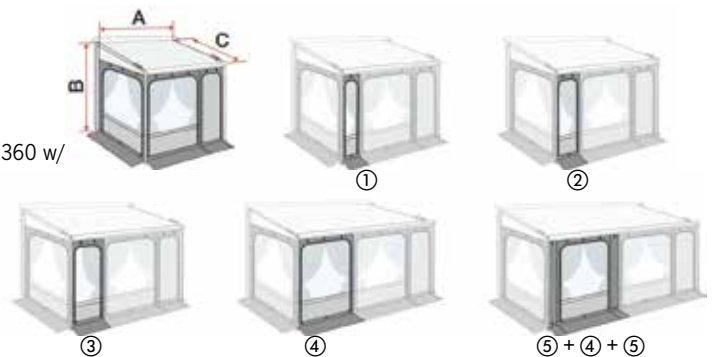

How to order the CaravanStore ZIP XL with matching awning

Choose the length of the awning according to your needs. If desired, order the matching awning base model and complete the full width with the specified front panel extensions.

1. Select awning							+ 2. Order awning basic model in addition			+ 3. Front extension		
Awning model CaravanStore	(A) Total width	(B) Mounting height/ (C) Extension	Weight	Color Royal Grey	Color Royal Blue	Price	Matching awning basic model Privacy Cstore ZIP	Item no.	Price	Order extension front panels	Item no.	Price
ZIP XL 280	288 cm	240-260 / 250 cm	31,1 kg	443751	443752	709,-	XL 280	443766	1584,-			
ZIP XL 310	318 cm		32,5 kg	443753	443754	737,-	XL 310	443767	1666,-			
ZIP XL 360	369 cm		34,3 kg	443755	443756	862,-	XL 310	443767	1666,-	① 50 cm	435311	68,70
ZIP XL 410	419 cm		35,7 kg	443757	443758	889,-				② 100 cm	436623	138,-
ZIP XL 440	449 cm		37,2 kg	443759	443761	917,-				③ 130 cm	436634	169,-
ZIP XL 500	509 cm		38,9 kg	443762	443763	1112,-				④ 190 cm	436635	233,-
ZIP XL 550	559 cm		40,7 kg	443764	443765	1168,-				⑤ 2x 20 cm + ④ 190 cm	436620	62,20

Blocker Pro



With blockers you quickly & inexpensively create a protection against wind & sun, no fixed connection at the edges of the front and side panels.

from **144,-**

Rainproof Front section w/ panoramic window

Front wall with large window and gray floor extension. Made of water-repellent, UV-resistant vinyl. Feeding into the keder rail. With pegs.



Designation	F45	F80S	F80L	F65	C-St	F35	Width A	Width B	Height C	Art. No.	Price
Blocker Pro 100	●	●		●	●	●	± 100	100	225-280	44381	144,-
Blocker Pro 250	●				●	●	± 235	250-260	225-280	434915	222,-
Blocker Pro 260 VAN*	●				●	●	± 250	260-270	180-220	4349151	248,-
Blocker Pro 300	●	●		●	●	●	± 285	300-320	225-280	4349152	251,-
Blocker Pro 325			●				± 310	325		4349161	264,-
Blocker Pro 350	●	●		●	●		± 335	340-370	225-280	4349153	263,-
Blocker Pro 375	●						± 360	375	225-280	4349154	281,-
Blocker Pro 400	●	●		●	●		± 385	400-410	225-280	4349155	285,-
Blocker Pro 425	●	●		●			± 410	425	225-280	4349156	309,-
Blocker Pro 440					●		± 415	440	225-280	4349157	309,-
Blocker Pro 450	●	●		●			± 435	450	225-280	4349158	309,-
Blocker Pro 500	●				●		± 463	500	225-280	4349159	346,-
Blocker Pro 550	●				●		± 513	550	225-280	4349160	374,-

* also suitable for F40 VAN and original VW California awning.

Side W Pro



from **268,-**

Rainproof side panel with window

Practical side wall with large window and bottom extension. Made of water-repellent, UV-resistant vinyl. Incl. telescopic rafter pole and pegs.



Designation	F45	F80S	F80L	F65	C-St	F35	Depth A	Height B	Art. No.	Price
Side W Pro F80L XL				●			275	245-280	434969	334,-
Side W Pro F80L XXL				●			275	281-310	434970	363,-
Side W Pro F45/F65/F80	●	●			●		230	225-280	434972	287,-
Side W Pro XXL F45/F65/F80	●	●			●		230	280-330	434973	337,-
Side W Pro F45S f. VW T5/T6 *	●						190	180-200	434974	287,-
Side W Pro F65/F80 Fiat Duc.		●			●		230	225-280	434975	287,-
Side W Pro Caravanstore						●	210	240-260	434976	268,-
Side W Pro Caravanstore XL						●	240	240-260	434977	316,-
Side W Pro F35 Van						●	210	180-220	434978	278,-

* also suitable for VW California from YOC. 2003.

Side W Pro Shade



SHADE with window blackout

Rainproof Side panel with window & blackout

Side wall with large window and roll-up blackout. Otherwise like Side W PRO. Incl. telescopic aluminum tension rod and pegs.



Designation	F45	F80	F65	C-St	F35	Depth A	Height B	Item no.	Price
Side W Pro Shade right	●	●	●			230	225-280	434979	397,-
Side W Pro Shade left	●	●	●			230	225-280	434980	397,-

Side W CaravanStore



Further front and side panels for caravan doors on page 129

Rainproof Side panel with window

Side wall with window made of water-repellent, UV-resistant vinyl. Incl. telescopic aluminum rafter rod and rubber tensioners.



Designation	F45	F80	F65	C-St	F35	Depth A	Height B	Item no.	Price
Side W Caravanstore				●	●	210	240-260	434981	220,-
Side W Caravanstore XL				●		250	240-260	434982	283,-

● Possible for the marked awning types. No adapter necessary.

● Mounting only possible with adapter!!!

The mounting of these side parts is only possible with the corresponding adapter.

Adapter kit for mounting on F65(S) / F65(L)	434991	13,10
Adapter kit for mounting on F80S	434990	43,60
Adapter kit Omnistor 5002/5003	434995	20,80

Shade-providing Front part made of mesh fabric

Mesh front wall. Reflects 85% of the light. Feeding into the keder rail. Can be rolled up with fastening clips. Incl. Pegs and tension straps. The mesh fabric is translucent and breathable.

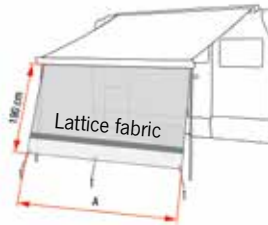

Designation	F45	F80s	F80L	F65	C-St	F35	Width A	Width B	Item no.	Price
Sun View XL 100	●	●		●	●	●	± 100		44384	125,-
Sun View XL 260	●				●	●	± 250	250 - 260	44385	157,-
Sun View XL 300	●	●		●	●	●	± 285	300 - 320	44386	166,-
Sun View XL 325			●				± 310	325	434905	183,-
Sun View XL 350	●	●		●	●		± 335	340 - 370	44387	183,-
Sun View XL 375	●			●			± 360	370	44388	204,-
Sun View XL 400	●	●		●	●		± 385	400 - 410	44389	204,-
Sun View XL 425	●	●		●			± 410	425	44390	222,-
Sun View XL 450	●	●		●			± 435	450	44391	222,-
Sun View XL 500	●			●			± 463	500-510	44392	247,-
Sun View XL 550	●			●			± 513	550	44393	262,-

Even more Sun protection on page 130



Sun View XL

Shade-providing Side panel made of mesh fabric

Side wall made of breathable translucent mesh. Reflects 85% of the light. Provides a pleasant indoor climate. Incl. Rafter tension rod, tension straps and pegs.



Designation	F45	F80s	F80L	F65	C-St	F35	Depth A	Height B	Item no.	Price
Sun View Side F80L			●				275	245 - 310	434906	296,-
Sun View Side F45/F70/F65	●	●		●			230	220 - 260	44394	272,-
Sun View Side Caravanstore					●	●	210	240 - 260	44395	254,-

Sun View Side



Rainproof vinyl blocker

Practical blockers that protect against rain and sun. Includes pegs and tension straps.

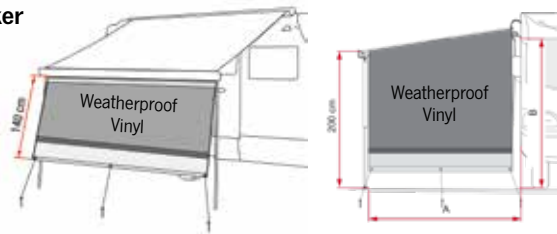

Blocker front - Feed into front spring rail

Designation	F40	F45	F80s	F80L	F65	C-St	F35	Width A	Width B	Art. No.	Price
Blocker 260	●	●				●	●	± 253	260-300	44382	142,-
Blocker 300		●	●			●	●	± 285	300-320	434901	152,-
Blocker 325				●				± 310	325	434904	168,-
Blocker 350		●	●		●	●		± 335	340-370	434902	168,-
Blocker 400		●	●		●	●		± 385	400-410	434903	172,-
Blocker 450		●	●		●			± 438	>450	44383	196,-

Side block - incl. aluminum tension rod

Designation	F45	F80s	F65	C-St	F35	Depth A	Height B	Item no.	Price
Side block F45/F80	●	●				230	220 - 260	440568	269,-
Side Block Caravanstore XL				●		240	180 - 260	440569	264,-

Blocker and side block



Glare shield for F45, F65, F80 Caravanstore and F35

Shade valance - practical sun visor

Practical valance for pulling into piping rail. Series at Caravanstore. Suitable for any awning with keder rail. Can be shortened to awning width.

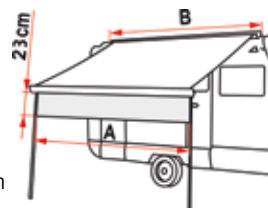

Designation	F40	F45	F80	F65	C-St	F35	Width A	Width B	Art. No.	Price
Valance from Mesh	●	●	●	●	●	●	550	190-550	437471	39,30

Shade valance



TIE RODS AND ACCESSORIES

Awning tensioning poles - Rafter / Rafter PRO

- Increases the rigidity of the awning, better fabric tensioning
- For awnings up to 250 cm extension (adjustable from 142-265 cm)
- Suitable for all housing awnings

Rafter straight



Rafter PRO curved



Rafter - straight tie rod
434554 59,50



Rafter PRO - curved tension rod

Also improves water drainage.
Attention: do not use in intense sunlight.

43315 84,-

Adapter F65

For older awnings F65 adapter is necessary to mount the rafter.

E4360 10,20



Magic Rafter PRO - crossbar with elevation

- Optimal transverse tensioning for awnings up to 450cm wide
- Better water drainage due to elevation of cloth
- A stiffener reduces wind noise
- Attention: Do not use in intense sunlight

43360 154,-



Rafter aluminum tie rods with twist locks

Tension rod for caravan door
w/ extension 225-250 cm

434553 45,70



Magic Rafter - Cross tension rod

- Universal rafter is clamped between the awning arms
- Better fabric tension, increased wind stability

43381 93,70

Further tension rods / rafters with lighting can be found on page 188

Adapter set for Thule awnings



Kit Privacy O - Optional Kit

Optional kit that enables the installation of the Fiamma products Privacy Room and Privacy Room Light on the awnings Thule 4900-5002-5003-5200, Tristor 2. Weight 0,2 kg

E4263 49,90



PLATE retaining plates

For fixing support leg to ground, safer in windy conditions. Plastic. With pegs for Fiamma and Omnistor. 20 x 20 cm.

2 piece 43547 19,10



Awnings repair kit

- Quick repair for tears in the awning cloth
- Self-adhesive
- Easy handling

43540 28,10



Awning spoiler

Improves air resistance and appearance. Protection from damage. Material ABS. Is glued on with Sikaflex. For awning F45 and others.

43493 34,90

Fig. shows aluminum



Wall mount

Support feet are securely hooked in. For mounting on the vehicle wall.

Aluminum 43549 44,50
Plastic white E1887 33,30



Privacy Rail Kit

Keder rail kit, with 4 rails of 100 cm each, which allows the attachment of an additional front part, should the awning not have a double keder rail in the front panel. Also suitable for attaching to the side panels

43596 38,90

RainGuard awning waterproofing

- Waterproofing against water penetration
- Between awning and vehicle wall
- Prevents the flow of rainwater

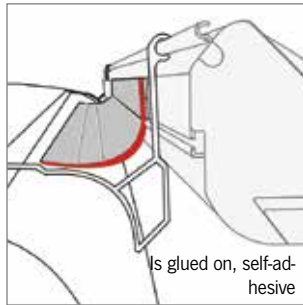

RainGuard Van

For awnings F45S and F35 Pro, which are mounted at a small distance from minivans.
Width 11 cm, color black
300 cm **433881 118,-**



RainGuard California

For awnings on VW T5/T6 California. Mounting by plugging into original VW rail.
Length 200 cm.
433880 50,20

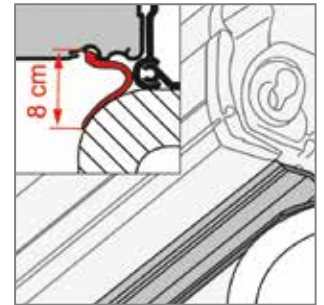

RainGuard Lower

For F45S awnings with distance between cassette and vehicle with raised installation.
running metre **43388 14,20**
550 cm **433882 89,40**



RainGuard S

For awnings mounted on a flat wall with a standard bracket. Clamps behind the awning.
550 cm **433841 62,20**

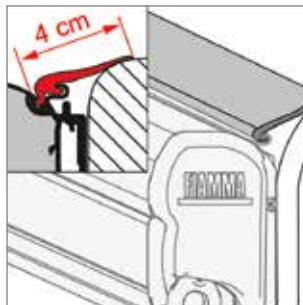

RainGuard M

For awnings mounted with adapters protruding up to 4 cm or on curved walls.
550 cm **433831 67,60**

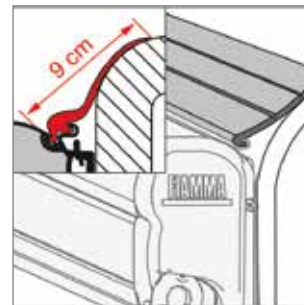

RainGuard L

For awnings mounted with adapters protruding up to 9 cm or on strongly curved walls.
550 cm **434852 76,30**

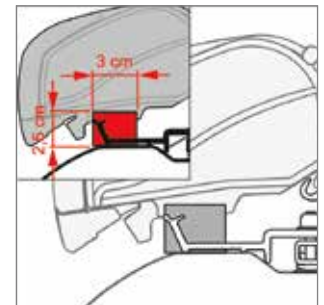

RainGuard Kit F65/F80

For F 65 or F 80S, cover the gap between roof and adapter. 450 cm. Self-adhesive
434851 51,10



Rain end caps

drain rainwater in a targeted manner. Ideal for use with awnings.
2 rubber covers to be placed on the front panel. For F45 and Fiamma ZIP.
Rain Caps F45S **43408 24,80**
Rain Caps F45L **43409 25,10**

Kit Cover + RainGuard Slim = sealing profile set for F80s

For awning F80s with flat mounting adapter on Fiat Ducato panel van. Self-adhesive sealing profile kit Rain Guard Slim and side covers Kit Cover.



① Kit Rain Guard Slim **440515 48,-**
② Kit cover **440513 40,40**



Transport bags

- Large and durable bag
- Ideal for transporting poles & tents

③ **Mega Bag Elite**

Dims.: L150 x H35 x D35 cm
443971 184,-

⑤ **Mega Bag**

Dims.: L140 x H40 x D27 cm
440593 60,-

④ **Mega Bag Smart L**

Dims.: L195 x H25 x D25 cm
443973 94,90

⑥ **Mega Bag Light**

Dims.: L140 x H25 x D25 cm
440594 46,90



Set of 6 hooks

for inserting into piping rail of front profile. Suitable for Fiamma & Thule Omnistor awnings. With 7 mm hole.
43443 9,85



Spare parts for Fiamma awnings

End caps housing

for F45i, F1		
white, right	43826	26,20
white, left	438261	25,20
for F45 Plus, F50		
white, right	43827	26,10
for F45iL, F1L		
white, right	43828	25,10
white, left	438281	25,10
silver, left	438283	50,20
for F45 Plus L		
white, right	43829	30,30
white, left	438291	30,30
for F45s		
white, right	E4434	59,10
white, left	E3914	59,10
silver, right	E6063	59,10
silver, left	E4968	59,10
black, right	E11465	59,10
black, left	E6667	59,10
for F65, Eagle		
white, right	43830	25,10
white, left	438301	25,10
silver, right	438302	28,50
silver, left	438303	28,50
for F65s version 15		
white, right	E4869	59,10
white, left	438304	59,10
silver, right	E3152	59,10
silver, left	E4374	59,10
black, right	E5272	59,10
black, left	E6471	59,10
for F80s		
white, right	E9589	59,10
white, left	E9571	59,10
silver, right	E11892	58,90
silver, left	E11056	58,90
black, right	E10646	58,90
black, left	E10647	58,90



End caps
(symbol representation)



End caps
(symbol representation)

End caps front profile

for F45i, F1		
white, right	43831	13,20
white, left	438311	13,20
for F45iL, F1L		
white, right	43832	13,20
white, left	438321	13,20
silver, right	438322	15,20
silver, left	438323	20,50
for F45s		
white, right	E4435	18,90
white, left	E3938	18,90
silver, right	E6377	18,90
silver, left	E4933	18,90
black, right	E10592	18,80
black, left	E7192	18,90
for F65, Eagle		
white, right	43833	17,80
white, left	438331	17,80
silver, right	438332	26,-
silver, left	438333	26,-
for F65s version 15		
white, left	E3807	16,80
silver, right	E4280	21,80
silver, left	E5983	21,80
black, right	E3197	21,70
black, left	SA1137	21,80
for F80s		
white, right	E5497	17,70
white, left	E9682	17,70
silver, right	E10422	17,70
silver, left	E11057	17,70
black, right	E72	17,70
black, left	E11588	17,70



End caps
Front profile
(symbol representation)



End caps front profile
(symbol representation)

Awning foot joints top

for F45i, F1		
right	43822	20,30
left	438221	20,30
for F45iL, F45TiL, F1L, F65		
right	43823	21,80
left	438231	21,80



Joint



Knurl



Foot lock

Awning foot lock

for awning foot with knurled screw		
1 pc.	43824	8,70
for caravan door, F35		
2 pcs.	438242	31,60

Locking piece for keder rail

for caravan door		
2 pcs.	43825	15,20



Locking piece

Clips for Privacy Room

10 pcs.	43834	39,90
---------	-------	-------

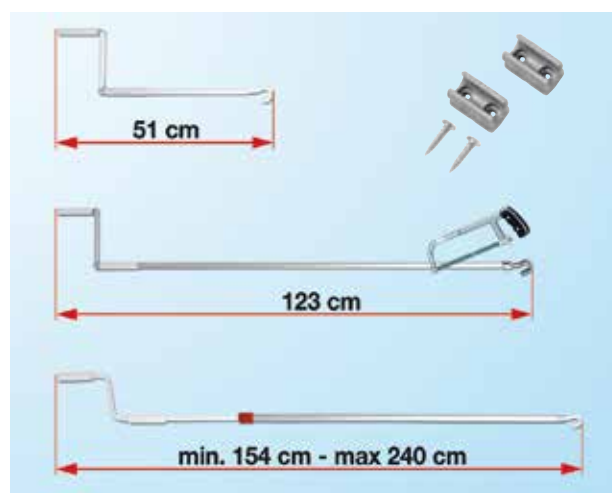

Hand cranks, handle foldable

51 cm	43356	48,-
123 cm	43357	57,80

Hand crank telescopic

154 - 240 cm	43358	70,90
2 mounting clips	43486	13,-

All images in symbolic representation. Further spare parts can be found at www.reimo.com under the respective article.



With camping accessories from Thule you are flexible on the road and have plenty of space, comfort and safety. With renowned products of the Belgian company Omnistor, Thule has for years offered awnings and accessories for many vehicle sizes. Thule itself was founded in Sweden in 1942 and offers for its motorhome and Caravan accessories have a warranty of 2 years. In addition to wall, roof and keder rail awnings, Thule sells many other useful products for camping and caravanning.

Different types of awnings



Roof awning TO 6300

Widths: 260 - 500 cm
 Excerpt: up to 250 cm
 Cloth colors: Mystic Grey, Sapphire Blue
 Housing colors: White, silver anodized, anthracite



Roof awning TO 9200

Widths: 400 - 600 cm
 Excerpt: up to 300 cm
 Cloth colors: Mystic Grey, Sapphire Blue
 Housing colors: White, silver anodized, cream



Wall awning TO 5200

Widths: 190 - 500 cm
 Excerpt: up to 250 cm
 Cloth colors: Mystic Grey, Sapphire Blue
 Housing colors: White, silver anodized, anthracite



Wall awning TO 8000

Widths: 400 - 600 cm
 Excerpt: up to 275 cm
 Cloth colors: Mystic Grey, Sapphire Blue
 Housing colors: White, silver anodized, cream, anthracite



Wall awning TO 4200

Widths: 260 - 300 cm
 Excerpt: up to 250 cm
 Cloth colors: Mystic gray
 Housing colors: White, silver anodized, anthracite



Special awning TO 3200

Widths: 190 - 300 cm
 Excerpt: up to 250 cm
 Cloth colors: Uni gray
 Housing colors: Silver anodized, anthracite



Special awning TO 5102

Widths: 260 cm
 Excerpt: up to 200 cm
 Cloth colors: Mystic gray
 Housing colors: Light gray, anthracite



Case awning TO 1200

Widths: 230 - 550 cm
 Excerpt: up to 250 cm
 Cloth colors: Mystic Grey, Sapphire Blue
 Housing colors: White

Housing colors



WHITE



SILVER ANODIZED



CREME



ANTHRACITE

Cloth colors



MYSTIC GRAY



SAPHIR BLUE

ROOF AWNING SET AND AWNING BLINDS FOR FIAT DUCATO

Thule Omnistor 6300 Awning set for Fiat Ducato



- For Fiat Ducato from YOC. 2007 w/ vehicle height H2 (app. 252 cm)
- Incl. Adapter set and sealing foam tape between awning and vehicle and adapter cover caps
- For vehicles with length 541 cm = awning 325 cm length 599 cm = awning 375 cm length 636 cm = awning 400 cm

Awning set with 6300 incl. adapter

Wide	325 cm	375 cm	400 cm
Excerpt	250 cm	250 cm	250 cm
Weight	24,0 kg	27,5 kg	29,0 kg

Housing White - Caps White

Mystic gray	428000	428001	428002
Price	1444,-	1498,-	1542,-

Silver housing - black caps

Mystic gray	428065	428066	428067
Price	1471,-	1525,-	1569,-

Silver housing - gray caps

Mystic gray	428072	428073	428074
Price	1471,-	1525,-	1569,-

Black housing - Black caps

Mystic gray	428075	428076	428077
Price	1471,-	1525,-	1569,-

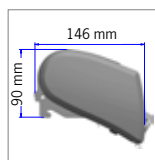

Panorama awning for FIAT Ducato Panel van



Photo shows awning tent w/ optional mosquito net.



- Side parts adapted to vehicle contour
- All pages completely removable with zipper
- OPTION: Removable mosquito screens
- Incl. Bottom apron and 2 panniers

Scope of delivery: Tent, pack bag, pegs and windbreak to prevent drafts from moving under the vehicle.

Further information & accessories: s. pg. 180.



Thule Panorama - awning tent for Ducato H2

Tent width	Mounting height	Item no.	Price
325 cm	Ducato (230 - 250 cm)	431791	2954,-
375 cm	Ducato (230 - 250 cm)	431792	3042,-
400 cm	Ducato (230 - 250 cm)	431793	3042,-

Awning QuickFit for FIAT Ducato panel van



- Side parts adapted to vehicle contour
- Small pack size
- Including floor skirt and curtains
- Front window can be opened completely
- 18 kg light
- Suitable for all Fiat Ducato awning widths (325 cm - 350 cm - 375 cm - 400 cm)
- Also suitable for Ducato models before 2007

Scope of delivery:

Tent, pannier (dims. app. 70 x 35 x 35 cm), pegs, curtains and wind screen to prevent draughts from passing under the vehicle.

Further information & accessories: s. pg. 178.

Thule QuickFit - awning tent for Ducato H2

Tent width	Mounting height	Item no.	Price
300 cm	Ducato (230 - 250 cm)	432145	1002,-



Roof mounting set
3 rails à 130 cm

432143 53,50



Incl. Pannier

Thule Omnistor 6300 Awning for vans and caravans



**Maximum
Extension 250 cm**

Shade and weather protection for vans, motorhomes & caravans

- Widths up to 500 cm, adjustable dropout angle
- From 375 cm with additional tensioning arms for perfectly tensioned awning cloth
- 3. Support foot optionally available from 375 cm width to increase stability
- Integrated rain gutter in the front strip



TÜV Rheinland,
one of most qualified providers of product testing & certification, has also certified many Thule products.



Additional clamping arms
Robust articulated arms with integrated, patented Tensioning arms ensure a perfectly tensioned awning fabric.

Thule Omnistor 6300 - Housing color white									
Wide	260 cm	300 cm	325 cm	350 cm	375 cm	400 cm	425 cm	450 cm	500 cm
Excerpt	200 cm	250 cm	250 cm	250 cm	250 cm	250 cm	250 cm	250 cm	250 cm
Weight	20,6 kg	24,1 kg	25,1 kg	26,8 kg	28,5 kg	30,5 kg	31,8 kg	33 kg	35,6 kg
Mystic gray	42830	428301	428302	428303	428304	428305	428306	428307	428308
Sapphire blue	42831	428311	428312	428313	428314	428315	428316	428317	428318
Price	1013,-	1100,-	1253,-	1253,-	1318,-	1351,-	1438,-	1438,-	1547,-

Thule Omnistor 6300 - Housing color silver anodized					
Wide	325 cm	350 cm	375 cm	400 cm	450 cm
Excerpt	250 cm	250 cm	250 cm	250 cm	250 cm
Weight	25,1 kg	26,8 kg	28,5 kg	30,5 kg	31,4 kg
Mystic gray	42832	428320	428321	428322	428323
Sapphire blue	42833	428330	428331	428332	428333
Price	1280,-	1280,-	1346,-	1378,-	1465,-

Thule Omnistor 6300 - Housing color black							
Wide	260 cm	300 cm	325 cm	350 cm	375 cm	400 cm	425 cm
Excerpt	200 cm	250 cm	250 cm	250 cm	250 cm	250 cm	250 cm
Weight	20,6 kg	24,1 kg	25,1 kg	26,8 kg	28,5 kg	30,5 kg	31,8 kg
Mystic gray	42834	428340	428341	428342	428343	428344	428380
Price	1040,-	1128,-	1280,-	1280,-	1346,-	1378,-	1465,-

Motor kit for Thule Omnistor 6300

for retrofitting a 230 V tubular motor to existing awning.

White	430754	524,-
Silver anodized	430755	524,-
Black	430756	524,-

Scope of delivery for Thule Omnistor 6300 Telescopic crank, support foot attachment to the wall and pegs.

Accessories for Thule Omnistor 6300

Vehicle-specific adapter sets, absolutely necessary for mounting	Page 167
Thule awning tents QuickFit, Panorama or Residence G3	Page 179-180
Thule Windscreen, Sun- and Rainblocker	Page 176-177
Tension rods and accessories	Page 181

3. Support foot (possible from 375 cm width)
E5049 91,60

Tent and LED mounting rail

Mounting rails for mounting under the awning. For attaching awning QuickFit and simultaneous installation of LED lighting.
3 rails of 130 cm. Anthracite **43889 67,60**

LED Strip, side emitting

Special LED tape for above LED mounting rail. Side-emitting, self-adhesive. 12 V. Length 400 cm
43890 139,-

Thule Omnistor 9200 for large motorhomes and caravans



Extra large shade for extra large vehicles

- Largest extension w/ 300 cm - width up to 6 m
- Optimally suitable for many vehicle types with various adapter sets
- With integrated additional tensioning arms for high fabric tensioning

Scope of delivery Thule Omnistor 9200

Telescopic crank, support foot attachment to the wall, pegs and tension rod.

The Thule Omnistor 9200 with 230 V EM motor kit

- 230 VAC EM (= electrical-mechanical limit switch) Motor
- Remote control & control box incl.
- The control box ensures that the awning cannot be opened while driving
- Easy connection to a 230 VAC mains (if you have a 12V connection, you can use a 300 watt inverter)

Control box dims.: 160 x 92 x 51 mm, motor cable length: 5 m, power supply: 4 x 0.75 mm². EMC approved, motor w/ thermal protection.

Mounting

Be sure to order one of the adapters listed on page 166.

Accessories for Thule Omnistor 9200

Thule Panorama Awning	Page 180
Thule Residence G3 awning tent	Page 179
Thule Windscreen, Sun- and Rainblocker	Page 176 - 177

Motor kit for Thule Omnistor 9200

for retrofitting a 230 V EM motor to existing awning.

Easy programming, with control box and remote control. Description see above

White	426722	764,-
Silver anodized	426723	764,-
Cream	426724	764,-



Suitable inverter 12 V to 230 V

for connecting the awning motor to 12 volt on-board system.

Continuous power 500 W	82293	70,80
------------------------	-------	-------

Thule Omnistor 9200

Wide	400 cm	450 cm	500 cm	550 cm	600 cm
Excerpt	300 cm	300 cm	300 cm	300 cm	300 cm
Weight	41,0 kg	44,5 kg	48,0 kg	51,5 kg	55,0 kg

Housing color white

Mystic gray	428200	428210	428220	428230	428240
Sapphire blue	428202	428212	428222	428232	428242
Price	1732,-	1972,-	2201,-	2419,-	2605,-

Housing color white with 230 V EM motor*

Mystic gray	426748	426745	426749	426752	426755
Price	2354,-	2594,-	2823,-	3041,-	3226,-

Housing color silver anodized

Mystic gray	428204	428214	428223	428234	42825
Sapphire blue	428205	—	428225	428235	428250
Price	1776,-	2016,-	2245,-	2463,-	2648,-

Housing color silver anodized w/ 230 V EM motor*

Mystic gray	426743	426746	426750	426753	426756
Price	2397,-	2637,-	2866,-	3084,-	3269,-

Housing color cream

Mystic gray	42826	428260	428261	428262	—
Price	1732,-	1972,-	2201,-	2419,-	

Housing color cream with 230 V EM motor*

Mystic gray	426744	426747	426751	426754	426757
Price	2354,-	2594,-	2823,-	3041,-	3226,-

*The weight increases by approx. 3 kg

Mounting system for flat roofs

Adapters are mounted on tilting and sliding cross rails. Awning closes with roof edge or keder rail. Is screwed to the edge strip. For awning widths up to 350 cm you need 1 x Set 2, for widths from 375 cm to 400 cm you need 1 x Set 3 & for widths from 450 cm you need you need 2 x set 2.

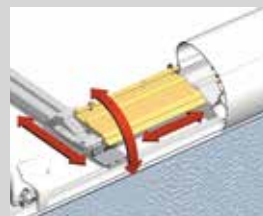

Set 2 with 2 mounting rails	43010	224,-
Set 3 with 3 mounting rails	43011	311,-

Roof mounting Adapter for panel vans and buses

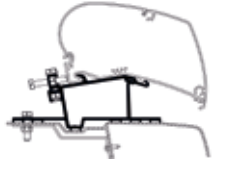

Renault/Opel
Renault Master,
Opel Movano
until YOC. 2010
2 Holder **43023 184,-**

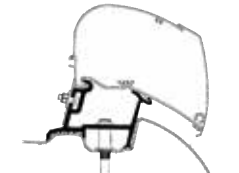

Mercedes / VW
Mercedes Sprinter from '06,
VW Crafter '06 to '17
Only for series high roof
3 Holder **43041 126,-**



VW Crafter
from YOC. 2017
Only for series high roof H2
3 Holder **43048 383,-**
UK version **43055 383,-**



Fiat / Peugeot / Citroën
Fiat Ducato,
Peugeot Boxer, Citroën Jumper
1994-2006
2 Holder **43022 174,-**



For H2
Fiat Ducato, Peugeot Boxer, Citroën Jumper from 2007, Opel Movano from 2021
Set for awning width 325 cm
3-piece. **430092 217,-**
Set for width 375 and 400 cm
4-piece. **430093 234,-**

Thule Roof Rack for Fiat Ducato from 2007 with height H2
Longitudinal crossbars with adapter for awning mounting TO 6300

- Set of 2 base rails with SmartClamps ❶ and Awning fixings ❷.
- The roof must be 10 cm from attachment points be free of obstacles to the inside.
- Mounting the SmartClamps ❶ at the original attachment points.
- The base rails ❷ are glued and connected to the SmartClamps.

Vehicle length	Awning	Item no.	Price
541 cm	3,25 m	41103	468,-
599 cm	3,75 m	41104	512,-
636 cm	4,00 m	41105	523,-



Roof girder crossbars optionally available (see carrier systems)



TO 6200
Renault Master G2
Renault Master ≥ 2010 and Opel Movano 2010 - 2021.
Master L2 = awning 325 cm
Master L3 = awning 375 cm
Master L4 = awning 400 cm
3 holders à 17,5 cm.
426780 217,-



Sealing tape self-adhesive, 25 x 30 mm, 2 x 200 cm.
For sealing between the awning and the roof.
43292 57,80

Roof mounting adapter for motorhomes and caravans



TO 9200
TO 6200
TO 6300
Flat adapter
Also prevents the passage of rainwater.
300 cm **43027 242,-**
350 cm **43028 271,-**
400 cm **43029 311,-**



TO 9200
TO 6200
TO 6300
Roof Top Adapter
For motorhomes & caravans with flat roofs, 2 x 27 cm + 2 x 50 cm.
4 Holder **430410 189,-**

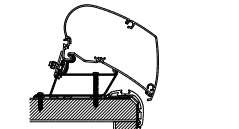

Carthago Malibu
Malibu adapter 4.50 m. Also suitable for Fendt Caravan model from 2020.
450 cm **430201 382,-**



TO 9200
TO 6200
TO 6300
Adria Roof Adapter
For caravan from model 2015, awning widths of 2-6 m.
43134 234,-



TO 9200
TO 6300
Rapido Compact
350 cm **430608 371,-**
400 cm **430609 411,-**
450 cm **430610 481,-**

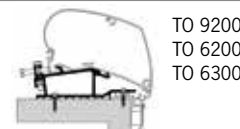

TO 9200
TO 6200
TO 6300
Hobby Caravan 2009
2 x 27 cm + 2 x 50 cm
E7013 234,-



TO 9200
TO 6200
TO 6300
Hobby Premium and Ontour
2 x 27 cm + 2 x 50 cm
E4542 234,-

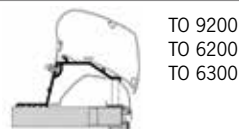

TO 9200
TO 6200
TO 6300
Hobby Caravan 2014
2 x 60 cm + 2 x 27 cm
E5488 234,-



TO 9200
TO 6200
TO 6300
Hobby Optima LED
Deluxe / Premium
2 x 50 cm + 2 x 27 cm
431103 234,-



TO 9200
TO 6200
TO 6300
Rapido Compact Integral
Adapter rail in Length 500 cm
426792 382,-



TO 9200
TO 6300
Laika Kreos
for awning width 375-500 cm.
3 Holder **426782 234,-**



TO 9200
TO 6300
Laika Ecovip
for awning width 375-500 cm.
3 Holder **426781 234,-**

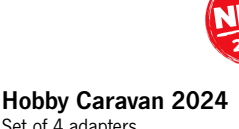

NEW 2024
Hobby Caravan 2024
Set of 4 adapters.
426790 234,-



TO 9200
TO 6200
TO 6300
Caravan Roof LED
Integrated LED channel for an optional LED. Suitable for various vehicles: eg Kabe, LeVoyageur Héritage



TO 9200
TO 6200
TO 6300
Caravan Roof
E.g. Dethleffs caravans 2014, Fendt caravans (except Brillant), also LMC & Trigano caravans
400 cm **431145 311,-**
450 cm **431146 382,-**
500 cm **431147 382,-**
550 cm **431148 457,-**



TO 9200
TO 6200
TO 6300
Hymer
Hymer 2013 caravans & motorhomes, Eriba Nova
350 cm **43114 271,-**
400 cm **431140 311,-**
450 cm **431141 382,-**
500 cm **431142 382,-**
550 cm **431143 457,-**
600 cm **431144 457,-**



TO 9200
TO 6200
TO 6300
Carthago Chic from 2014 + Malibu from 2021
400 cm **430211 311,-**
450 cm **430212 382,-**
500 cm **430213 382,-**
Until YOC. 2014
400 cm **E3741 311,-**
450 cm **43021 382,-**
500 cm **E3543 382,-**
550 cm **43109 457,-**

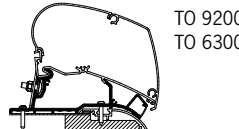

TO 9200
TO 6300
Caravan Roof LED
Integrated LED channel for an optional LED. Suitable for various vehicles: eg Kabe, LeVoyageur Héritage
425 cm **426761 397,-**
450 cm **426762 397,-**
500 cm **426763 397,-**
550 cm **426764 471,-**
600 cm **426765 471,-**



TO 9200
TO 6200
TO 6300
Rapido Distinction Roof Adapter
450 cm **43046 382,-**

You can find more adapters online

Thule Omnistor 5200 for motorhomes and Vans

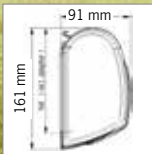

Thule Omnistor 5200

Width cm	190	230	260	300	315	350	375	400	450	500
Extract cm	140	180	200	250	250	250	250	250	250	250
Weight kg	14,2	17,0	19,0	22,6	23,4	25,4	26,7	28,0	30,4	32,8

Housing color white

Mystic gray	42600	42601	42602	42603	-	42604	-	42605	42606	42666
Sapphire blue	42607	42608	42609	42610	-	42611	-	42612	42613	42667
Price	871,-	904,-	948,-	1035,-		1133,-		1220,-	1351,-	1493,-

Housing color silver anodized

Mystic gray	42628	42629	42630	42631	-	42632	-	42633	42634	42668
Sapphire blue	-	-	-	-	-	42637	-	-	42639	426000
Price	899,-	931,-	975,-	1062,-		1160,-		1247,-	1378,-	1520,-

Housing color anthracite

Mystic gray	-	-	42650	42651	42669	42652	42678	42653	426530	426001
Price			975,-	1062,-	1160,-	1160,-	1204,-	1247,-	1378,-	1520,-

Thule Omnistor 5200 w/ 12 V motor* - housing color white

Mystic gray	-	-	-	42595	-	42599	-	42596	42597	426002
Price				1438,-		1536,-		1624,-	1754,-	1896,-

*The total weight of the awning with the motor increases by approx. 1 kg



Thule Subsula
The new triangular sails for the TO5200 in width 260 cm can be found on page 175.



Only with Thule Omnistor 5200



Thule Pitch System
The adjustable drop angle on Thule Omnistor 5200's hinged arms allows awning to be extended & retracted even when door is open.



Optimal closure
Another new feature is a simple cloth roller adjustment for perfect closing on the opposite side of the gearbox.



	White	Silver	Anthra-cite	
300 cm	43149	431490	431491	130,-
350 cm	431492	431493	431494	130,-
400 cm	431495	431496	431497	141,-
450 cm	431498	431499	-	147,-

Fast shade for caravans, compact motorhomes and vans

- Extension up to 2.50 m, width up to 5.00 m
- Housing with integrated rain gutter
- Robust and stable articulated arms with failure setting
- Thule Pitch System - Freely adjustable dropout angle
- Optimum fabric tension due to additional clamping arms (from 400 cm series, for 300 cm & 350 cm retrofittable w/ part no. 432960)
- Third support foot can be mounted optionally
- Cloth roll adjustment for perfect closure

Accessories for Omnistor 5200

Adapter sets for special mounting situations p. 172-173
Thule awning tents p. 178-180 Thule Windscreen, Sun- & Rainblocker p. 176-177 Thule tensioning poles p. 181

Additional Clamping arm set
for 300 cm and 350 cm **432960 48,-**

Additional support foot,
recommended from 350 cm **E5049 91,60**

Scope of delivery of Thule Omnistor 5200
3 or 4 adapters, depending on width of the awning, for attachment to a vertical vehicle wall, telescopic crank, support foot attachment to d. Wall, pegs & tension rod.

12 Volt motor kit for Thule Omnistor 5200 for retrofitting to the existing awning. Width + 3 cm, weight + 600 g.
White **430751 524,-**
Silver anodized **430752 524,-**
Anthracite **430753 524,-**

Tent & LED mounting rail for Thule Omnistor 5200 for mounting under the awning. With keder rail for attaching tent EasyLink or QuickFit & mounting place for LED light strips.



Thule Omnistor 8000 for large motorhomes and caravans

Noble wall awning with large extension for large motorhomes and caravans

- Largest extension of up to 275 cm - width up to 600 cm
- Housing in white, anodized or cream
- With integrated additional tensioning arms for high fabric tensioning
- Optional motor kit w/ remote control is available

Scope of delivery of Thule Omnistor 8000

3 or 4 adapters, depending on the length of the awning, for attachment to a vertical vehicle wall, telescopic crank, support foot attachment to the wall, pegs and tension rod.

Thule Omnistor 8000 w/ 230 V EM motor kit

- 230 VAC EM (= electrical-mechanical limit switch) Motor
- Remote control & control box incl.
- The control box ensures that awning cannot be opened while driving
- Easy connection to a 230 VAC mains (for a 12V connection you can use a 300 Watt inverter)

Control box dims.: 160 x 92 x 51 mm, motor cable length: 5 m, power supply: 4 x 0.75 mm². EMC approved, motor w/ thermal protection.

Accessories for Thule Omnistor 8000

Adapter sets for special mounting situations	S. 172-173
Thule QuickFit awning tent	S. 178
Thule Panorama Awning	S. 180
Thule Residence G3 awning tent	S. 179
Thule Windscreen, Sun- and Rainblocker	S. 176-177

Motor kit for Thule Omnistor 8000

Description see above

Motor Kit 230 Volt EM White	426718	764,-
Motor kit 230 Volt EM silver anodized	426719	764,-
Motor Kit 230 Volt EM Cream	426720	764,-
Motor kit 230 Volt EM Anthracite	426721	764,-

Suitable inverter 12 V to 230 V

for connecting the awning motor to 12 volt on-board system.

Continuous power 500 W	82293	70,80
------------------------	--------------	--------------

Thule Omnistor 8000

	400 cm	450 cm	500 cm	550 cm	600 cm
Wide	400 cm	450 cm	500 cm	550 cm	600 cm
Excerpt	275 cm	275 cm	275 cm	275 cm	275 cm
Weight	41,4 kg	44,6 kg	48,2 kg	51,8 kg	55,4 kg

Housing color white

Mystic gray	4323610	4323640	432370	4323600	4323602
Sapphire blue	4323620	4323650	4323670	4323350	-
Price	1558,-	1743,-	2049,-	2212,-	2376,-

Housing color white with 230 V motor*

Mystic gray	426725	426728	426731	426735	426739
Price	2179,-	2365,-	2670,-	2833,-	2997,-

Housing color silver anodized

Mystic gray	4323810	432383	432389	4323800	4323802
Sapphire blue	-	432386	4323870	-	-
Price	1602,-	1787,-	2092,-	2256,-	2419,-

Housing color silver anodized w/ 230 V motor*

Mystic gray	426726	426729	426732	426736	426740
Price	2223,-	2408,-	2714,-	2877,-	3041,-

Housing color cream

Mystic gray	432355	432356	432357	432358	432359
Price	1558,-	1743,-	2049,-	2212,-	2376,-

Housing color Cream w/ 230 V motor w/ 230 V motor*

Mystic gray	426727	426730	426733	426737	426741
Price	2179,-	2365,-	2670,-	2833,-	2997,-

Housing color anthracite with 230 V motor*

Mystic gray	-	-	426734	426738	426742
Price			2714,-	2877,-	3041,-

*The total weight of awning with motor increases by app. 2 kg



Motor kit for Thule Omnistor 8000

Thule Omnistor 4200 – Lightweight awning for compact vans

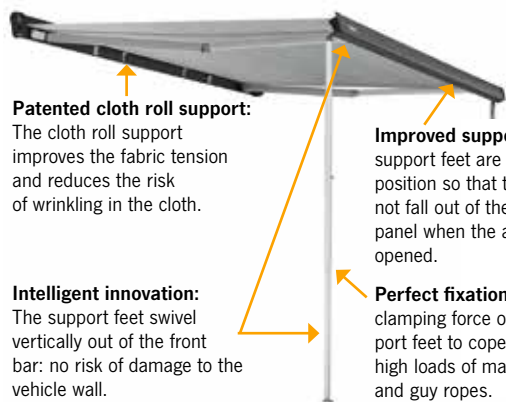

Patented cloth roll support:
The cloth roll support improves the fabric tension and reduces the risk of wrinkling in the cloth.

Improved support: The support feet are held in position so that they do not fall out of the front panel when the awning is opened.

Intelligent innovation:
The support feet swivel vertically out of the front bar: no risk of damage to the vehicle wall.

Perfect fixation: Strong clamping force of the support feet to cope with the high loads of mark- tents and guy ropes.

Adapter selection
Mounting example of a Multitrail-Adapter on the REIMO Multitrail



Thule Omnistor 4200		
Width cm	260	300
Extract cm	200	250
Weight kg	17,5	19,7
Housing color white		
Mystic gray	426771	426773
Price	809,-	883,-
Housing color silver anodized		
Mystic gray	426772	426774
Price	809,-	883,-
Housing color anthracite		
Mystic gray	426700	426701
Price	850,-	926,-

TO 4200

- Suitable for a wide range of compact vans
- Special removable adapters for the REIMO Multitrail
- Perfect fixation of the support feet
- Stowage of the support feet in the front panel
- Lightest in its category: 17.5 kg for 2.60 m length

Scope of delivery:

Awning TO 4200 in width 260 cm or 300 cm with crank. Suitable, vehicle-specific adapters must be ordered separately. Case: White, Silver or Anthracite, Cloth: Mystic Gray.

Accessories for Omnistor 4200:

Vehicle specific adapters	Page 172-173
REIMO Multitrail	Page 105
Thule Residence G3 awning tent	Page 179
Thule Sun and Rain Blocker	Page 176-177
Thule Windscreen	Page 177
Thule Subsola triangular sail	Page 175

- Thule Rainblocker complete set**
to extend the awning (width 260 cm) to the awning.
Scope of delivery: 2x Rainblocker Front XS, W 130 cm, H 185 cm, 2x Rainblocker Side XS, transport bag
Weight approx. 11 kg
 - Rain Blocker G2 Front - front wall with window**
 - Rain Blocker G2 Side - Side panel with window**
 - Sun Blocker G2 Front - front wall mesh fabric**
- | Item no. | Price |
|----------|--------|
| 43089 | 801,- |
| 42925 | 1935,- |
| 430841 | 168,- |
| 430883 | 272,- |
| 430873 | 136,- |
| 430874 | 163,- |
- not shown. **View Blocker Front - front wall without window**
- | Item no. | Price |
|----------|-------|
| 430822 | 152,- |



Mounting adapter THULE 3200

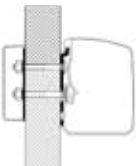

Wall Adapter Flat Wall
Also suitable for UK.
42688 61,10

Roof adapter Roof Rack
Also suitable for UK.
42689 107,-



VW T5/T6 Fixed
For fixed mounting on the VW bus.
42690 151,-
UK 42696 151,-



VW T5/T6 Multirail
For mounting on the REIMO Multirail.
KR 42691 207,-
KR UK 42697 207,-
LR 426911 215,-
LR UK 426971 215,-



VW T5/T6 Brandrup
For mounting on a Brandrup rain gutter.
42692 185,-



Citroën Spacetourer
Peugeot Traveller, Toyota Verso & Opel Zafira D.
42693 185,-
UK 42699 185,-



Ford Custom
Fixed mounting on Ford Transit/Tourneo Custom.
42694 185,-
UK 42679 185,-



Renault Traffic
Fixed mounting also on Vivaro/Talento/NV300. Also suitable for UK.
42695 141,-

More adapters on the next page



Thule Omnistor 3200 for Vans and camper vans

- Very large extension of 250 cm
- Small cassette with light weight
- Manually unrollable - one-man operation
- Cloth tensioning system w/ ratchet technology
- Soft, water-repellent cloth made of polypropylene.
- Quick Lock system for variable height adjustment of support feet

THULE 3200

Wide	190 cm	230 cm	250 cm	270 cm	300 cm
Excerpt	250 cm	250 cm	250 cm	250 cm	250 cm
Weight	12,0 kg	13,8 kg	14,7 kg	15,6 kg	16,9 kg

Accessories for THULE 3200:
Thule Sun and Rain Blocker
Page 176-177

Housing silver anodized

Uni gray	—	—	426800	426801	426802
Price			708,-	730,-	752,-

Housing Black

Uni gray	426803	426804	426805	426806	426807
Price	686,-	708,-	730,-	752,-	773,-

Scope of delivery:

Awning for manual operation. A vehicle-specific adapter is required for mounting (please also order).

**Thule Omnistor 5102
Special awning for VW T5/T6/T6.1**



For T5/T6 Transporter or Multivan

- For VW Multivan or Transporter from YOC. 2003*
- With 90 cm long crank adapted to the height of the vehicle - quick to extend
- For flat roof with C-rail on the roof
- Rail can also be retrofitted (available from Volkswagen dealers)

Thule Omnistor 5102

Wide	260 cm
Excerpt	200 cm
Weight	19,8 kg
Housing anthracite	426714 959,-
Housing light gray	426715 959,-

Accessories for Omnistor 5102:

Thule Residence G3 awning tent for Volkswagen Transporter/Multivan T5/T6

Color gray	433012	1935,-
Thule awning Residence		Page 179
Thule Sun and Rain Blocker		Page 176-177
Thule Windscreen		Page 177
Thule Subsola triangular sail		Page 175

Scope of delivery: Awning w/o. adapter.

*Not suitable for vehicles with high or pop-up roof.



If VW Original rail not available, please purchase via VW.

Adapter

VW T5/T6/T6.1 LHD	426716	151,-
VW T5/T6/T6.1 RHD	426717	151,-
Hymer Car 302 - Ducato H1	E3758	132,-

Wall mounting Adapter for motorhomes and caravans

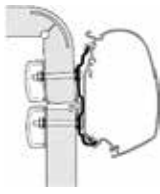

TO 4200
TO 5200
TO 8000

Hymer 2016
400 cm **430634** 311,-
450 cm **E10323** 382,-

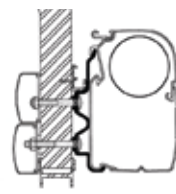

TO 4200
TO 5200
TO 8000

Hymer C-Camp ≤ 2011
300 cm **E1691** 242,-
350 cm **43101** 271,-
400 cm **43102** 311,-
450 cm **43104** 382,-
500 cm **43103** 382,-
550 cm **43100** 457,-

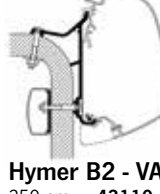

TO 4200
TO 5200
TO 8000

Hymer B2 - VAN
350 cm **43110** 271,-
400 cm **43111** 311,-
450 cm **43112** 382,-
500 cm **43113** 382,-



TO 4200
TO 5200

Eriba Touring until YOC. 07
3x4 cm
3 Holder **43108** 141,-



TO 5200

Bürstner 2017
2x40 cm + 2x8 cm
4 Holder **43007** 118,-

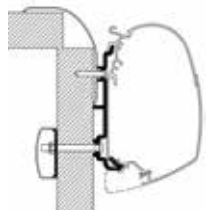

TO 5200
TO 8000

Wall adapter Frankia
350 cm **430601** 271,-
400 cm **430602** 311,-
450 cm **430603** 382,-
500 cm **430604** 382,-
550 cm **430605** 457,-
600 cm **430606** 457,-



TO 4200
TO 5200
TO 8000

Dethleffs Globebus
300 cm **430790** 51,30
350 cm **43079** 66,50
400 cm **43080** 87,20
> 400 cm **430801** 87,20



TO 4200
TO 5200
TO 8000

Carado / Sunlight
1x17,5cm + 1x40cm + 1x4cm
3 Holder **43135** 188,-

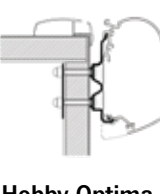

TO 5200

Hobby Optima Ontour
2x40 cm + 2x8 cm
4 Holder **43008** 173,-



NEW 2024

TO 5200

Knaus Tourer CUV
300 cm **426791** 242,-

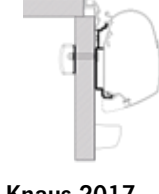

TO 5200

Knaus 2017
2x17,5 cm + 2x4 cm
4 Holder **43005** 118,-



TO 5200

Knaus Deseo
350 cm **43006** 444,-



TO 4200
TO 5200

Bailey
Awning width 400-450 cm,
not for motorhome Autograph
81-6, for caravans only w/ TO
4200, 5 holders à 15 cm.
426783 175,-



TO 4200
TO 5200
TO 8000

Rapido 7
3 Holder **SA655** 188,-
300 cm **E1507** 242,-
400 cm **SA174** 311,-
500 cm **E4577** 382,-

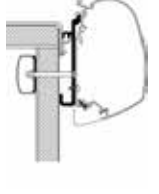

TO 4200
TO 5200
TO 8000

Rapido 9
4 Holder **SA444** 99,20

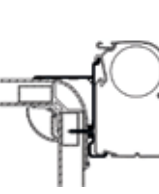

TO 4200
TO 5200
TO 8000

Pilote Explorateur
400 cm **E2957** 311,-

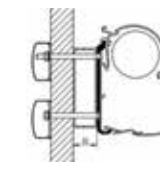

TO 4200
TO 5200
TO 8000

Eden / Allegro ≥ 2010
3 Holder **43004** 141,-

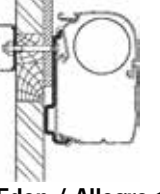

TO 4200
TO 5200
TO 8000

Eden / Allegro ≤ 2010
3 Holder **E8782** 141,-
400 cm **E8074** 311,-



TO 5200

Ducato H2 Lift Roof
315 cm **430637** 359,-
375cm **430638** 392,-
400 cm **430639** 392,-



TO 3200
TO 4200
TO 5200

Fiat until YOC. 2006
Fiat Ducato,
Peugeot Boxer,
Citroen Jumper
for series high roof H2
3 Holder
426786 114,-

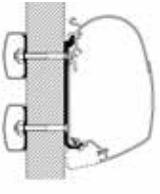

TO 4200
TO 5200
TO 8000

Universal Flat Adapter
5 x 40 cm **430415** 159,-
5 x 75 cm **E7099** 175,-
300 cm **SA865** 215,-
400 cm **430416** 276,-
500 cm **430417** 343,-
600 cm **E4957** 407,-

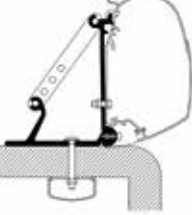

TO 3200
TO 4200
TO 5200

Omni Roof
Universal roof adapter
for mounting on the roof of
motorhomes / caravans,
3 x 8 cm
3 Holder **426785** 141,-

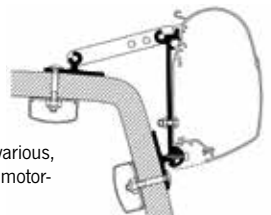

TO 3200
TO 4200
TO 5200

Omni Wall
Universal adapter for various,
universal attachment to motor-
homes / caravans,
2 x 8 cm + 1 x 4 cm
3 Holder **426784** 136,-

Wall mounting Adapter for panel vans and buses



TO 3200
TO 4200
TO 5200

Brandrup T4/T5/T6 Brandrup Rail, for special rain gutter. 2 holders à 8 cm.

43025 124,-

Also suitable for UK TO 4200 TO 5200



VW T4 Brandrup Rail G2 to screw on

430607 185,-

Also with folding sleeping roof TO 4200

Adapter for the Reimo Multirail

For Volkswagen T5/T6/T6.1:

Short wheelbase	426704	207,-
Long wheelbase	426706	215,-
UK short wheelbase	426705	207,-
UK long wheelbase	426707	215,-

Mercedes Vito 426766 348,-

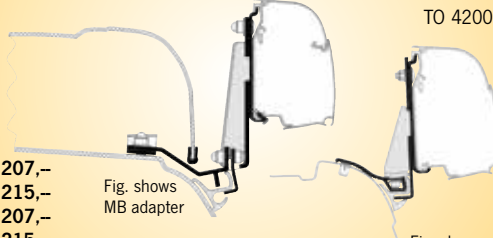



Fig. shows MB adapter

Fig. shows VW adapter



TO 3200
TO 4200
TO 5200

VW T4 Sleeping roof adapter 2 holders à 8 cm.

43026 132,-



TO 4200
TO 5200

VW T4 to screw on, 2 holders à 8 cm.

426789 132,-

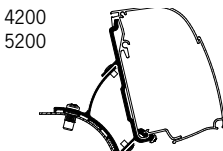

TO 4200
TO 5200

VW T4/T5 Minivan Fixed For sleeping roof

	426702	151,-
UK	426703	151,-



TO 4200

Westfalia Kepler Five/One/Six Five = awnings 260 cm One & Six = awning 300 cm

426712 185,-



TO 3200

Westfalia Kepler Five/One/Six Five = 270 cm One & Six = 300 cm

426758 185,-



TO 4200
TO 5200

VW T2 / T3 3 holders: 2x8 cm + 1x4 cm

426788 174,-

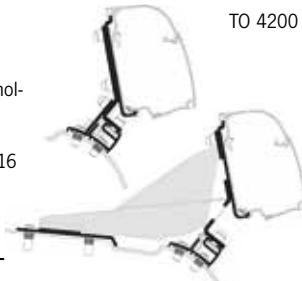

TO 4200

PSA Minivan G2 for vehicle length 495 cm, 2 holders, awning width 260 cm, Peugeot Traveller/Expert ≥ 16 Citroën Spacetourer/Jumpy ≥ 16 Fiat Scudo ≥ 16 Toyota Proace (Verso) ≥ 16 Opel Zafira/Vivaro ≥ 19

	426778	207,-
UK	426779	207,-

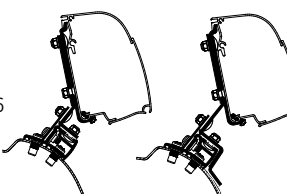

TO 5200

PSA Minivan Fixed Peugeot Traveller/Expert ≥ 16 Citroën Spacetourer/Jumpy ≥ 16 Fiat Scudo ≥ 16 Toyota Proace (Verso) ≥ 16 Opel Zafira/Vivaro ≥ 19

	426708	185,-
UK	426709	185,-



TO 3200
TO 4200
TO 5200
TO 8000

Renault / Opel Adapter Renault Master until 2010, Opel Movano Series high roof from YOC. 1998, 3 Holder

426787 215,-

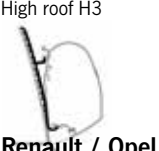

High roof H3 TO 4200 TO 5200 TO 8000

Renault / Opel Adapter Renault Master until YOC. 2010, Opel Movano w/ high roof. 2 holders à 50 cm

430630 151,-

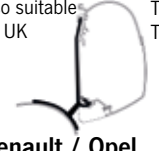

Also suitable for UK TO 4200 TO 5200

Renault / Opel Renault Trafic all model years, Opel Vivaro until 2019. With and without pop-up roof. Awning width max. 260 cm 2x50 cm.

43105 141,-



TO 4200
TO 5200

Westfalia adapter For vehicles with high roof and side mounting points. 3 holders à 8 cm.

430633 111,-



TO 4200
TO 5200

Westfalia Ford Nugget 2 holders à 12 cm. For awning 260 cm.

430600 111,-

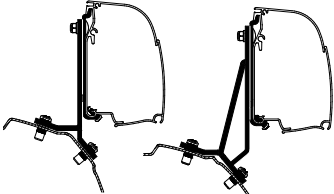

TO 4200
TO 5200

Ford Transit/Tourneo Custom Minivan Fixed

	426710	185,-
UK	426711	185,-

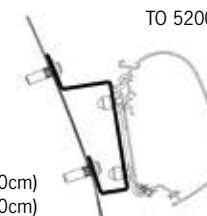

TO 5200

Ford Transit H3 for Transit ≥ 2014, 3 holder Awning width 300 cm for Transit L2 (550cm) Awning width 350 cm for Transit L3 (600cm) Awning width 400 cm for Transit L4 (670cm)

	426776	215,-
UK	426777	215,-

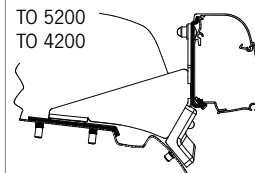

TO 5200
TO 4200

Mercedes Vito/V-Class with SCA pop-up roof 152 For awnings 260 cm

426713 207,-



TO 4200
TO 5200

Fiat Ducato & Iveco Adapter Fiat Ducato H2 w/ folding sleeping roof. 3 holder à 17,5 cm

430631 188,-



TO 4200
TO 5200

Fiat from YOC. 2007 - H3 Adapter Fiat Ducato and similar with H3 series roof. Incl. Sealing tape. 3 holders: 2x50 cm + 1x10 cm

430632 151,-



TO 4200
TO 5200
TO 8000

Ford Transit High roof adapter, 3 holders: 2x50 cm + 1x50cm

E2069 99,20

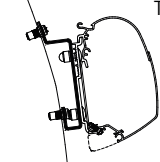

TO 5200

Ford Transit High roof adapter, For H3 - 2014,

426759 188,-

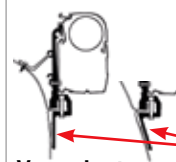

TO 3200
TO 4200
TO 5200

Van adapter 2 angles possible

For vehicles with rain gutter, 2 holders each 4 cm & 8 cm. Incl. 2 different angles.

43051 132,-

Thule Omnistor 1200
large pullout in compact envelope

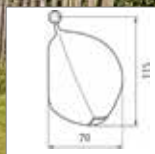

THULE Omnistor 1200 - Caravan awning in a case

- Attachment by pulling into the keder rail
- Toolless assembly
- Easy and fast set up
- Support legs and clamping arms in front bar
- Cover and cloth made of high quality PVC
- New type of fabric tensioning system w/ ratchet
- Additional support foot for awnings from 400 cm

The Thule Omnistor 1200 is an extremely lightweight and strong pocket awning in compact PVC cover with sewn piping and zipper. The assembly is done simply by pulling in the Bag into the welt rail - without tools, without drilling.

Wide	230 cm	260 cm	300 cm	325 cm	350 cm	375 cm	400 cm	425 cm	450 cm	500 cm	550 cm
Excerpt	200 cm	220 cm	250 cm	250 cm	250 cm	250 cm	250 cm	250 cm	250 cm	250 cm	250 cm
Weight	9 kg	10,4 kg	12 kg	12,6 kg	13,4 kg	14,2 kg	15 kg	15,3 kg	16,6 kg	18,4 kg	20 kg
Mystic gray	42416	42400	42402	42404	42406	42408	42410	42412	42414	42418	42420
Sapphire blue	42417	42401	42403	-	42407	42409	42411	42413	42415	42419	42421
Price	577,-	588,-	599,-	610,-	632,-	653,-	697,-	741,-	795,-	850,-	904,-



Support Kit
The pressure of the clamping arms is evenly distributed on the caravan wall.



Cloth tensioning system
Perfect tension of the cloth with the help of the new ratchet technology



Additional support foot additional for awnings from 4 m
E5049 91,60

Accessories for Thule Omnistor 1200

Thule QuickFit awning tent	S. 178
Thule Sun- and Rainblocker	S. 176-177
Tie rods and accessories	S. 181



Photo shows Thule Omnistor 1200 w/ awning QuickFit



Thule Subsola
modular awning extension



THULE Subsola - modular panels for more living space

- Developed for small vans and buses
- For more living space with the awning
- for more privacy, perfect weather protection

The Thule Subsola Tarps are compatible with the following Thule awnings:

- Thule Omnistor 4200
- Thule Omnistor 4900
- Thule Omnistor 5102
- Volkswagen awning from T5/T6 California
- Thule Omnistor 5200 w/ width 260 cm & extension 200 cm

Thule Subsola are made of breathable & water-resistant material & offer protection from sun and rain. They have high-quality zippers and piping and can therefore be fastened and combined in different ways. Suitable for mounting heights from 190 to 224 cm. Color: Vapor Grey.

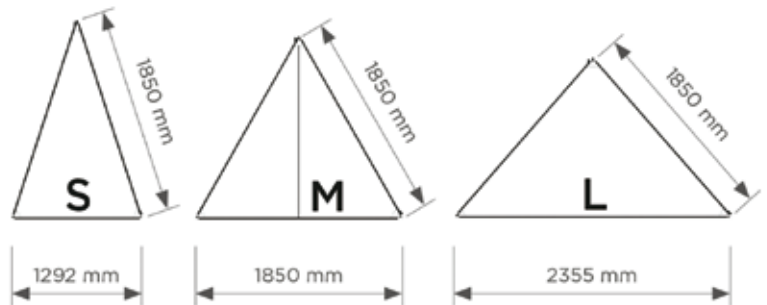

Thule Subsola side package

- consisting of:
- 2 x Subsola Medium-Panel (M)
 - 1 x Subsola Small-Panel (S)
 - 1 x tension rod
 - 1 x support bar
 - Guy ropes, pegs and bag

Weight: approx. 4.5 kg
Pack size: app. 80 x 16 x 16 cm



430892 457,-

Thule Subsola front package

- consisting of:
- 1 x Subsola Large-Panel (L)
 - 1 x Subsola Medium panel (M)
 - 1 x support bar
 - Guy ropes, pegs and bag

Weight: app. 3.0 kg
Pack size: approx. 31 x 6 x 6 cm

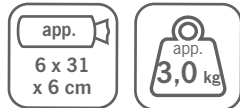

430893 294,-



Thule Subsola Medium panel (M)

- consisting of:
- 1 x Subsola Medium panel (M)

430894 141,-

Thule Subsola Support rod

- consisting of:
- 1 x extension pole L approx. 240 cm, telescopic

430895 75,30





Modular, combinable blocker system G2

- Side parts (Side) incl. aluminum tension rod for fastening
- With keder profile for retracting the side wall
- Delivery includes pegs and guy ropes
- Front wall (front) is pulled into the keder rail of the awnings

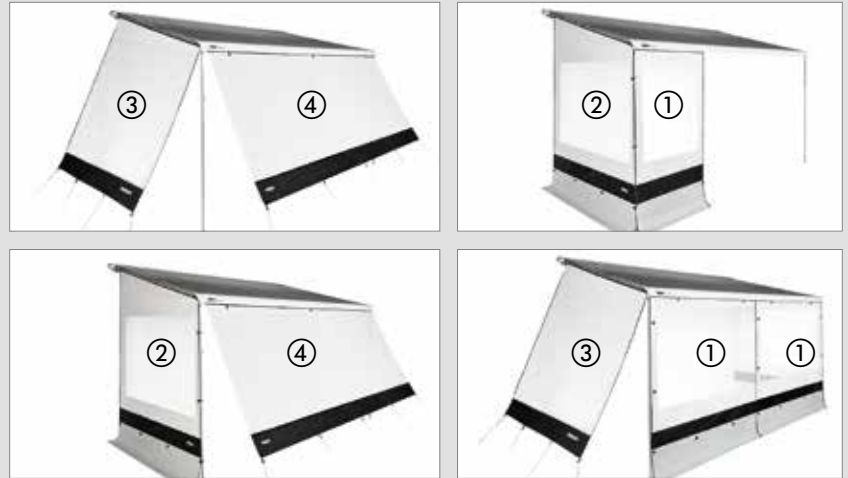
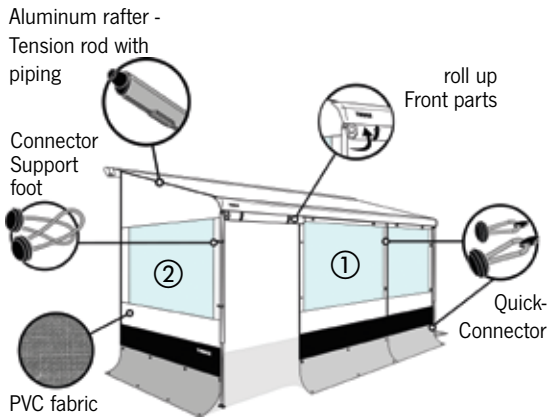

Sun Blocker G2

- Lightweight translucent mesh fabric
- Protection against sun rays
- Side panels incl. aluminum tension rod for fastening w/ keder profile for retracting side panel

③ Sun Blocker G2 Side - side panel

Awning type	Excerpt Type	Mounting height	Item no.	Price
T 3200 (Van/SUV)	250 cm XS	180 -199 cm	430802	256,-
TO 5200/5003/5102/6200/6300	200 cm S	190 -224 cm	430880	256,-
TO 5200/5003/6200/6300	250 cm M	225 -244 cm	430851	256,-
TO 5200/5003/6200/6300	250 cm L	245 -264 cm	430852	256,-
TO 6900/8000	275 cm M	225 -244 cm	430853	277,-
TO 6900/8000	275 cm L	245 -264 cm	430854	277,-
TO 9200	300 cm M	225 -244 cm	430855	310,-
TO 9200	300 cm L	245 -264 cm	430856	310,-
TO 1200	250 cm M	225 -249 cm	430882	256,-

④ Sun Blocker G2 Front - Front Wall

Awning type	Wide	Height	Item no.	Price
	100 cm	170 cm	430873	136,-
	240 cm	170 cm	430874	163,-
for all	280 cm	170 cm	430875	179,-
Thule Omnistor	330 cm	170 cm	430876	196,-
Awnings	380 cm	170 cm	430877	207,-
	430 cm	170 cm	430878	217,-
	480 cm	170 cm	430879	239,-



View Blocker perfect Privacy screen

- Protection against Rain, Wind & Sun
- Made of weatherproof PVC
- Side panels incl. aluminum tension rod for fastening w/ keder profile for retracting side panel

⑤ View Blocker Side - side panel

Awning type	Excerpt Type	Mounting height	Item no.	Price
TO 5200/5003/6200/6300	200 cm S	205-224 cm	430887	272,-
TO 5200/5003/6200/6300	250 cm S	205-224 cm	430888	272,-
TO 5200/5003/6200/6300	250 cm M	225-244 cm	430831	272,-
TO 1200/5200/5003/6200/6300	250 cm L	235-254 cm	430886	272,-
TO 5200/5003/6200/6300	250 cm L	245-264 cm	430832	272,-



⑥ View Blocker Front - Front panel

Awning type	Wide	Height	Item no.	Price
	240 cm	140 cm	430822	152,-
	280 cm	140 cm	430823	157,-
for all	330 cm	140 cm	430824	163,-
Thule Omnistor	380 cm	140 cm	430825	168,-
Awnings	430 cm	140 cm	430826	201,-
	480 cm	140 cm	430827	223,-

Thule Windscreen - Wind protection for all awning types

Self rolling windbreak made of easy-care PVC fabric.

150 cm high and extendable up to 300 cm. Quickly attaches the windshield to the support leg wall bracket or vehicle keder rail. Simply unroll and attach to awning support foot or free-standing with the supplied bracing set set up.

Includes carrying bag and Mounting material, guy ropes and herrings.

Weight 4,5 kg

Pack size 160 x 10 x 12 cm

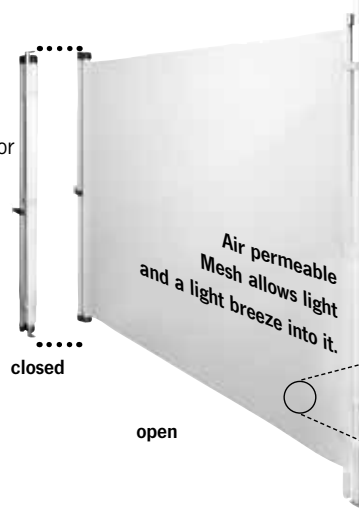

44590

256,-

Usable for all types of awnings



Rain Blocker G2 Front parts

- Made of waterproof PVC with large window
- St protects from sun, wind and rain
- Different width front parts can be combined with each other

① Rain Blocker G2 Front - Front wall

Awning type	Wide	Height	Item no.	Price
Combinable with Side XS	112 cm	185 cm	430804	163,-
Suitable also	127 cm	185 cm	430841	168,-
for T 3200	147 cm	185 cm	430806	179,-
and TO 4200	181 cm	185 cm	430807	201,-
	125 cm	210 cm	430842	168,-
Combinable with	150 cm	210 cm	430843	179,-
Side S and TO 1200	175 cm	210 cm	430844	201,-
	200 cm	210 cm	430845	217,-
	100 cm	230 cm	430857	157,-
Combinable with	150 cm	230 cm	430858	179,-
Side M, L, XL, XXL	175 cm	230 cm	430859	201,-
and G2C (Caravan)	200 cm	230 cm	430860	217,-

also for Volkswagen T5/T6



Rain Blocker G2 Side panels

- Made of waterproof PVC w/ panoramic window
- St protects from sun, wind and rain
- Side panels incl. aluminum tension rod for fastening w/ keder profile for retracting side panel

② Rain Blocker G2 Side - side panel

Awning type	Excerpt	Type	Mounting height	Item no.	Price
T 3200 (Van/SUV)	250 cm	XS	180 -199 cm	430803	272,-
TO 5200/4200/5102/VW California	200 cm	XS	180 -199 cm	430883	272,-
TO 5200/5003/5102/6200/6300	200 cm	S	205 -224 cm	430881	272,-
TO 5200/5003/6200/6300	250 cm	S	205 -224 cm	430861	272,-
TO 5200/5003/6200/6300	250 cm	M	225 -244 cm	430862	272,-
TO 5200/5003/6200/6300	250 cm	L	245 -264 cm	430863	272,-
TO 5200/5003/6200/6300	250 cm	XL	265 -284 cm	430864	272,-
TO 5200 Fiat Ducato H2	250 cm		230 -250 cm	430891	272,-
TO 5200 Ford Transit H3	250 cm		245 -264 cm	430890	294,-
TO 6200/6300 (Caravan)	200 cm	G2C	235 -254 cm	430889	272,-
TO 6200/6300 (Caravan)	250 cm	G2C	235 -254 cm	430800	272,-
TO 8000	275 cm	M	225 -244 cm	430865	294,-
TO 8000	275 cm	L	245 -264 cm	430866	294,-
TO 8000	275 cm	XL	265 -284 cm	430867	294,-
TO 8000	275 cm	XXL	285 -304 cm	430884	294,-
TO 9200	300 cm	M	225 -244 cm	430868	326,-
TO 9200	300 cm	L	245 -264 cm	430869	326,-
TO 9200	300 cm	XL	265 -284 cm	430870	326,-
TO 9200	300 cm	XXL	285 -304 cm	430885	326,-
TO 6200/6300 - Fiat Ducato	250 cm		230 -250 cm	430872	272,-

Awning QuickFit
also for FIAT Ducato
on page 164

Quick pitch tent to hang under

- Universal fit - suitable for almost any type of awning
- Light weight, small pack size
- Is hung under the awning, creating a double insulating roof
- Round arch canopy protects during rain
- Includes floor skirt, curtains & bag
- Front window can be opened completely

Scope of delivery:

Tent, pack bag (measure app. 70 x 35 x 35 cm),
pegs, Curtains & windbreak to prevent drafts under
the vehicle.



Only **15** minutes assembly time

Thule QuickFit

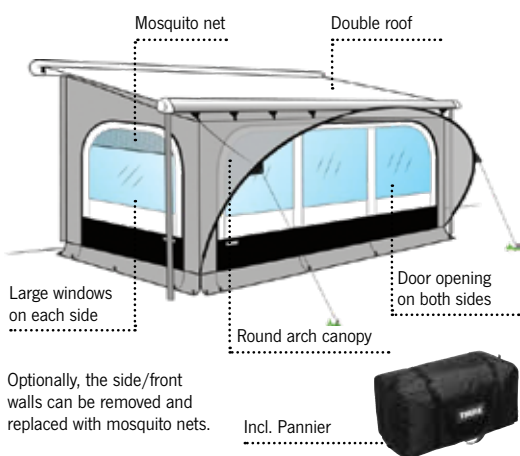

Thule QuickFit - awning tent for ultrafast assembly

Tent width	Mounting height	in cm	for awning width	Weight	Item no.	Price
260 cm	Medium	225 – 244	300 cm	15,7 kg	43214	970,-
260 cm	Large	245 – 264	300 cm	16,1 kg	432140	991,-
260 cm	Extra-Large	265 – 284	300 cm	16,4 kg	4321411	1013,-
310 cm	Medium	225 – 244	350 cm	16,7 kg	432148	1002,-
310 cm	Large	245 – 264	350 cm	17,1 kg	432149	1024,-
310 cm	Extra-Large	265 – 284	350 cm	17,4 kg	4321412	1046,-
360 cm	Medium	225 – 244	400 cm	17,7 kg	432141	1035,-
360 cm	Large	245 – 264	400 cm	18,1 kg	432142	1057,-
360 cm	Extra-Large	265 – 284	400 cm	18,4 kg	4321413	1079,-

Assembly note

Mounting is possible under the awning if ...
... a roof or wall awning is installed and an 8 mm keder rail is still accessible underneath.
... an awning is installed and there is no keder rail underneath. However, then a Mounting set necessary.

Accessories for awning QuickFit

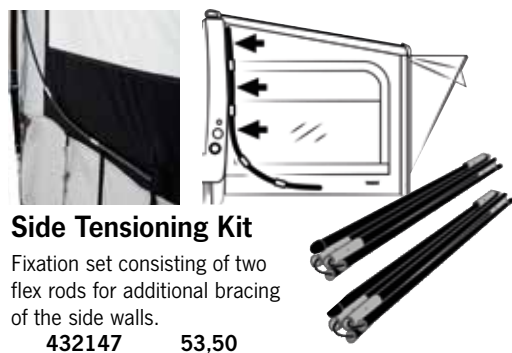

Side Tensioning Kit

Fixation set consisting of two flex rods for additional bracing of the side walls.
432147 53,50



The windows can be replaced with mosquito inserts.
How to create an airy living space

Mosquito net inserts

for side wall	432150	190,-
for front wall 260 cm	4321501	217,-
for front wall 300/310 cm	4321502	228,-
for front wall 360 cm	4321503	239,-

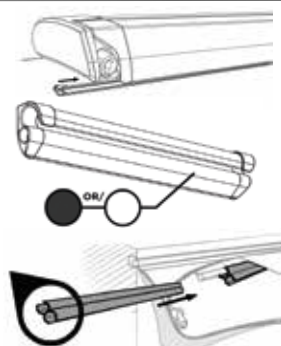

Mounting sets QuickFit

...Roof awnings
Thule Omnistor 6200, 6300 and 9200 up to 400 cm wide.
3 rails à 130 cm

432143 53,50

Side wall awnings

Keder rail in 400 cm length
White **4321430 53,50**
Anthracite **4321431 53,50**

...Caravan awnings

Thule Omnistor 1200 to 450 cm
Awning width **4321471 53,50**

Mounting kit for awnings with extension over 250 cm

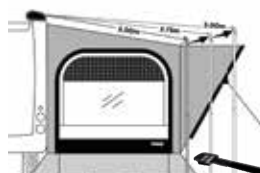

For mounting on awnings with an extension 275 cm to 300 cm. The greater distance is bridged with this set.
8 parts **432146 31,70**

Mounting set for FIAMMA awnings



Special set for mounting the tent on Fiamma awnings.
8 parts. **4321470 31,70**

Thule Residence G3

Exclusive awning blind

- **High quality cloth material made of PVC**
Excellent PVC cloth quality for optimal wind and water resistance in colors black, gray and white.
- **Robust sealing**
A profile with double rubber lips creates a perfect seal between the vehicle wall and the tent walls. Thanks to connecting profiles, front and side walls can be combined to form a closed tent.
- **Installation**
A clamping profile ensures the connection of the side wall with the awning cloth for a perfect roof seal. The side panels slide into the clamping profile, the front panel is pulled into the front profile of the awning. From a width of 350 cm, the door can be used on the left or right.
- **Protection**
Side windows are fitted w/ a window film that can be opened w/ a zipper from the outside. For insect protection, a fly gauze is standard on both side walls.



Incl. Packing bags for tent skin, poles & accessories



Color combination



- 1 Incl. Windshield and Wheel cover
- 2 Side windows w/ mosquito nets and foil cover
- 3 Front wall w/ door right or left from width 350 cm
- 4 Windows in front and door can be rolled up
- 5 Piping on front to accommodate accessories, such as Sun Blocker

DUC = sizes for Fiat Ducato H2
FT = sizes for Ford Transit H3

Residence G3 for Eriba Touring



Complete tent

A true outdoor living room. Special model for an Eriba Touring caravan in combination with Thule Omnistor 6300 roof awning (for 325 cm). Incl. Wind skirt, wheel cover and pannier.

433010 2153,-

Residence G3 for VW T5/T6 - also California / MB Vito



Complete tent

for mounting VW T5/T6 Transporter or California with short wheelbase or MB Vito. Front, side panels and all mounting parts. Width 260 cm.

for TO 5102 433012 1935,-
for TO 4200 42925 1935,-

Accessories for Thule Residence G3:

Curtain sets	see below
Thule Sun Blocker Front G2	S. 177
Windshield (as a replacement)	S. 181
Connection profiles for accessories	
Double piping 6 x 1m	42908 60,-

Side walls (in pairs, only for vehicles with straight walls)

Mounting height Awning	TO 5003/5200		TO 6200/6300		TO 6900		TO 8000		TO 9200	
	Extension 250 cm	Price	Extension 250 cm	Price	Extension 275 cm	Price	Extension 275 cm	Price	Extension 300 cm	Price
S (215 - 230 cm)	42901	1581,-	429011	1581,-	—	—	429014	1744,-	—	—
M (230 - 245 cm)	42902	1581,-	429021	1581,-	429022	1744,-	429024	1744,-	429025	1853,-
DUC (230 - 250 cm)	42900	1581,-	42900	1581,-	—	—	—	—	—	—
FT (245 - 264 cm)	42924	1581,-	—	—	—	—	—	—	—	—
L (245 - 260 cm)	42903	1581,-	429031	1581,-	—	—	429034	1744,-	429035	1853,-
XL (260 - 275 cm)	42904	1635,-	429041	1635,-	429042	1799,-	429044	1799,-	429045	1908,-
XXL (275 - 290 cm)	42905	1690,-	429051	1690,-	429052	1853,-	429054	1853,-	429055	1963,-
3XL (290 - 310 cm)	42906	1799,-	429061	1799,-	429062	1963,-	429064	1963,-	429065	2071,-

Front walls

Awning width	300 cm	315 cm	325 cm	350 cm	375 cm	400 cm	425 cm	450 cm	500 cm	550 cm	600 cm
Heights S, M, L, XL	42915	—	429151	429152	429153	429154	429155	429156	429157	429158	429159
Price	633,-	—	687,-	687,-	742,-	742,-	796,-	796,-	916,-	971,-	1025,-
Heights DUC & FT	42919	42918	42920	42921	42922	42923	—	—	—	—	—
Price	633,-	687,-	687,-	687,-	742,-	742,-	—	—	—	—	—
Heights XXL, 3XL	42916	—	429161	429162	429163	429164	429165	429166	429167	429168	429169
Price	764,-	—	818,-	818,-	1548,-	872,-	927,-	927,-	1047,-	1101,-	1156,-

Curtain sets for Residence G3 - fabric color gray

Wide	Color grey	Price
350 - 400 cm	42912	250,-
425 - 500 cm	42913	272,-
550 - 600 cm	42914	299,-

Weights:

The weight for a complete tent in 300 cm medium is about 27.0 kg, at 600 cm Large approx. 35.5 kg.



Panorama awning also for FIAT Ducato with TO 6300 see page 164



Optionally, the side walls can be removed and replaced by mosquito nets



Black Silver White

Color combination

Panorama - Premium Complete awning tent for Thule Omnistor awnings

Awning-type	Mounting height of the awning (to lower edge of housing)	Awning width													
		300 cm	Price	350 cm	Price	400 cm	Price	450 cm	Price	500 cm	Price	550 cm	Price	600 cm	Price
8000	Medium (230 - 244 cm)	—		—		43182	3390,-	431821	3390,-	431822	3478,-	431823	3478,-	431824	3565,-
	Large (245 - 259 cm)	—		—		43183	3390,-	431831	3390,-	431832	3478,-	431833	3478,-	431834	3565,-
	Extra-Large (260 - 274 cm)	—		—		431835	3478,-	431836	3478,-	431837	3565,-	431838	3565,-	431839	3652,-
9200	Medium (230 - 244 cm)	—		—		43195	3565,-	431951	3565,-	431954	3652,-	431955	3652,-	—	
	Large (245 - 259 cm)	—		—		43196	3565,-	431961	3565,-	431964	3652,-	431965	3652,-	431966	3739,-
	Extra-Large (260 - 274 cm)	—		—		431967	3652,-	431968	3652,-	431969	3739,-	431970	3739,-	431971	3826,-
5200	Medium (230 - 244 cm)	431870	2867,-	431871	2954,-	431872	3042,-	431873	3129,-	431881	3216,-				
5300	Large (245 - 259 cm)	431874	2867,-	431875	2954,-	431876	3042,-	431877	3129,-	431880	3216,-				
	Extra-Large (260 - 274 cm)	—		—		431878	3129,-	431879	3216,-	431882	3303,-				
6002	Medium (230 - 244 cm)	43184	2867,-	431841	2954,-	431842	3042,-	431843	3129,-						
6200	Large (245 - 259 cm)	43185	2867,-	431851	2954,-	431852	3042,-	431853	3129,-						
6300	Extra-Large (260 - 274 cm)	—		—		431854	3129,-	431855	3216,-						

Panorama - complete awning for Opel Movano ≥ 2022, Fiat Ducato & similar

Awning-type	Mounting height of the awning (to lower edge of housing)	Awning width									
		300 cm	Price	315 cm	Price	350 cm	Price	375 cm	Price	400 cm	Price
5200	230 - 250 cm	431883	2867,-	431884	2954,-	431885	2954,-	431886	3042,-	431887	3042,-
6200	230 - 250 cm	—		431791	2954,-	—		431792	3042,-	431793	3042,-

Thule Panorama

Premium awning blind

- **High quality cloth material AIRTEX®**
made of 100% polyester, coated on one side with acrylate and teflon based impregnation. A fungicide coating prevents mold. It absorbs virtually no moisture and is water resistant and washable.
- **Easy assembly, high stability**
and neatly stowed away in 2 panniers. The front wall is pulled into the front profile of the awning. Side wall attachment is done with a clamping profile. With large window areas, the outdoor feeling is created. All sides are fully removable with zippers.
- **Intelligent ventilation**
via openings on both sides that allow perfect air circulation. Both side windows have mosquito nets.



Mosquito net inserts for Panorama

Mosquito net side wall	432736	332,-
Mosquito net front wall (for 400-600 cm)	432737	310,-

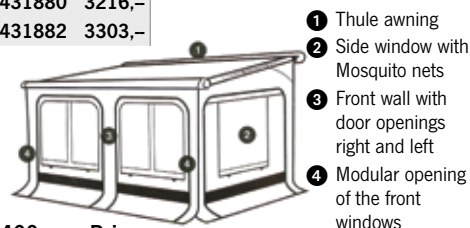

Awning Thule Veduta

Width 400 cm	431825	3369,-
Width 425 cm	431826	3456,-
Width 450 cm	431827	3456,-
Width 500 cm	431828	3543,-

- **Included**
The floor has a double windbreak to protect against dirt and rain. Wind skirt and wheel cover included. Two panniers.
- **Accessories**
Sun Blocker Page 176
Garda set 42914 299,-

Thule Veduta

Awning blind for caravan

Use only in combination with a roof awning TO 6300/6200 mounted on the caravan (mounting height 245-259 cm). With sloping front wall for maximum living space and extra sense of space.

- **Cloth material AIRTEX®**
AIRTEX® is ideal for awnings. The lightweight fabric (200g/m²) is made of 100% polyester and is coated on one side with acrylate and impregnated.
- **Versatility**
All window panels can be removed. One side wall has two integrated door openings for rolling up at the side. All windows are equipped with mosquito nets. The mosquito net is equipped with transparent covers that can be opened and rolled up by zippers. The front wall consists of one piece with two large windows.



Foam tape

seals space between vehicle and awning. 2 parts of 2 meters each. Closed-pored and self-adhesive. Dimensions: 25 x 30 mm
43292 57,80



Sealing rubber for TO 4200

For sealing to the vehicle. Can also be used with other awnings. With double adhesive tape. Length 400 cm **432805 69,80**

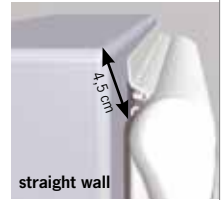
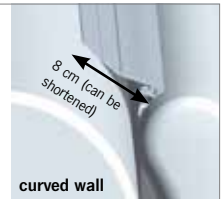

Sealing rubber for series 5 and 8

For sealing the gap between the vehicle wall and the awning, for awning installation with flat adapters.

Gcurved walls			Straight walls		
400 cm	432802	62,20	400 cm	432803	62,20
30 m roll	43295	344,-	30 m roll	432951	344,-

Omni-Gutter rain gutter

Multifunctional self-adhesive rain gutter. Length 350 cm **432806 67,60**
 Length 450 cm **43031 78,50**



from **85,10**

Panniers

2 bags in the set to store awnings tents, blockers or accessories. Dimension large bag: 120 x 20 x 30 cm, small bag: 120 x 20 x 20 cm **E4610 85,10**
 Panniers for stowing linkage and blockers. Dimension bag: 130 x 20 x 30 cm **42917 53,50**

Curtain sets for awnings awnings

Curtain sets for Thule Residence G3

Width B	Set gray	Price
350 - 400 cm	42912	250,-
450 - 500 cm	42913	272,-
550 - 600 cm	42914	299,-



Awning Tension rods round

to stabilize the awning. Also suitable as a receptacle for side panels. Aluminum (spring loaded and lockable).

Thule Tension Rafter G2 Aluminum for side wall awnings

200 cm for TO 5200/5003	432973	62,20
250 cm for TO 5200/5003	432974	64,40
275 cm for TO 8000	432975	73,10

for roof awnings

200 cm for TO 6200/6300	432976	62,20
250 cm for TO 6200/6300	432977	64,40
300 cm for TO 9200	432978	77,40

for caravan awnings

250 cm for TO 1200	432972	64,40
--------------------	---------------	--------------

Cloth clamps for tension rods

Clamps for a more secure attachment of the awning fabric on the tensioning or Blocker rod. Suitable for oval blocker-Tensioning bars, rafter G2 and square-Telescopic clamping rod TO 1200.

2 piece **430068 41,50**



Windbreaks for awnings

Drafts can no longer pass under the vehicle.

for B 325 cm	430760	88,30
for B 350 cm	430761	88,30
for B 375 cm	430762	90,50
for B 400 cm	43077	90,50
for B 450 cm	430771	92,70
for B 500 cm	43078	99,20
for B 600 cm	430782	103,-

Wheel cover orifice
430783 66,50

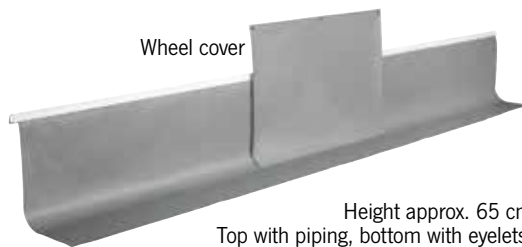

Wheel cover

Height approx. 65 cm
 Top with piping, bottom with eyelets.

Awning cleaner

Thule PVC cleaner

for cleaning awning cloths. Practical pump spray bottle. Content 500 ml. **E6100 10,90**
 GP 19,98/ 1 Liter



Awning cranks

Telescopic, from model year 1992
43159 66,10
for 6 series, adjustable 130-190 cm
43034 73,20
for awning 5102, foldable
43035 59,20



Retaining clips
for marker crank
2 piece **E283 11,20**

End caps

for TO 2000
White R **43142 18,-**
White L **E235 18,-**
for TO 5003
White R+L **E2673 15,10**
for TO 5102
Gray R+L **E2067 27,20**
Anthracite R+L **E5213 27,20**
for TO 5200
White R+L **E6507 27,20**
Silver R+L **E6457 27,20**
Black R+L **E8421 27,20**



for TO 8000
White R **E2878 15,10**
White L **E2875 15,10**
Silver R **E3206 40,30**
① Silver L **E3205 40,30**

End plates

for TO 5003
Right **SA1117 20,40**
for TO 5102
Right **E2186 27,20**
for TO 8000
Left **E2874 115,-**
① Right **E2877 43,90**



Clamping lever

for height adjustment at the awning foot incl. plastic cover.
For models until 2010,
2 piece **43158 12,60**
For models from 2010,
2 piece **E4181 15,20**



End caps

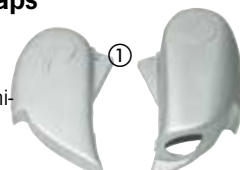
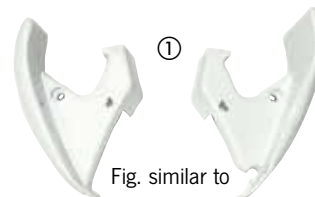

Fig. similar to
for TO 9200
① Silver R+L **E5577 30,60**
for TO CaravanStyle
2 piece **E7020 30,60**



Interlocks
for 5000/5002
43204 13,80

End caps front profile

for TO 2000
White R+L **E3651 13,60**
for TO 5003
White R+L **E3652 14,20**
for TO 5102
Gray R+L **E3476 16,-**
Anthracite R+L **E5363 16,-**
for TO 5200
White R+L **E6586 19,70**
Silver R+L **E10197 19,60**
Black R+L **E10284 19,60**
for TO 8000
White R+L **E2876 14,40**



for TO 6200
① White R+L **43144 19,70**
Silver R+L **E9630 19,70**
Anthracite R+L **E5482 19,70**

Support foot holder

for awning foot
2 piece
43157 24,60



Clips for Safari Room



6 piece **432030 15,50**
Bracing rubbers
4 piece **SA876 21,10**

Curtain rolls



for Safari Room
12 piece **E234 14,40**

Double keder rail

100 cm **E289 8,20**

Crank gear



① For TO 5002/5003/5200
43192 71,70
For TO 6200 and 6300
E9261 71,70

Repair kit

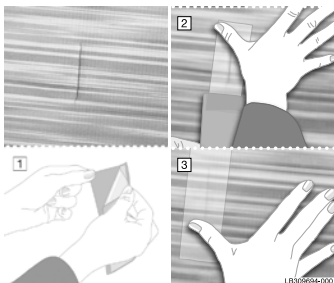

Repair adhesive tape for awning cloth.
5 pieces à 50 x 145 mm
432891 30,60

Rafter G2 end pieces

End pieces on the awning housing:
for TO 5200/5002/5003/4900/
5500/5800 **E5419 8,20**
for TO 8000 **SA702 6,90**
for TO 9200 **E8953 18,-**
for TO 6002/6900/6502/6802
E9210 7,55
for TO 1200 **E8539 22,60**
End pieces on the front profile:
for TO 5200 **E6833 11,80**
for TO 5003 **E4826 6,25**
for TO 4900 **E5511 8,75**
for TO 5002/5500/5800/8000
E8294 10,60
for TO 6200 **E5341 11,80**
for TO 9200 **E9242 11,80**
for TO 6900/6502/6802
E8294 10,60

More spare parts
at www.reimo.com

Housing colors

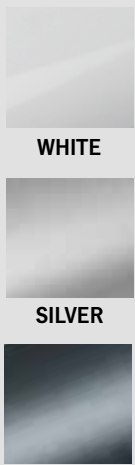

Cloth colors

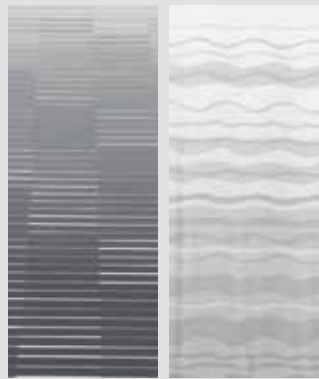

ANTHRACITE HORIZON GREY GREY WAVES



Roof awnings
Perfect Roof 2000 + 2500

Mounting adapter for Perfect Roof 2000 and 2500 roof awnings

Fiat Ducato from 2007

Series high roof H2

Ducato - Jumper - Boxer from YOC. 7/2006. Also suitable for Niesmann Bischoff Arto and Rapido V53 & V56.



3-piece for awnings up to W 400 cm **438570 130,-**
1pcs for awnings with W 375 cm **E3521 294,-**

PR 2000 - The compact

- Plastic end caps
- Support legs in the awning front rail
- Colorproof cloth without weld, one piece, waterproof, washable and rot-proof
- Ideal for Fiat Ducato

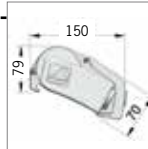

PR 2500 - Large excerpt

- Support legs with patented Easy Lock Flipper
- Aluminum end caps - shock and impact resistant

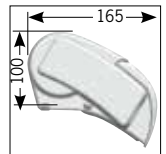

Perfect Roof 2500 - With aluminum end caps

Wide	375 cm	450 cm
------	--------	--------

Housing silver with extension 250 cm

Horizon Grey	447272	—
Price	926,-	—
Grey Waves	438483	438485
Price	1063,-	1089,-

Silver housing with large pull-out 275 cm

Horizon Grey	447332	—
Price	959,-	—

Sealing tape against Rainwater

Foam sealing tape for Sealing between awning and vehicle, self-adhesive.



W 30 mm, H 25 mm. 2 x 1,5 m **439060 38,10**

Perfect Roof 2000 - light and compact

Wide	350 cm	375 cm	400 cm
Excerpt	250 cm	250 cm	250 cm
Weight	25,0 kg	28,0 kg	31,0 kg

Housing White

Horizon Grey	447038	447039
Price	970,-	1111,-

PW 1100 - A classic

- Tension rod can be stowed away in front rail to save space
- Patented Easy Lock Flipper locks practical slide-out support legs in place
- Robust awning fabric made from one piece

Perfect Wall 1100

Wide	260 cm	400 cm	450 cm
Excerpt	250 cm	250 cm	250 cm
Weight	21,0 kg	30,0 kg	33,0 kg

Housing White

Horizon Grey	447391	44739
Price	926,-	1024,-

Housing anthracite

Horizon Grey	447395	447399
Price	719,-	1046,-



Wall awning
Perfect Wall 1100

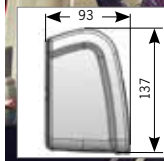

Vehicle-specific adapter for Perfect Wall 1100 wall awning

Dethleffs Globebus

Rail 4.00 m **438765 207,-**

Rapido 2007/8/9

4 plates à 2 x 16 cm & 2 x 8 cm **E2394 239,-**
3 plates à 1 x 100 cm & 2 x 8 cm **E2852 250,-**

Hymer Tramp, Hymermobile, Hobby Van, Hymer Exsis until 2007,

Rail 3.50 m	438754	174,-
Rail 4.00 m	438755	250,-
Rail 5.00 m	438757	272,-
Rail 5.50 m	438758	294,-

AWNING SEALING PROFILES AND TENSION RODS

Sealing profiles for Wall awnings

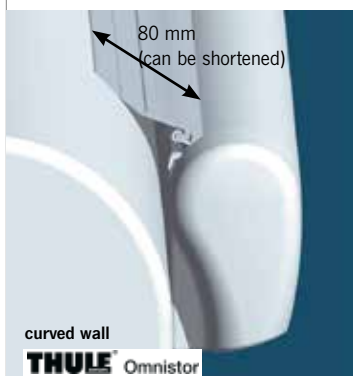

curved wall
THULE Omnistor

Thule sealing profile wide

suitable for wall awnings Thule Series 5 and 8.

400 cm **432802 62,20**
30 m **43295 344,-**

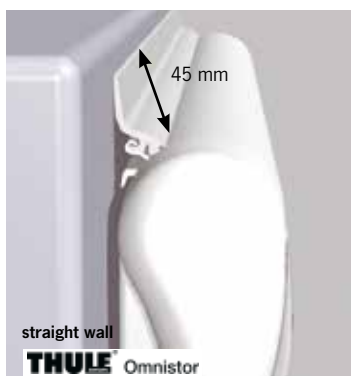

straight wall
THULE Omnistor

Thule sealing profile narrow

suitable for wall awnings Thule Series 5 and 8.

400 cm **432803 62,20**
30 m **432951 344,-**



Fiamma sealing profile Rain Guard L

For Fiamma awnings mounted with adapters protruding up to 9 cm or on strongly curved walls.

running metre **43485 12,80**
550 cm **434852 76,30**

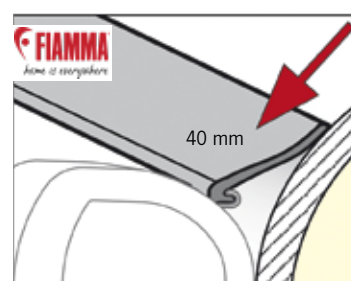

Fiamma sealing profile RainGuard M

For Fiamma awnings mounted with adapters protruding up to 4 cm or on curved walls.

running metre **43383 11,80**
550 cm **433831 67,60**

Sealing profiles for Roof awnings

for sealing between awning and vehicle, self-adhesive and closed-pore.

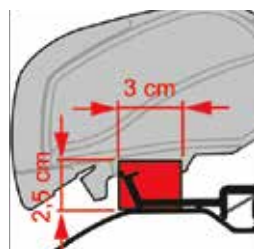

FIAMMA
Home of awnings

Fiamma foam sealing tape

Suitable for roof awnings Fiamma F80.

W 3.0 cm, H 2.5 cm. 450 cm
434851 51,10

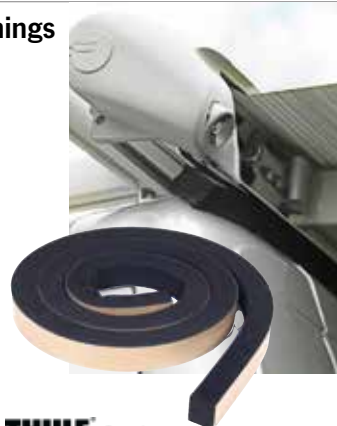

THULE Omnistor

Thule foam sealing tape

Suitable for Thule Omnistor 6300 roof awnings.

W 3.0 cm, H 2.5 cm. 2 x 200 cm
43292 57,80

Thule Tie rods round

to stabilize the Awning. Also suitable as a receptacle for side panels. Made of aluminum (spring loaded and lockable).



Thule Tension Rafter G2 aluminum for side wall awnings

200 cm for TO 5200/5003 **432973 62,20**
250 cm for TO 5200/5003 **432974 64,40**
275 cm for TO 8000 **432975 73,10**

for roof awnings

200 cm for TO 6200/6300 **432976 62,20**
250 cm for TO 6200/6300 **432977 64,40**
300 cm for TO 9200 **432978 77,40**

for caravan awnings

250 cm for TO 1200 **432972 64,40**

Fiamma tension rods - Rafter / Rafter PRO

- Increases the rigidity of the awning blind, better fabric tension
- For awnings up to 250 cm extension (adjustable from 142-265 cm)



Rafter straight

Rafter - straight tie rod

For F45 and F80

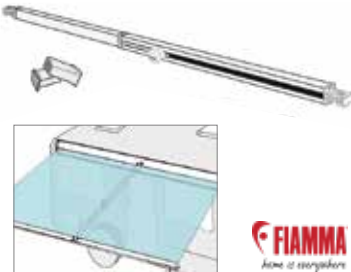

434554

FIAMMA
Home of awnings

59,50



Rafter PRO curved

Rafter PRO - curved tension rod

Additionally improves water drainage. Attention: do not use in intense sunlight. For F45 and F80

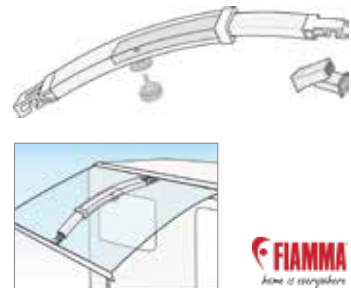

43315

FIAMMA
Home of awnings

84,-

Adapter F65 for Rafter and Rafter PRO

For older awnings F65 adapter is necessary to mount the rafter.

E4360

10,20



Rafter for caravan gate

aluminum with twist lock with extension 225-250 cm

434553

45,70

No drafts under the vehicle



For motorhomes,
550 x 60 cm, to close wheel recess,
can be shortened if necessary.
Fastening with press studs.
434381 123,-



Fiat Ducato from YOC. 6/06,
497x45 cm. Fastening with magnets
and rope tension. Suitable for all
vehicle lengths up to 636 cm.
434383 209,-



Volkswagen T5/T6/T6.1,
250 x 42 cm. Fastening with mag-
nets and rope tension.
434382 139,-

Inflatable windbreak



Just put under the car
and inflate. Supplied without pump.
Material: HD PVC.
L 250 cm, Ø 30 cm, approx. 3.2 kg.
Pack size: approx. 45 x 14 x 12 cm.
905991 141,-

You can find more wind screens on page 398 + 400



Awning security

Signal storm band

Band is easily visible in the twilight.
Suitable for awnings & tents for storm
protection.
Scope of delivery two-piece strap,
13 m, adjustable, 2 relief springs
94832 24,-



Peggy Peg Fix&Go AntiFlap

This awning clamp reduces the
annoying "flapping noise" almost com-
pletely. Widely projecting awnings can
be tightened even better with several
AntiFlap's per side. Fix&Go AntiFlap
is compatible with almost all awning
systems, whether with round, oval or
square rafter poles.
Contents: 2 Fix&Go AntiFlap, addi-
tionally needed: 2 rafters of awning
manufacturer.
94851 58,40



Peggy Peg TieStraps

For additional tensioning of awnings
and bag awnings in bad weather to
take strain off the folding arms.
Per piece 94846 14,80



Peggy Peg Fix&Go Bridge

The optional use of Fix&Go Bridge increases distance between the anchor
plate and the floor by 2 cm. The bridge-like design allows water to flow largely
unimpeded and dirt particles are simply flushed out. If required, Fix&Go
Bridges can also be stacked inside each other and the ground clearance
increased, of course also on fine sandy surfaces. Attention should be paid to
the length of the Peggys used. Content: 2 Fix&Go Bridges.
94850 9,20



Peggy Peg Fix&Go An-
chor Plate 2.0

Secure fixing of awning feet and tent
poles, no sinking into soft ground or
lifting off. The retraction of awnings
is possible. For all screw pegs from
Peggy Peg. **94828 15,30**



Peggy Peg Fix&Go
adapter buffer

NEW 2024
• Fixing of pole awnings, sun sails
etc. with Ø 18-27 mm
• Secure fastening on almost all floors
• Fits perfectly with Anker plate 2.0
• Insert buffer at the end of the bar
94858 10,90

Fix&Go Tube - Flexible 10 l ballast tank

As an extension to the Fix&Go anchor plate
for mounting on paving, concrete
or asphalt. Fix&Go Tube is light
and compact and becomes a
10 kg additional weight.
Application: Adapter plug-in shoe
onto the anchor plate. Hose
fill with water and place in the basket
then attach to the awning base with Velcro.
Attention: Fix&Go Tube does not replace an awning attachment to the ground!
Fix&Go Tube, 1 piece 94853 28,90
set of 2 Tube Pavilion: Design like Fix&Go Tube, but without adapter shoe.
Simply attach to the pavilion leg with Velcro. **948531 45,80**



Anchor plate 6 pcs

Universal mounting plates
Scope of delivery 2 anchor plates,
2 storm hooks, 2 Uni plates
94831 20,80



Croc adapter set of 4

Insert into piping rail and can be
used for hanging clothes hangers or
other items. Together with Crocodile
Peggy can also be attached a tensi-
on belt. 4 pcs.
94845 8,20

AWNING AND TENT GUY ROPES

REIMO TENT TECHNOLOGY

Guy set

- Storm band for awnings or awnings
- Complete set with pegs and tension spring
- Prevents the awning from blowing up

Length: 11 m	432882	11,90
Length: 14 m	432881	16,30
Protection set, open with velcro set of 3	43541	8,65

Belt width 4 cm

Storm protection - roof retaining strap XL

- Storm protection for awning or awning
- Extra sturdy design
- Belt length 12.5 m - extra long
- Prevents waving of the Awning or awning
- Complete with pegs and tension springs

43288	21,30
-------	-------

Storm lock for Thule Omnistor awnings

Hold Down Kit

Prevents the awning from blowing up. Fastening between articulated arms and awning cloth. 11 m long black strap with pegs, fastening material and bag. For awnings up to 6 m wide.

432860	41,50
--------	-------

THULE Omnistor

Hold Down Side Strap Kit

Attachment to the support legs. Also possible with awning blind. 2 straps, 3 m each, fixing material, pegs and bag. Not suitable for Thule Omnistor 2000.

432864	44,70
--------	-------

ROPESCOUT:

Luminous night markings

ROPESCOUT Floor marker

Perfect for marking the pegs. No more tripping over the awning tensioner at night.

set of 6	94798	13,80
----------	-------	-------

TIP

Storm protection for Fiamma awnings

LED WARNING SOLAR

- Securing the storm bracing in the dark

Scope of delivery: 2 LED lights with integrated solar battery for attachment to awning tensioning straps. Also fits into the keder rail of caravans and motorhomes.

432863	42,60
--------	-------

6 cm
7 cm
2.5 cm

Storm bracing TIE DOWN

- Protects in wind
- Stretch over the joint arms of the awning and anchor in the ground
- Belt length 11 m - for awnings up to 6 meters

Black	43286	27,80
Yellow	432861	28,40

FIAMMA
home is everywhere.

Storm bracing TIE DOWN S

- Secure attachment to the front panel of awnings F65, F45 + F35 and Caravan Store

Scope of delivery: 2 tensioning straps of 300 cm each, 2 ground pegs & 2 tensioning springs. Also fits into the keder rail of caravans and motorhomes.

F45/F65/F80 Black	432862	37,10
F45/F65/F80 Yellow	432865	37,10
Caravan Store	E4495	36,--

FIAMMA
home is everywhere.

Awning hanger

6 piece

Ø 5+7 mm incl. S-hook, for pulling into the keder rail of the awning

901274



6,50

Piping eyelets 5+7mm - 6 pieces

The eyelets have 5 mm piping on one side and 7 mm piping on the other. This makes them suitable for caravans, motorhomes, awnings and can be used multifunctionally, e.g. as a holder for storm lines, solar showers, utensil bags, coat hooks, etc.

set of 6

901693

5,40



For piping Ø 5 - 8 mm



Keder adapter

Suitable for attaching an awning to the front profile of the awning. Length 3 m, double piping Ø 5+8 mm

904493

34,40



2
PIECE



21,80

②

JUMBO
KLEMME

Anti-flutter clamps for awnings, sun sails, tarpaulins, etc.

- Easy to fix
- Also available as extra wide jumbo version
- Prevents fluttering noise
- Reduces damage

① 2 pieces with 1x short and long belt each	901276	14,20
② Clamp Jumbo 1 piece extra wide	901275	21,80

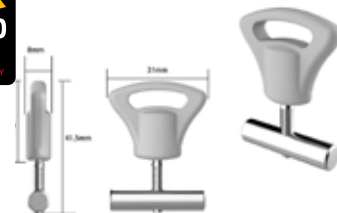

Locking piece Keder rail - set of 2

Prevents the keder from slipping out or shifting in the keder rail.

Ø 5 mm	901271	4,35
Ø 7 mm	901272	4,35

Locking piece keder rail

For keder strips with Ø 7mm, fixes your caravan awning, awning, sun awning or similar.

2 piece	901273	8,20
---------	--------	------



FROLI anchor plates, 2 pieces

- Securing tents, awnings, marquees, etc.
- Test load 200kg
- Made in Germany

2 anchor plates to secure tent, awning, Awnings & much more. Simply use the incl. screws in the floor. Available are additional points for attaching, e.g., dog leashes, boats & other camping accessories.

2 anchor plates (Ø140mm), 10 fixing screws (8x180mm)

94859	22,90
-------	-------



Roof rack sets by THULE can be found on page 622 + 623

① Railing for Thule Omnistor 6300

- Mounting without drilling
- Load capacity 100 kg

Roof rails / carrier incl. awning mounting adapter for Fiat Ducato, Peugeot Boxer & Citroën Jumper from YOC. 6/2006. For long wheelbase 403 cm (599 cm vehicle length) and standard high roof H2. Consisting of 2 x 3 support legs, 4 cross members. For Ducato from 2007 42155 1075,-

② Railing for Thule Omnistor 5003/5200

- Aerodynamic shape
- No drilling work necessary
- Optional crossbars in any number

Roof rail / carrier STYLE

For Fiat Ducato, Peugeot Boxer and Citroën Jumper from YOC. 6/2006. Aluminum. for wheelbase 403 cm 42151 1428,- for wheelbase 345 cm 42152 1428,-



③ Cross member, 2 pieces
100 kg payload/crossbeam pair, 200 kg max. payload. 421521 207,-

④ Awning mounting adapter for mounting a Thule Omnistor 5 series wall awning 421522 126,-



Rafter LED - Awning tensioning rod w/ LED

- With COB LEDs. Neutral light 4000 K, 13.5 watts
- Power supply via adapter cable with cigarette lighter plug
- For awnings up to 250 cm extension (adjustable from 142-265 cm)

Rafter LED for F45, F80s and F65	440685	130,-
Rafter LED CS for caravan gate	440686	130,-

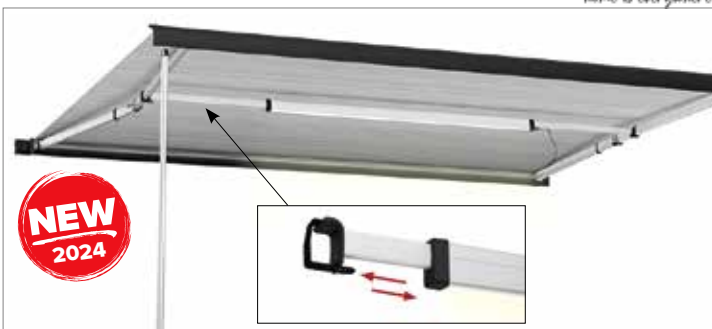

Rafter LED - Tension rod with LED

- Neutral light thanks to COB LEDs w/ 4000 K.
- Increases the tension between the two awning arms
- Prevents the formation of water pockets
- Incl. Connection cable for cigarette lighter

Rafter LED Van for F40van (270 cm), F43 (270 cm) and F45s (260 cm).		
13.5 W, weight approx. 1.35 kg	440687	130,-



LED lighting comfort w/

- 12 Volt LED Outdoor Light Cold White
- Mounting under the awning housing, also suitable for other applications (e.g. as door light, garage)
- With 31 LEDs

For lighting the outdoor area and garage. The average lighting time of an LED is 25,000 hours. Super Bright LED with ø 5 mm. Light tone 7000 ° K, 3.1 watts, cable length about 1.2 m.

Without motion sensor, Weight 0,4 kg **43532** **74,20**

With motion sensor, Light duration 60 sec., only lights up in the dark when someone approaches. Weight 0,5 kg **435325** **104,-**



LED Case for F70, F45S and F45L

Lighting set w/ 180 LEDs to be pulled into bottom groove of awning housing of F70, F45S or F45L. Basic set is for awnings w/ a width of 300 cm.

The individual light elements can be connected by pressing them together. The basic set can be extended as required with the extension sets.

LED basic set 250 cm	43598	160,-
LED extension set 50 cm	43599	39,30



Front profile lighting

- 12 Volt LED Awning Lighting
- 2 lights with 10 LED each
 - Including 5 m connection cable
 - Snaps into the front panel
 - 2.4 watts, 0.2 amps

43461	45,80
-------	-------



Self-adhesive articulated arm lighting

- 12V LED strip for articulated arms
- 4 light strips with 9 LEDs each
- To stick on

With cable guide 1.22 m long. Also for other applications. 4 W, 0,36 A. Dims.: L300 x D7 x W17 mm.

433591	104,-
--------	-------



Kit LED Strip

- 12V COB LED strip, 4000 K
- Flexible LED strips for gluing under the awning housing.

For Fiamma F43:
Length: 250 cm. 27.5 W. 0.5 kg **440684** **96,-**

For Fiamma F80:
Length: 500 cm. 55.0 W. 0.5 kg **440683** **125,-**



Cable duct kits

① **Kit Cables Rail:** two flexible rails. Ideal for folding arm awnings without a cable holder. Dimensions per rail: 13x3x1225 mm.

434612	23,-
--------	------

② **Kit Cables Guide:** two flexible profiles for fixing cables for awnings with cable holders. Dimensions per profile: 1225 mm, Ø 6.5 mm.

434600	14,30
--------	-------



①

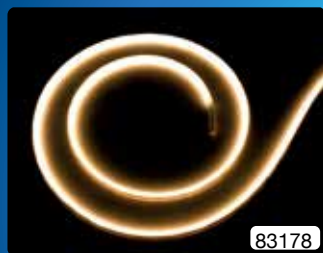

83178



12V



②

① Awning lighting

- Suitable for outdoor use
- Dimmable with dimmer (831003)
- Self-adhesive with M3 adhesive tape

LED Strip White 780 Lumen/m
120 LEDs /m, 12 V, 9.6 W/m. Dimmable. IP 67.
Strip width 10 mm. Can be shortened every 25 mm. Warm white 3000K.
500 cm **83170** **76,20**

LED Strip White 390 Lumen/m
60 LEDs /m, 12 V, 4.8 W/m. Dimmable. IP 67.
Strip width 7 mm. Can be shortened every 50 mm. Warm white 3000K.
500 cm **83171** **49,-**

LED Strip White 195 Lumen/m
30 LEDs /m, 12 V, 2.4 W/m. Dimmable. IP 66.
Strip width 7 mm. Can be shortened every 100 mm. Warm white 3000K. 500 cm
83174 **27,20**

LED strip white 620 lumen/m
150 LEDs /m, 12 V, 10.8 W/m. Dimmable. IP 67.
Strip width 10.5 mm. Self-adhesive.
Warm white 3000K.
500 cm **83178** **98,-**

② Radio remote control with dimmer
Remote control as a keychain.
Functions: ON / OFF / Brighter / Darker. Switching capacity 96 W, quiescent current app. 30 mA.
Housing dimensions: L90 x W60 x H37 mm.
831003 **21,70**

Awning light with 14 LEDs

12/24 volt DC 2.5 watt with plastic clamp, easily attaches to tent or awning poles. 5 meter cable and safety universal plug 2 A, fits DIN and cigarette lighter sockets. LED light does not attract insects. **81191 137,-**



12V

Self-adhesive LED flex tape

THULE Omnistor
Suitable for outdoor use. Can be shortened every 5 cm. Flexible, with self-adhesive 3M tape. 1 m connection cable. 60 Power LEDs/m w/ 340 to 380 mA/m. 12 volt. Waterproof IP66.

4 m length **433001** **106,-**
5 m length **43300** **139,-**
6 m length **433002** **161,-**



You can find more LED strips in the Electrical area

12V

LED flex ribbon, side emitting

THULE Omnistor
Special LED tape for above LED mounting rail. Side emitting, self-adhesive. Length 400 cm **43890** **139,-**

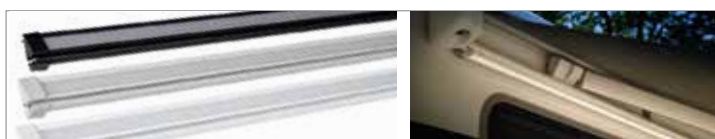

Tent and LED Mounting rail for TO 5200

for mounting under the awning. With keder rail for attaching tent EasyLink or QuickFit & mounting place for LED light strips.

300 cm, White	43149	130,-	400 cm, White	431495	141,-
300 cm, silver	431490	130,-	400 cm, silver	431496	141,-
300 cm, Black	431491	130,-	400 cm, Black	431497	141,-
350 cm, White	431492	130,-	450 cm, White	431498	147,-
350 cm, silver	431493	130,-	450 cm, silver	431499	147,-
350 cm, Black	431494	130,-			



LED mounting rails for Thule roof awnings

For mounting under the awning. Combines the mounting option of awnings with the simultaneous use of LED lighting. Without LEDs.

Set for TO 6200/6300 3 x 130 cm, anthracite. o. Fig. **43889** **67,60**